



DESIGN AND CONSTRUCTION OF  
**REINFORCED**  
CONCRETE BRIDGES

BY  
A. W. LEGAT  
M. INST. C. E.

G. DUNN  
M. A., B. Sc. (ENG.)

AND

W. A. FAIRHURST  
M. I. STRUCT. E.



PUBLISHED BY  
CONCRETE PUBLICATIONS LIMITED  
14 DARTMOUTH STREET, LONDON, S.W. 1

FOR A LIST OF OTHER  
"CONCRETE SERIES" BOOKS  
SEE PAGE 504 ●

|                                      |      |
|--------------------------------------|------|
| <i>First Published (5000 copies)</i> | 1915 |
| <i>Revised</i> . . . . .             | 1919 |



## PREFACE

THIS book deals with the fundamental problems of the design of reinforced concrete bridges of all types. It is the work of three engineers, each with decided opinions of his own on the matters dealt with in the chapters for which he has been mainly responsible, and it is thought that the work as a whole provides a reasonably balanced view of the subject.

The illustrations (except those in Appendix V and in Chapters XIII and XVIII) are mostly of works designed and constructed under the supervision of the writers and fortunately it has been possible to choose from a wide range of types. A great many lessons that have been learned during the design and construction of bridges have resulted in the improvement and standardisation of numerous details, and many of these are given in the drawings. In some cases complete plans and detailed drawings are provided to enable the student to form a good idea of sound drawing-office practice.

Almost all the elements of the design of bridges are dealt with, including the important problems of joints, surface finishes, drainage, and superelevation. Lack of attention to detail can easily spoil an important bridge which is fundamentally sound in conception and general treatment, and very few bridges so far constructed in reinforced concrete have been entirely free from defects such as efflorescence at construction joints or staining at expansion joints.

Only during recent years has very much attention been paid to the durability of concrete, although it is of primary importance in exposed structures such as bridges. Care must be taken to use high-quality concrete which will provide a high degree of workability with a low water-cement ratio. Only concrete mixed with a small proportion of water will withstand the effects of exposure to the elements, and a number of older concrete bridges need repairs which would have been unnecessary if the concrete had been of a reasonably high standard.

The appearance of bridges is now receiving much more attention than in the past, and details of all important works have to be submitted to the Royal Fine Arts Commission for approval and comment. This has resulted in an improvement in design and has ensured that no ugly bridge is now likely to disfigure the landscape. There will, however, still be a considerable disparity between the really beautiful structure and that of just sufficiently good appearance to obtain approval, as the Royal Fine Arts Commission cannot do more than suggest general improvements or reject a really bad design. The closest collaboration between the engineer and the architect is required to produce a bridge of really fine appearance, and a masterpiece is possible only when both engineer and architect are masters of their craft and work together in complete harmony. The engineer must possess sufficient æsthetic feeling and sensitiveness to appreciate the architect's ideas and proposals, and he must also be able to act as interpreter of the more difficult aspects of engineering requirements. No architect worthy of the name

would wittingly associate himself with a sham, and he must know how each part of the structure is acting before he can make any real contribution to the æsthetics of the bridge. Thus a girder bridge may have curved soffits to the parapet girders, but considerable delicacy of line must be employed to ensure that the structure does not look like an arch bridge with a low ratio of rise to span. The new Waterloo Bridge is a beautiful structure of the continuous girder type, but despite the use of beams with curved soffits only an observer completely ignorant of engineering design would mistake it for a series of arches. Where a bridge deck has to be curved on both plan and elevation the finest combination of engineering and architectural skill is required to avoid the many subtle æsthetic pitfalls which will present themselves, and a satisfactory design can be evolved only with the exercise of great care and knowledge.

Considerable discretion is required in choosing curves for the line of the road and the soffit of the bridge, and, even when they appear satisfactory in

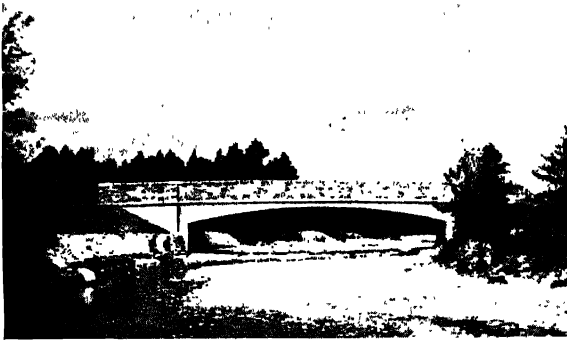

combination on the elevation, in the foreshortened view which is seen when approaching the bridge at an angle they may be most unsightly. A bridge which, to suit the conditions of the site, requires a rise towards the centre of the span with reverse vertical curves at the ends offers considerable difficulty in the choice of an harmonious curve for the soffit. It is necessary in such a case to avoid a soffit with a small rise-to-span ratio, and the choice is particularly difficult when it is desired to provide a satisfactory foreshortened elevation.

The small single-span bridge is always a difficult subject and very few small bridges erected during the past forty years have a satisfactory appearance. A pleasing example of this type of bridge is that constructed at Cawdor in 1936 and illustrated on this page. The curve of the soffit and the line of the road are in complete harmony and combine well with the charming setting. The old hump-backed type of bridge, with a high arched soffit, provided an eminently satisfactory combination of line of road and curve of soffit curve, but these and other matters connected with the æsthetics of bridge design are beyond the scope of this work. So far as we know there is no comprehensive treatment of the æsthetics of bridges.

Prestressed concrete has made considerable progress in recent years, and

many engineers and contractors have had experience of the design and construction of prestressed concrete bridges. This method of construction has greatly enlarged the possibilities available to the engineer. There are, however, considerable problems still to be faced, and it will be some years before a fair comparison can be made between the economy and durability of prestressed and reinforced concrete bridges. We have not attempted to deal with the theory and practice of prestressed bridges, as a large amount of information on their design is readily available elsewhere.

A chapter is included on estimating and a series of graphs is given to enable a rapid determination to be made of the costs of different types of bridges. These charts are based on prices ruling in 1955 and costs obtained from them may require to be adjusted to allow for subsequent variations.

A chapter is included on the difficult problems of strengthening, widening, and realigning old bridges. Very few writers have attempted to deal with these subjects and we feel that the present contribution should be particularly useful to those who have to deal with these problems.

We are indebted to F. A. Macdonald & Partners, Glasgow, for the use of a large number of drawings and photographs ; also to various members of their staff for valued assistance with illustrations and the checking of proofs. We are particularly indebted to Mr. Henry McClusky, who did a great deal of careful checking of the mathematical and arithmetical work.

The authors are greatly indebted to Mr F. J. Richardson for his assistance in the revision of the present edition.

GLASGOW.

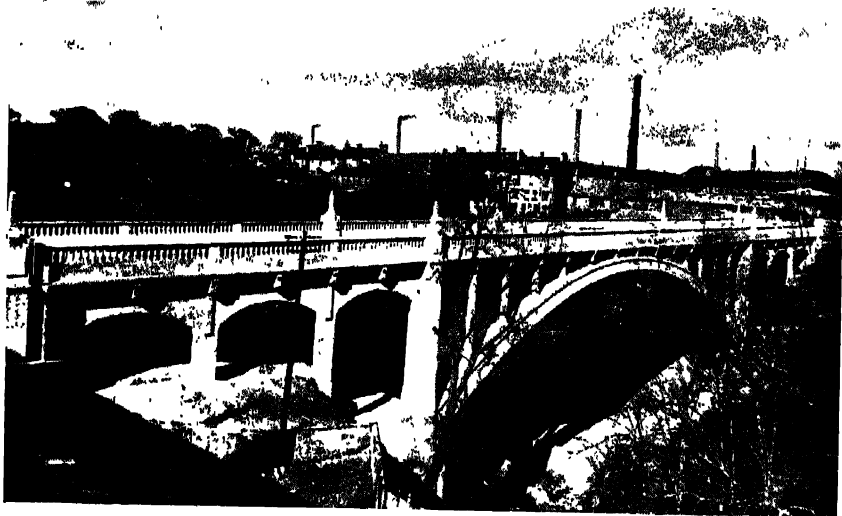

THE GLEN BRIDGE, DUNFERMLINE

# CONTENTS

|   | PAGE |
|---|------|
| CHAPTER I   |      |
| THE IDEAL BRIDGE . . . . .  | 1    |
| Bridges New and Old—The Purposes of a Bridge—Alignment of Bridge and Approaches—Strength—Size and Width—Permanency and Upkeep—Headroom—Appearance—Services—Road Surface—Road Drainage—Future Widening—Economy   |      |
| CHAPTER II  |      |
| SURVEY, LOCATION, AND SITE INVESTIGATION . . . . .  | 10   |
| Site Survey— borings and Trial Holes—Provision for Mams—Flood Level and River Flow—Accommodation Roads—Available Materials and Labour—Summary   |      |
| CHAPTER III   |      |
| BRIDGE TYPES AND CHOICE OF TYPE . . . . .   | 28   |
| Types Available—Foundations—Foundations Liable to Disturbance—Length—Loads—Width—Contour—Appearance—Typical Examples—Skew Spans   |      |
| CHAPTER IV  |      |
| DESIGN OF SLAB AND GIRDER BRIDGES . . . . .   | 52   |
| Freely-Supported Slab Spans—Ministry of Transport Loading—Pigeand's Theory—Slabs Continuous over Two, Three, and Four Spans—Slabs Supported on Four Sides—Single-Span Girder Bridges—Longitudinal Girders with Cross Beams—Girders Continuous over Two or more Spans—Varying Moment of Inertia—Girders with Hinges. |      |
| CHAPTER V   |      |
| DESIGN OF PORTAL FRAME BRIDGES . . . . .  | 134  |
| CHAPTER VI  |      |
| COMBINED THRUST AND BENDING . . . . .   | 147  |
| CHAPTER VII   |      |
| DESIGN OF ARCHES . . . . .  | 169  |
| CHAPTER VIII  |      |
| FOUNDATIONS . . . . .   | 197  |
| Bearing Pressures—Cofferdams—Piling—Examples of Bridge Foundations—Mass Abutments—Cellular Abutments.   |      |
| CHAPTER IX  |      |
| BRIDGE ARCHITECTURE . . . . .   | 234  |
| CHAPTER X   |      |
| STRENGTHENING, WIDENING AND RE-ALIGNMENT OF EXISTING BRIDGES .  | 247  |
| CHAPTER XI  |      |
| OFFICE PRACTICE . . . . .   | 267  |
| Routine—Draughtsmanship—Calculations and General Drawings—Detailing—Checking—Steel Sheets—Specifications—Bills of Quantities.   |      |

## CHAPTER XII

|                      |     |
|----------------------|-----|
| ESTIMATING . . . . . | 295 |
|----------------------|-----|

## CHAPTER XIII

|   |     |
|---|-----|
| CONSTRUCTION METHODS AND EQUIPMENT . . . . .  | 309 |
| Preliminaries to Construction—Estimating Contract Time—Plant and Arrangement of Plant—Cost Estimates—Construction Programme—Maintaining Traffic—Setting-Out—Excavation—Construction of Foundations—Filling. |     |

## CHAPTER XIV

|   |     |
|---|-----|
| STAGING, CENTERING, AND SHUTTERING . . . . .                                  | 338 |
| Terms Shuttering - Staging and Centering Examples of Shuttering and Centering |     |

## CHAPTER XV

|   |     |
|---|-----|
| REINFORCEMENT . . . . .                         | 356 |
| Ordering—Storing on Site—Bending—Welding—Fixing |     |

## CHAPTER XVI

|   |     |
|---|-----|
| CONCRETE AND CONCRETING . . . . .   | 372 |
| Cement—Sand—Coarse Aggregate—Water—Test Cubes—Proportioning—Mixing—Transporting—Placing—Curing—Remedying Defects. |     |

## CHAPTER XVII

|   |     |
|---|-----|
| SUPERVISION OF CONSTRUCTION . . . . .   | 392 |
| Duties of Resident Engineer—Excavation—Materials—Mixing Concrete—Fixing Reinforcement—Shuttering—Concreting—Curing—Measurement. |     |

## CHAPTER XVIII

|   |     |
|---|-----|
| SPECIAL FEATURES . . . . .  | 401 |
| Railway Bridges—Culverts and Subways—Precast Concrete Bridges—Jacking Arches—Temporary Hinges in Bridges—Permanent Hinges, Bearings and Joints—Drainage and Waterproofing—Wind Pressure on Bridges—Testing and Maintenance of Bridges—Plain Concrete Bridges. |     |

## APPENDIX I

|                                  |     |
|----------------------------------|-----|
| CONDITIONS OF CONTRACT . . . . . | 422 |
|----------------------------------|-----|

## APPENDIX II

|   |     |
|---|-----|
| SPECIFICATION FOR A TYPICAL BRIDGE CONTRACT . . . . . | 448 |
|---|-----|

## APPENDIX III

|                                       |     |
|---------------------------------------|-----|
| TYPICAL BILLS OF QUANTITIES . . . . . | 467 |
|---------------------------------------|-----|

## APPENDIX IV

|   |     |
|---|-----|
| PRICES OF MATERIALS AND WAGES IN 1955 . . . . . | 482 |
|---|-----|

## APPENDIX V

|   |     |
|---|-----|
| EXAMPLES OF REINFORCED CONCRETE BRIDGES . . . . . | 483 |
|---|-----|

|                 |     |
|-----------------|-----|
| INDEX . . . . . | 501 |
|-----------------|-----|

## CHAPTER I

### THE IDEAL BRIDGE

BRIDGES NEW AND OLD—THE PURPOSES OF A BRIDGE—ALIGNMENT OF BRIDGE AND APPROACHES—STRENGTH—SIZE AND WIDTH—PERMANENCY AND UPKEEP—HEADROOM—APPEARANCE—SERVICES—ROAD SURFACE—ROAD DRAINAGE—FUTURE WIDENING—ECONOMY

IN view of the increasing interest taken in the æsthetics of bridge design in Great Britain, in this chapter the features which may be expected in an ideal bridge are discussed and some examples illustrated by photographs.

Travelling along the roads of any developed country one passes over or under innumerable bridges, and it is instructive to consider the differences in them. Generally they may be divided into three main classes: Ancient; constructed before 1914 but not ancient; and newer bridges constructed since 1918. What are the main differences in these three types?

In the first place it will be noted that the ancient bridges usually form river crossings, and an important feature common to them is that such crossings are almost invariably at right angles to the stream regardless entirely of their convenience or otherwise with regard to the road. In consequence at both ends of such bridges there are frequently bends which are sometimes as much as 90 deg. (*Figs. 1 and 2*). Due to the fact that these bridges were mainly used by pedestrians and slow-moving horse and wagon traffic, the bends were not seriously detrimental in the days when these ancient bridges were constructed. But they are a serious danger on the roads under present traffic conditions, and in consequence such bends are avoided in modern bridge approaches. The reason for the square crossing was that it was both difficult and costly to construct a skew bridge in masonry. Every stone had to be set out separately and dressed to a somewhat complicated shape, as is indicated by the photograph of a typical example reproduced in *Fig. 3*. With modern constructional materials a bridge on a skew to provide ideal road alignment can be constructed at a cost very little in excess of that required for a square crossing and with equal simplicity, as is shown by *Fig. 4*.

The second point which strikes one is that the contours of the ancient bridges were not nearly so convenient as in later examples. In many cases the centre of such bridges is in the form of a "humpback," sometimes so steep on both sides that visibility from one end of the bridge extends only to the top of the hump, approaching traffic on the far side being completely obscured from view.

A third great point of difference is that ancient bridges are almost invariably far too narrow for present-day traffic. In many cases they provided for only one line of vehicles to cross the bridge at a time, and in some instances the bridge parapets were built out over the piers to form recesses into which

## REINFORCED CONCRETE BRIDGES



**Fig. 1.—An Ancient River Crossing.**

NOTE NARROW HUMPED BACK WITH RIGHT-ANGLE BEND  
COMPLETELY OBSCURING APPROACHING TRAFFIC



**Fig. 2.—Modern Bridge Replacing Above.**

A WIDE AND LEVEL CROSSING, PROVIDING AN  
UNOBSTRUCTED VIEW OF TRAFFIC

pedestrians could enter whilst vehicular traffic passed. It may be accepted as a general rule that a bridge is unsuitable for modern traffic unless it has a width capable of taking at least one footpath and two lines of vehicular traffic at moderate speed. For main roads, bridges are generally constructed with a total clear width between parapets of 40 ft., providing a 30-ft. roadway and two 5-ft. footpaths, but the minimum width of one footpath and a roadway for two lines of vehicles would necessitate a roadway approximately 18 ft. wide with a 5-ft. footpath, that is, a total width between parapets of, say, 23 ft.

Finally, and possibly the most evident difference to the layman, is the appearance of old and new bridges. The ancient structures still existing are usually built of stone, which called for an arch form of construction. The fact that ancient bridges are frequently more picturesque and pleasing to the eye than many of the more modern examples is surprising, because the use of the stronger materials—structural steel and reinforced concrete—now available permits of a more slender form of construction, and with increased slenderness one might reasonably expect a more graceful construction. Frequently this has not matured, and so it is often assumed that the ancient builders of bridges had a more artistic sense of form and proportion than later engineers.



## THE IDEAL BRIDGE



Fig. 3.—Typical Example of a Skew Bridge in Masonry.

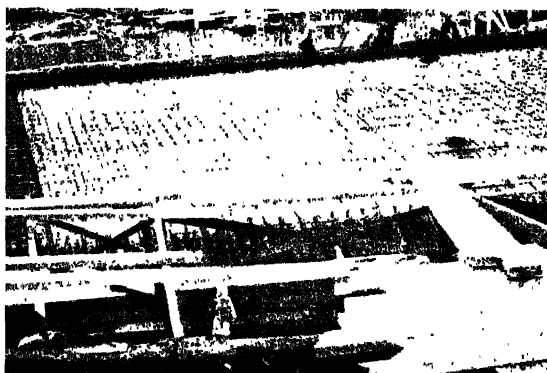

Fig. 4.—Constructional View of a Skew Bridge in Reinforced Concrete.

[COMPARE THE COMPLICATED CURVES AND CUTTING REQUIRED TO EACH STONE IN THE MASONRY ARCH WITH THE SIMPLICITY OF THE WORK IN REINFORCED CONCRETE.]

There is a very interesting example of ancient and "pre-1914" bridge construction on the northern outskirts of the Royal Burgh of Stirling. *Figs. 5, 6 and 7* show the three bridges which are to be found there. The first is Stirling Old Bridge, which was built several hundred years ago and is one of the most graceful and pleasing bridges in Great Britain; it is now listed as an ancient monument, and fortunately will be preserved by the nation. Downstream from this, and only about a hundred yards away, is the new road bridge, and a little farther downstream is a structural steel railway bridge. Looking at the three illustrations one cannot but be impressed by the fact that whilst the ancient bridge is unquestionably a stately structure, the present road bridge verges on ugliness. The railway bridge, on the other hand, whilst certainly



**Fig. 5.—Old Bridge, Stirling.**  
A BEAUTIFUL ANCIENT STRUCTURE.



**Fig. 6.—The Present Road Bridge at Stirling.**  
A TYPICAL STRUCTURE OF THE PRE-1914 PERIOD.

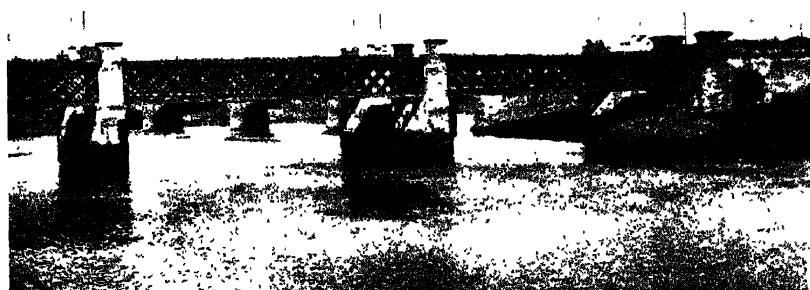

**Fig. 7.—Railway Bridge at Stirling.**  
A TYPICAL UTILITARIAN STRUCTURE; NOTE THE PIERS OF THE ROAD BRIDGES IN THE BACKGROUND.  
[THESE THREE PHOTOGRAPHS PROVIDE AN INTERESTING COMPARISON OF DIFFERENT PERIODS OF BRIDGE CONSTRUCTION. THE BRIDGES SPAN THE SAME RIVER WITHIN A DISTANCE OF 400 FT.]

not a pleasing structure, has the advantage that it is evidently purely utilitarian without any attempt at embellishment or decoration, and so provides some justification for its lack of artistry. It should be noted that the ancient bridge illustrates the points we have particularly mentioned. Its contour shows a pronounced hump-centre; its width is small, being only 13 ft. It is constructed of stone, and it is beautiful.

But whilst this particular example favours the ancient bridge so far as artistry is concerned, it is wrong to base on this and similar cases a sweeping judgment unfavourable to the æsthetic taste of the modern bridge builder. Many critics have apparently formed the opinion that ancient bridges in general are in themselves things of beauty and tend to improve the landscape. With this the writers disagree. It is in fact almost impossible to construct a bridge in any landscape without to some degree detracting from the æsthetic value of the countryside. Anyone doubting this should take a photograph of an ancient bridge considered to be beautiful and compare it with a photograph of the countryside adjacent to and similar to that at the bridge site, in order to obtain an idea of the view before the bridge was built. One case is illustrated (*Figs. 8, 9 and 10*), and we think it will be agreed that the bridge in question, whilst considered a "fine old structure," is undoubtedly out of harmony with its surroundings. Furthermore, the modern concrete bridge replacing it, whilst offering every advantage of road alignment, grade, waterway, headroom, and economy, has an appearance which will not suffer by comparison with the ancient structure.

Where opposition is encountered in arranging for the replacement of an existing bridge on this account, three views may be prepared: one a photograph of the existing bridge as it stands; the second a photograph with the existing bridge deleted and showing the view without the bridge; and the third a photograph with the existing bridge deleted and with the proposed new bridge drawn in. A well-designed structure of reinforced concrete would not emerge unfavourably from such a comparison.

Having discussed the differences between the old, the pre-1914, and modern bridges it will be well to consider the requirements for what one may term "the ideal bridge," so that in proceeding to design a new bridge one may blend the virtues of the ancient and modern forms of construction and omit their shortcomings.

In the first place the line of the ideal bridge should be such that it does not present any serious deviation from the line of the road at each end. Generally, of course, bridges will be in a straight line, but if the principles laid down are kept in mind there is no logical objection to a bridge itself being on a curve, provided always that the curve is of a radius not smaller than the general curvature ultimately to be adopted for other parts of the road, even when improved. The footpaths of bridges should have kerbs of reasonable height and parapets of sufficient strength to withstand a certain amount of collision shock in the event of vehicles mounting the kerb. As regards contour, it is far better that a modern bridge should be absolutely level, or at an even gradient similar to that of the roadway on both sides of the bridge, or if the bridge is long a slight camber throughout the length is permissible. The "hump" effect in ancient bridges to which we have referred tends to give a more



**Fig. 8.—Bridge at Hawkhead, Paisley.**  
THIS STRUCTURE IS GENERALLY CONSIDERED TO BE  
"A FINE OLD BRIDGE."



**Fig. 9.—View of the River without the Bridge shown above.**

NOTE HOW THE BRIDGE HAS SPOILT THE LANDSCAPE.



**Fig. 10.—The Reinforced Concrete Bridge replacing the Old Bridge.**  
IN ADDITION TO ITS GREATER CONVENIENCE, THE APPEARANCE OF THE NEW BRIDGE COMPARES FAVOURABLY WITH THE ANCIENT STRUCTURE.

picturesque appearance, but the purpose of a bridge is more important than its appearance, and all the other factors referred to should be made subject to the purpose for which the bridge is being constructed.

The width of the bridge should be sufficient to deal with any traffic likely to use it at the present time, or indeed for the next fifty to one hundred years. In most districts the minimum width for secondary roads should be 23 ft., giving an 18-ft. roadway and a 5-ft. footpath; for main road bridges a total width of 40 ft. is desirable, providing a 30-ft. roadway and two 5-ft. footpaths.

The next consideration is that of strength, and any main road bridge constructed to-day in Britain should carry with a reasonable factor of safety the Ministry of Transport loading (*Fig. 42*).

The third consideration is that of length and span. These, of course, depend entirely on the site conditions, and in every case it will be a matter for investigation on the part of the engineer to decide the overall length and span subdivision of the bridge. If the bridge crosses a stream it is essential that it shall not produce undue obstruction; in other words, it should provide a waterway through the bridge at least as great as the maximum waterway existing in the river or stream above the bridge. It is, in fact, somewhat desirable that this waterway area should be a little greater than in the stream above in order definitely to ensure that the bridge does not in any way offer obstruction, for if obstruction is caused there is not only a risk of damage to the structure but also a risk of claims from proprietors for the flooding of their land above the bridge. The positions of the abutments of the bridge require careful consideration, and, generally speaking, they depend entirely on where it is most economical to cease suspended spans and to change over to solid construction. The foundations must be adequate to carry the loads to be imposed on them, and sufficiently deep to avoid damage by floods or other agency.

Bound up with the question of span subdivision is the question of headroom below the bridge. Where the stream which is being crossed is not navigable, then the clear headroom to be provided depends entirely on the level of the highest recorded flood, above which a little clearance should be allowed. Where the waterway below is navigable and where the bridge does not provide an opening span it is necessary to ascertain what navigation rights exist in the river, and whether these provide for some minimum headroom under the bridges crossing it. If no such rights exist, then it is necessary for the engineer to ascertain the height of craft likely to use the stream and to provide a little clearance between this height and the underside of the structure.

The next question of importance is probably that of appearance, and this requires special care where the new bridge is to replace an existing structure of some beauty. It is generally an advantage to photograph the site and to sketch on the photograph the outline of the new scheme. This not only gives the engineer a better idea of his proposal, but is better than a drawing for indicating to the client the effect the new structure will have on the scenery and amenity of the site. Had a study such as this been made of some of the bridges built since 1918 a considerable modification might have resulted in the architectural treatment adopted. A further point to be kept in mind in that the bridge as a whole should fit into the surrounding landscape; in fact, perhaps the criterion of bridge construction on most sites, so far as the

roadway is concerned, is that one should be able to pass over it without having it impressed on one that a bridge is there. The parapets should be such that they blend with the surrounding scenery rather than obtrude themselves on the view of the user. So far as the side elevation is concerned it is of course impossible to design a bridge which is absolutely unobtrusive, but it is possible to design one which does not clash with the surroundings. This is one of the reasons why ancient bridges generally have found favour, for the materials of which they were constructed were really part of the countryside, the stone generally being quarried in the neighbourhood of the bridge. With the introduction of structural steel, brick, and reinforced concrete, the materials—or shall we say the chief material which is evident after the bridge is constructed?—is foreign to the countryside, and in order that they may be popular in their adopted country an endeavour must be made to make such materials unobtrusive and fit in with their surroundings without any sense of aggression.

The ideal bridge should also provide for services of gas, electricity, sewerage, water, telephones, telegraphs, and any similar work or line of connection which may be required. This is best done by forming a duct under one of the footpaths in order that the road traffic will not be interfered with during the laying of the services or during their repair when necessary. If provision such as this is made it avoids placing unsightly pipes and cables on brackets fixed to the outside of parapets. In considering this point it is not only necessary to consider existing services, but it is desirable to ascertain from the responsible authorities what are likely to be their future requirements and to make ample allowance for them. If it is found that a duct under one footpath would be insufficient to allow for all such services, then it is advisable to include ducts under both footpaths; the extra cost is a comparatively small item if the ducts are made part of the original design.

The road surface provided over the bridge should be similar to that of the roadway approaching the bridge at both ends; it is an advantage to adopt exactly the same type of road surfacing over the bridge as along the remainder of the road.

Ample provisions should be made for the drainage of the road surface. This may be done in several different ways, and is discussed in Chapter XVIII.

Sometimes it may be considered that, whilst a certain width of bridge will be sufficient for the time being, the surrounding district may develop to such a degree that a greater width may be required in the future. If so, this should be taken into account in the original design in order to avoid excessive expenditure and unsightly construction at any later date when widening is required. Some methods of providing for this will be described in a later chapter. In this connection it is interesting to note that in many older bridges which have been widened the engineer for the later work has for some reason or other considered that he could carry out the widening in a better manner by adopting a different form from that adopted by his predecessor. In general there is seldom justification for this where piers and abutments are being widened, and such a practice usually reacts on the public mind to the detriment of bridge engineering. The original bridge may not be a thing of beauty, but a widened structure where the new work does not conform to the old is often one of definite ugliness. Where piers and abutments are not widened but the increased width

of bridge is formed by cantilevering from the existing work, then some change in the elevation is justified and frequently essential.

The next consideration, and one of the most important always, is that of economy. By keeping economy in mind it is not necessary to sacrifice appearance, for frequently the most economical construction produces an appearance in itself artistic and pleasing; it does at any rate veto all the senseless embellishment which we find on some of the early reinforced concrete structures. The consideration of economy does not necessarily restrict construction to any particular material. There are cases of bridge construction where stone, structural steel, or brick is the most suitable material. Such an example might be a new bridge over a deep and very wide river providing a poor foundation; such a bridge would probably be more economical and of less dead weight if constructed in structural steel, especially the spans in the centre of the river. Many bridges constructed in recent years, however, are of reinforced concrete, which form of permanent construction economically provides all the features desirable in an ideal bridge.

## CHAPTER II

### SURVEY, LOCATION, AND SITE INVESTIGATION

SITE SURVEY—BORINGS AND TRIAL HOLES—PROVISION FOR MAINS—FLOOD LEVEL AND RIVER FLOW—ACCOMMODATION ROADS—AVAILABLE MATERIALS AND LABOUR—SUMMARY

AN engineer usually receives his instructions with regard to the construction of a new bridge from a county or borough engineer, from the council whom the engineer represents, or from some other authority. When the instructions are received, unless the engineer has already an intimate knowledge of the locality the first step should be slowly to traverse the road on which the bridge is to be built for a distance of a mile or two on each side of the proposed site. This will give the "atmosphere" of the countryside, and will create an impression of the general treatment most suitable for the bridge in question before the engineer becomes involved in details.

Having done this, the engineer might with advantage obtain the Ordnance Survey sheet covering the site of the proposed structure on which to study the general features and arrangement on both sides of the bridge, with particular reference to side roads converging on to the road which the proposed bridge will carry. This study will in itself probably enable him to settle the approximate site of the bridge and the length of roadway at each end which should be included in the detailed survey.

As an example *Fig. 11* shows a plan of a bridge site. It was decided to replace the old bridge by a new structure giving better gradients and adequate strength, and eliminating the dangerous narrow bends at the approaches to the old bridge. The site was visited and routes Nos. 1, 2, and 3 considered. A study of the map, however, showed a further route, No. 4, to be ideal; this eliminates all bends by substituting one wide sweeping curve, and greatly improves the town by opening the view across the valley from the main street looking north. In addition it reduces the amount of property to be acquired, and avoids the necessity for the temporary bridge required by routes Nos. 1 and 2.

The engineer should next obtain permission from the proprietors and adjoining proprietors to make the detailed survey. This frequently avoids friction resulting from surveyors trespassing on ground which, although it may be required for the scheme they have in hand, actually belongs to others for the time being. It is an act of courtesy which is sometimes overlooked and which may avoid initial friction. It is extremely desirable in work of this kind that the adjoining proprietors and the local population should be well disposed to the scheme, as in numerous ways they can often facilitate the execution of the work.

Having obtained permission, the detail survey of the site should be put in hand. It should include the preparation of a detail plan to a scale of not less



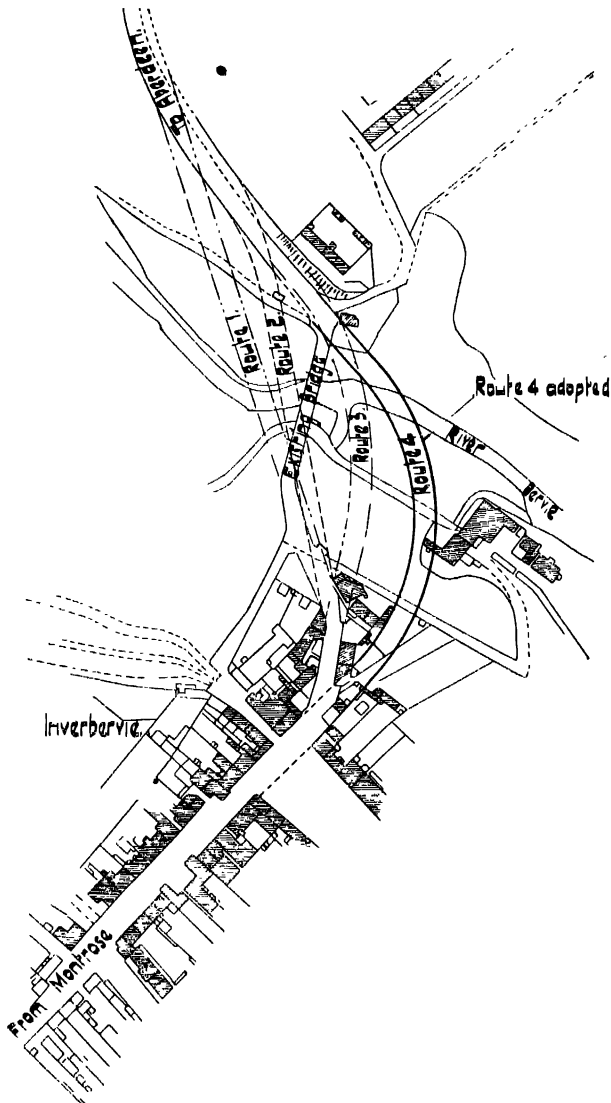

Fig. 11.—Study of Bridge Location from Ordnance Survey.

than 8 ft. to one inch, together with longitudinal sections along the centre line, and at least along each face line of the bridge. Cross-sections should also be taken at regular intervals and should particularly include the lines on which the abutments and piers are likely, from superficial examination, to be founded. In the case of a river, not only should the cross-sections include the actual width

of the bridge and a short distance on each side, but they should be carried sufficiently far downstream or upstream to disclose the deepest part of the river in the vicinity. The survey should extend at both ends of the bridge to include any road junctions and corners which may occur in a distance of two or three hundred yards from each end of the bridge. It is only by the consideration of such a length of roadway that one is able to choose the most suitable line, level, and perhaps gradient for the bridge. The survey should also include the whole of any property the purchase of which may be made necessary by the new scheme.

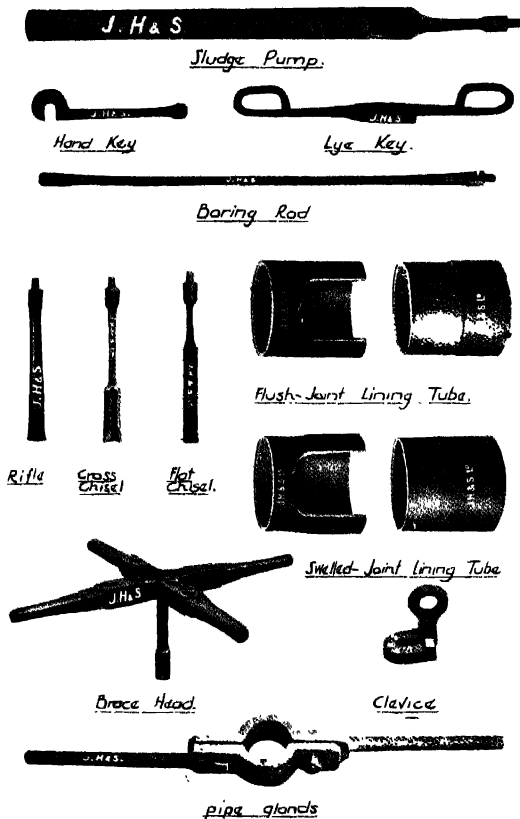

Fig. 12.—Hand Boring Tools.

Whilst the surveyors are on the site they should note the surrounding scenery. It is advisable also to take photographs from both upstream and downstream sides of the bridge and from both ends of the roadway approaches. These photographs may be of any convenient size not less than 3 in. by 2 in. ; if they are as small as this it is better to obtain enlargements from them to be used for the purpose of sketching in the new bridge to show approximately the appearance the site will present after the bridge has been constructed.

### Borings and Trial Holes.

The nature of the ground should also be ascertained. There are three main ways of doing this. The first and possibly the simplest is to ascertain what sub-soil has been found under structures in the vicinity. Mere hearsay should not be accepted, but if possible one should consult the builders of such structures, the responsible engineer, architect, or foreman, and ascertain the particulars from them. Trial pits should be dug at suitable points such as the positions likely to be occupied by the main abutments and piers. These trial pits should be carried down to such depths, say, 3 ft. minimum, that they show definitely ground suitable for foundations, and from this depth tubes or crow-bars may be driven to ascertain the nature of the ground to a further depth of, say, 6 ft. The actual thickness of a stratum to make it suitable for a sub-foundation, even if overlying different and poorer material, depends on the nature of the sub-foundation and must be judged in each case.

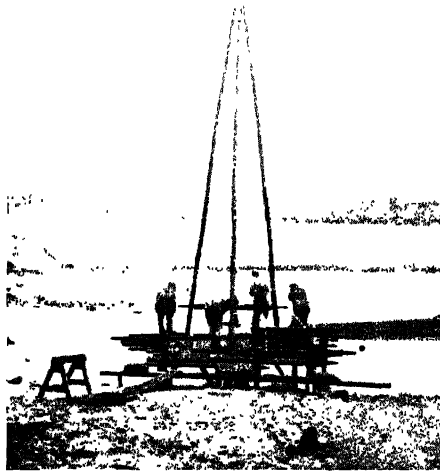

Fig. 13.—Hand Boring Plant.

In more important structures this more or less shallow investigation is insufficient, and it will be necessary to take trial borings to ascertain the nature of the ground for a considerable depth. For engineering work on land there are three general ways of taking such bores. The first is with apparatus worked only by hand, consisting of a boring auger with rods and drills of different types and lining tubes. The holes bored are usually from  $2\frac{1}{2}$  in. to 4 in. diameter. The boring contractor should withdraw and preserve samples of the materials extracted from each level. *Fig. 12* shows the type of boring equipment used and the various kinds of drills required. *Fig. 13* illustrates boring operations in progress. The logs of such bores should be recorded in a clear form, and the engineer should always see the material brought out, adding to the boring contractor's description any notes which may be necessary to provide an accurate and permanent record of the types of ground encountered. It is necessary in considering the samples of ground extracted to keep in mind that if ground water is encountered the samples brought up are likely to be softer and more

disintegrated than the material existing in its natural bed. In addition, water is often introduced into the bore-hole to facilitate the working of the tools, and the nature of the cores obtained is thereby affected to some degree. The cost of carrying out such hand boring varies considerably, and depends on the rate of wages, the depth of the bore-hole, and the type of ground. This method can be adopted in all soils and to depths up to about 50 ft. ; hand boring can be carried 2 ft. to 3 ft. into rock, although this is a laborious and expensive process and one which should be avoided wherever possible.

Where larger and deeper bores are required the tools become too heavy to handle direct, and a tripod and winch are used as illustrated in *Fig. 14*. The boring is done by raising the boring tool, using the winch as shown on the photo-



**Fig. 14.**—Winch Boring in Progress.

graph, and dropping it from varying heights depending on the nature of the material encountered. In both hand and the winch boring methods the bore-holes require to be lined temporarily with steel tubes in most types of soil, these tubes being withdrawn after the bore is completed when the hole may be permitted to fill up. Both methods are expeditious, and in most types of ground it is possible for the boring squad to pass through about 25 ft. of ground in the course of a working day of eight hours. In most cities there are one or two boring contractors who specialise in this class of work, and they are to be found in all mining districts. Where the engineer has any difficulty in finding a suitable boring contractor locally he will usually find that artesian-well engineers have the necessary plant and will be prepared to undertake the work.

In general, it may be said with regard to investigations as to the nature of

the ground that trial pits give the most reliable results, permitting, as they do, an examination of the strata in their natural condition and around all sides of the pit. They may be used economically for depths up to about 20 ft., depending on the type of ground and the amount of water present; bores may be used for depths of 20 ft. or more. A complete record of the bores taken for a particular bridge is shown in *Figs. 15, 16 and 17* with the levels at which the materials were ultimately found in the excavation. In general these results are more accurate than bores usually provide. Bores cannot be absolutely depended upon, and in designing foundations the engineer should make adequate allowance for contingencies in the event of his having to go deeper than the bores indicate or striking hard material at higher and inconvenient levels.

Where a site consists of a valley having steeply-sloping sides but a comparatively flat bed, special care should be taken in investigating the ground conditions. It is probable that the original valley would be considerably deeper, consisting often of a ravine resulting from the continuation downward of the slopes of the two sides. The portion forming the existing flat bed may simply

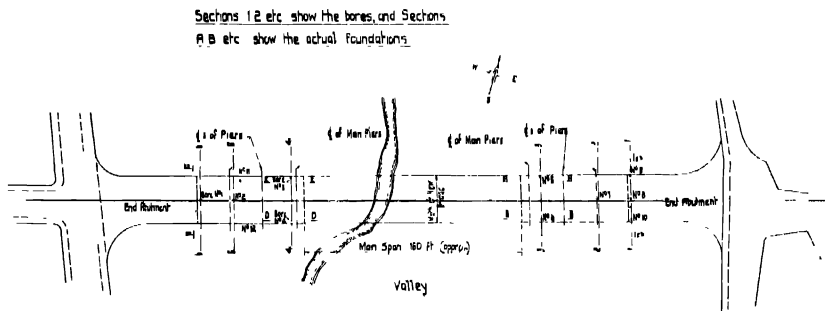

**Fig. 15.—Site Plan of Bridge showing Position of Bores.**

SECTIONS AND LOG OF BORES ARE GIVEN IN FIGS 16 AND 17.

be debris deposited in the original ravine, which, whilst appearing solid at the surface, may be quite unstable below. This is particularly the case in such valleys near the sea, where successive layers of shingle, sand, and soft alluvial clay are often found to considerable depths (see *Fig. 18*).

### Loading Tests on Ground.

Load tests on the ground may ultimately be required, but these are often comparatively expensive, and it is frequently difficult to arrange for them at the depth of the finished foundation until such time as the contractor is on the site and has excavated one or more of the foundation holes. In most cases it is possible to defer or avoid the making of load tests, the engineer basing the design on his experience of the intensity of loading capable of being carried by the ground disclosed by the pits or bores.

The simplest test is made with a timber sole-plate 1 ft. or 2 ft. square placed at the bottom of a trial hole. A timber post bearing on the centre of the plate carries a loading table and is guyed to prevent tilting. The weights of the post,

REINFORCED CONCRETE BRIDGES

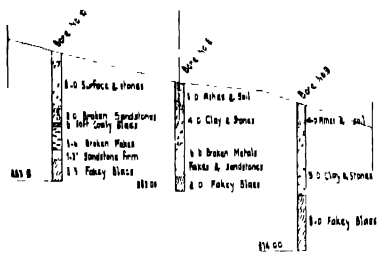

CS 1-1.

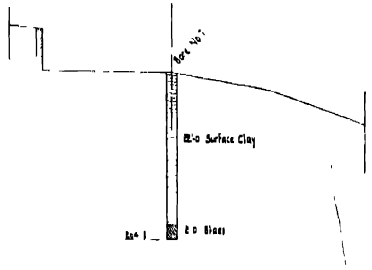

CS 2-2.

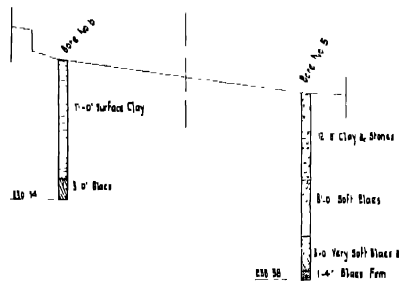

CS 3-3

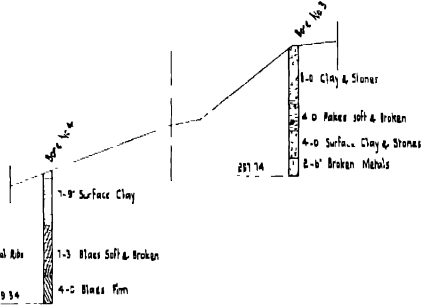

CS 4-4

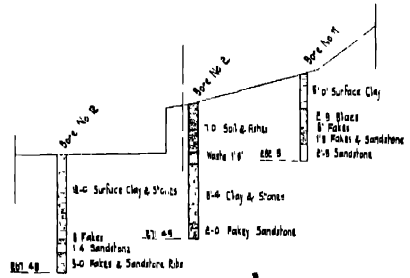

CS 5-5.

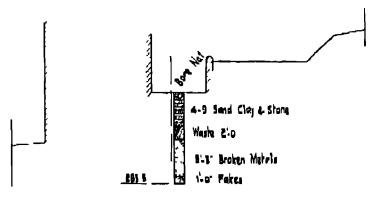

CS 6-6.

Fig. 16.—Sections showing Bores.



plate, and table, and of each increment of loading, should be accurately determined. A similar, but improved, apparatus is shown in *Fig. 19*. A pit 10 ft. to 15 ft. square is excavated down to the proposed foundation stratum, and a smaller pit, say 3 ft. square, is sunk about 2 ft. farther. The sides of the main excavation may need to be timbered, but in moderately firm ground it may not be necessary to sheet the smaller pit. If water is encountered, it should be drained into a sump provided in one corner of the main pit from which it can be pumped. The bottom of the smaller pit should also be kept dry, but in so doing care must be taken not to disturb the surface upon which the bearing plate rests. The testing apparatus consists of a metal sole-plate, say 2 ft. square, on which rests a metal spindle with a cast-iron cap supporting a steel or timber cross-head carrying the load. The ends of the vertical spindle are hemispherical and bear in cups on the sole-plate and cap, thus ensuring vertical reactions. The spindle passes through a guide in the frame, on which packing can be placed to support

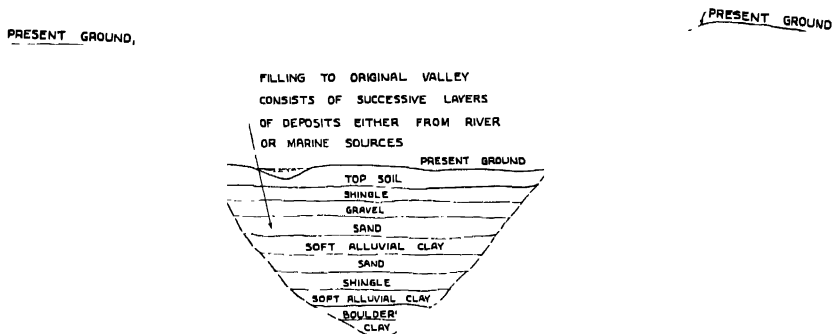

**Fig. 18.—Sketch Section of Typical Valley having Steep Sides and comparatively Flat Bottom.**

the cross-head should the latter become unbalanced. Otherwise throughout the whole of the test the cross-head is carried entirely by the spindle. Settlements are read on the extremities of the cross-head with a surveyor's level; a vertical graduated scale attached to the cross-head enables a rough check on the settlement to be made.

### Mineral Workings.

Another important factor which should be ascertained during the survey is whether there are coal or other mineral workings below the site likely to affect the stability of the bridge. One cannot too greatly stress the importance of this, for not only does it affect the possible permanency of the structure but it has a radical influence on the design to be adopted. If the bridge is to be founded on permanently stable ground, its type can be different from that on a foundation over coal workings which are almost certain to sink in the course of years. In the latter case the bridge foundations and complete superstructure must be made as flexible as possible to permit of the greatest relative movement between the various piers and abutments without damage to the bridge. This consideration will be dealt with at length later.



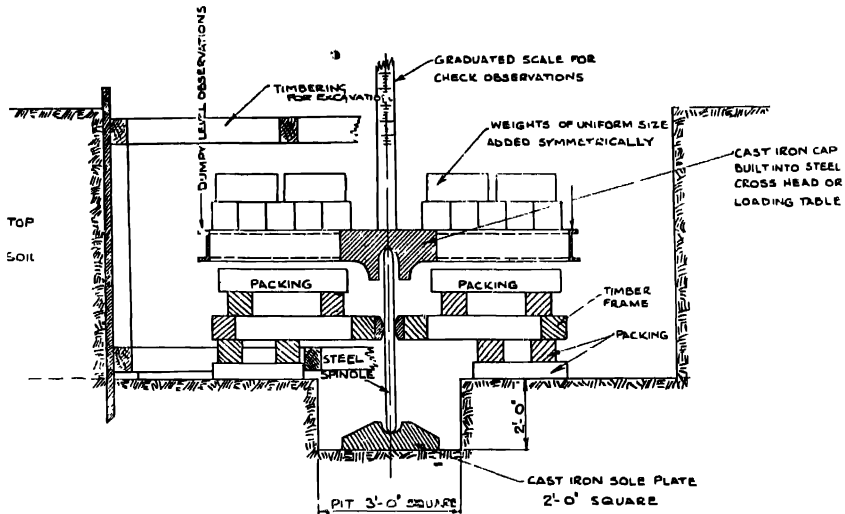

Fig. 19.—Method of Testing Bearing Capacity of Ground.

#### Provision for Mains.

An investigation concerning the existing services across the bridge and future requirements should be made in the course of the survey. This can be done by reference to the engineer of the local authority who will usually be able to give information regarding sewers and water mains to be accommodated. The gas engineer for the district will be able to give similar information regarding gas mains. Reference should also be made to the Post Office authorities to ascertain what provision is required for telephone and telegraph cables. Frequently, also, overhead telephone and telegraph wires occur in positions where they will obstruct cranes, pile drivers, and similar plant during construction. In such cases a temporary diversion may be necessary, and as this takes some little time to arrange special note should be made of it. Finally, the engineer of the company operating in the district will give information about electric cables; this point is particularly important—since there is a possibility of development going forward in electrification schemes it is probable that electric power will be introduced into a number of rural districts in the future. In discussing all these services with the competent authorities, the engineer should realise that he is not only providing a bridge for the present but for the future also, and that, whilst it is a simple matter to make provision for the mains when the bridge is being constructed, it may be difficult to lay those required in the future if they are not provided for in the original design.

#### Flood Level and River Flow.

A further point requiring special notice in cases where the bridge crosses a stream is the probability and height of floods. As a general rule the "highest known flood" level can be established by reference to old inhabitants or old

records. Failing this, a journey along the stream will frequently produce evidence in the form of debris deposited by floods and consisting usually of straw, grass, or twigs caught up in the bushes or undergrowth. More definite information about the highest flood is desirable, however, as this will have considerable bearing on the general plan adopted in design and construction of the bridge. It is also of interest to ascertain the speed with which floods develop in a river. Not only has this relation to the velocity of flow against which the bridge piers will require to be protected, but it may have some bearing on the design of the bridge in order to facilitate construction under particular circumstances. For example, in the case of a river liable to rise several feet in the course of an hour it will be appreciated that if timber centering were to be used considerable risk would be entailed throughout the whole course of the construction. Evidently if the river were to rise at such a speed when the whole of the centering was in position it would probably bring down with it branches, trunks of trees, and other large objects, and might also produce scour in the obstructed bed and cause considerable damage to the temporary work. Not only would this be a serious risk for the contractor, and one which would increase the cost of the work, but it might prove seriously detrimental to the permanent structure. Such a case calls during the design of the work for special consideration of the method of construction suited to the conditions. Another point to note is the size of the stones or boulders deposited by the stream, since these give an indication of the velocity in time of flood. An opinion should also be formed regarding the possibility of the stream changing its course. If there is any tendency to do so the foundations of the new bridge will require additional attention, and it may be necessary even to include in the scheme the training works necessary to ensure that the stream will keep to its course in the neighbourhood of the bridge. *Table I* indicates the velocity of flow which will induce movement in various types of material in a stream bed.

TABLE I

| Composition of bed.             | Least velocity (ft. per second) causing scour |              |                  |
|---------------------------------|---|--------------|------------------|
|                                 |   | in velocity. | Bottom velocity. |
| Slimy earth or brown clay . . . | 0·5   | 0·4          | 0·25             |
| Clay . . . . .                  | 1·0   | 0·8          | 0·50             |
| Firm sand . . . . .             | 2·0   | 1·5          | 1·00             |
| Pebbly bed . . . . .            | 4·0   | 3·0          | 2·00             |
| Boulder bed . . . . .           | 5·0   | 4·0          | 3·00             |
| Conglomerate of slaty fragments | 7·0   | 6·0          | 5·00             |
| Stratified rocks . . . . .      | 8·0   | 7·0          | 6·00             |
| Hard rocks . . . . .            | 14·0  | 12·0         | 10·00            |

Where the new structure is located immediately downstream of an existing bridge, information should be obtained regarding the levels to which scour below the existing bridge has developed. This is an important factor, for it will often be found that, whilst the bed immediately under the bridge is normal, there will be at least potholes formed in the bed a little way downstream. This may necessitate deepening and a considerable increase in the cost of the foundations

of the new work and some expenditure on works to prevent scour between and around the new piers.

Where the river is tidal it is desirable to take a tide record over a period of neap and spring tides and to arrange this so that it may give the contractors tendering for the work an indication of the length of time which they are likely to have available at each tide for construction at different levels. A tidal chart of this type made for a river which is partially tidal at the site of the bridge to be constructed is illustrated in *Fig. 20*. This site is at such a point in the river that it is subject to some tidal influence, but not entirely beyond the influence

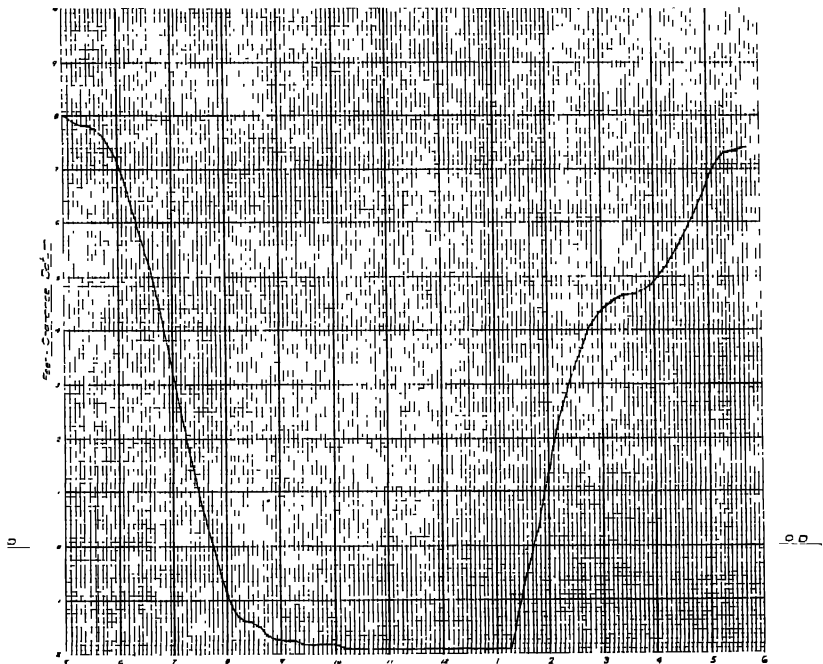

Fig. 20.—Typical Tide Graph for Partially Tidal River.

of flood water coming down the stream. In this case, as will be seen, there is a low-water period of approximately five hours to be expected at each tide. The exhibition of this chart to the contractors showed that the tidal work could be carried out under favourable conditions, and so enabled them to adopt a scheme for the execution of the work which permitted more economical construction than otherwise would have been the case.

A further point for consideration is the drainage of the filling which may be required over the bridge superstructure and between the approach walls and the abutments. This is important, since considerable surface water may collect in these places before the impervious road surface is laid. Not only does

this surface water tend to produce an unstable filling, but there is every likelihood that if it collects in large quantities it may percolate behind the abutments and affect the foundations of the work. To avoid these risks it is desirable to provide effective field or rubble drains behind the points in question, and to collect this water and discharge it through the abutments or approach walls and lead it away to a suitable point a little distance from the bridge. If the bridge crosses a stream it is an easy matter to provide this, but in other cases special measures such as, for example, a drain from the bridge to a nearby stream may be necessary. In addition to this more or less temporary surface drainage of the bridge, there will also be the permanent surface-water drainage from the road and footways to take into consideration. If the bridge is about 200 ft. long it will be possible to lead the surface water to each end of the bridge and there discharge it into a suitable stream or lead it to a soak-away. If, however, the bridge exceeds 200 ft. long it may be necessary to make provision for discharging this water through the deck of the bridge, or to lay a drain throughout the whole length and collect the water from the various gullies and carry this to the two abutments. This, however, is a somewhat expensive and cumbersome way of dealing with the matter, and, if at all possible, it is more economical to discharge the surface water at points along the length of the bridge. The engineer should keep this requirement in mind and make sufficient notes to enable him to decide in preparing the scheme what is the best and most economical method of dealing with it in each particular case. Drainage is also discussed in Chapter XVIII.

#### **Accommodation Roads.**

The line of the new bridge and approaches may cross certain existing services as, for example, an accommodation road. In such a case reference should be made to adjoining owners to ascertain what rights they have along such accommodation road and what headroom and width it is necessary for the engineer to provide. This in some cases may involve building a culvert or tunnel through the approach to take the accommodation road, a factor which may appreciably affect the ultimate design. In addition, to provide sufficient headroom for the accommodation road and still keep the highway over the bridge at a reasonable level it may be necessary to regrade the accommodation road and take it to a different level immediately under the new bridge. To provide for this contingency the engineer should continue his survey for some little distance along the accommodation road on both sides of the bridge so that he may arrange the regrading in a way satisfactory to the users of the accommodation road. When the bridge, in addition to crossing a stream, involves approach works which cross an adjoining mill stream, full information should be obtained concerning the depth and flow of water and the possibility of the mill owners above the bridge closing down the stream at certain times and so permitting any work over it to be carried out in the dry. In other cases footpaths may exist along the stream, and it may be somewhat difficult, particularly in an arch design, to arrange the bridge in a suitable manner to cross stream and footpaths in one span. In some cases it may be possible to provide for the foot traffic by arranging for steps on both sides leading up from the ground below to the road over the bridge, an arrangement which is often made. In other cases, however, it may be necessary to form a tunnel or culvert under the bridge abutment to provide for this traffic.



If the new bridge is away from the site of an existing bridge, or if the work is a widening, this is not difficult. If the new line crosses the site of the old bridge and the roadway cannot be closed a temporary bridge may be necessary, but this is expensive and should be avoided whenever possible; such temporary works form an additional charge on the new bridge without providing any permanent future facility. An interesting example of provision for keeping open the roadway over an existing bridge during the construction of a new bridge is given in *Fig. 21*. The roadway to be accommodated is an important main road which it is impracticable to divert. In addition the valley crossed by the existing bridge and to be crossed by the new structure has a total width of approximately 400 ft. and a total depth of about 70 ft. In consequence the provision of a temporary timber structure to carry the roadway clear of the existing line would prove a comparatively costly item, probably then costing three or four thousand pounds, and after completion of the new bridge this would not be of any benefit to the community. The new bridge is arranged on the line indicated. At the southern end there was no difficulty in keeping the existing roadway open, since the new roadway commenced at a point some distance back from the bridge and at the same road level, and there were no works required immediately adjacent to the existing work. A different state of affairs existed, however, at the northern end of the bridge. At this point the new roadway was approximately 12 ft. above the existing roadway into which it ultimately joined at the same level between 200 and 300 yards away. The arrangement in this case was to complete as much as possible of the new work before making the junction between the new and the old work. Immediately this stage was reached a temporary retaining wall in rubble of sufficient strength to uphold the bank, and decreasing in height from 12 ft. to nothing, was constructed along the centre line of the existing road leaving one-half of the existing road open for single-line traffic. On completion of the filling to new road level behind this temporary retaining wall, the bottoming was placed and rolled in order to make it sufficiently solid and suitable to take a single line of traffic across the new bridge. At this stage the traffic was diverted across the new structure and then the second half of the existing roadway closed at the junction of the two bridges, the new retaining wall completed, the filling to the remaining width placed in position, and the roadbed laid as before. The traffic was then diverted to this second portion and the road surface finished on the first half of the approach road. During this time the traffic was consolidating the filling of the second half in the same way as on the first half. On completion of the road surfacing on the first half traffic was again diverted to it. The second half was then completed and the whole width of the new roadway thrown into service. This arrangement entailed only the construction of a temporary retaining wall in addition to the permanent work. This retaining wall cost approximately £300 compared with £3,000 to £4,000 for a temporary bridge, the only alternative.

It is quite impossible to deal here with every case of this nature which may occur, and the engineer must judge each on its own merits and devise the best arrangement to meet each case. He will find there are no fixed rules, but that it calls for the exercise of ingenuity and forethought. Whilst mainly concerned with the making of the preliminary survey, the engineer must keep this requirement in mind and obtain sufficient information and particulars on the site to

permit him to arrive at the best solution in the office during the preparation of his plans. In no case should arrangements for keeping the existing road open be left for the contractor to fix at a later date. The engineer and the client are the parties most competent to settle this matter, and it should be shown on the drawings and described in the specification and schedule so that contractors tendering may price the work entailed on a uniform basis.

Whilst obtaining the initial information the engineer should ascertain what sum, if any, in excess of the absolute minimum cost his clients are agreeable for him to spend on architectural treatment and finish. An ordinary plain concrete surface is seldom as pleasing as stone, but if a little additional money is expended it is possible to produce an exceedingly pleasing structure such as is presented by the elevations of many modern bridges in concrete. By suitably proportioning arch rings, spandrel walls, parapets, pilasters, and panels, and by a little judicious decoration, the result may be still further improved. This, however, may entail some additional cost, and it is important that the client should be given an idea of what will be a reasonable amount to expend and roughly what he can expect to obtain from this expenditure. This is a point best cleared up by personal discussion and interchange of views between the client and the engineer. As a general rule the client will be guided by the engineer's advice, and the reasonable amount to be expended on this item obviously depends on the æsthetic necessities of the site in question. It is best that the engineer should have the point settled in the course of his survey and site investigations, since it may materially affect his design.

#### **Available Materials and Labour.**

Next for consideration are the materials and facilities for construction. Whilst these are primarily a matter for the contractor, it is a good plan for the engineer to ascertain sources of supply of suitable stone, sand, cement, labour, water, and power. If there are only a few local sources it is advisable to visit them and verify that the materials available are really suitable for his work. If, for example, there is a stone quarry close at hand producing chippings which are not suitable for the work, it is important that this fact should be indicated to contractors tendering, for, if not, it is almost certain that due to its probable cheapness some will include for stone from this source. There are districts where there is no local supply of sand, and in some such cases there are supplies available of whin or granite dust. Whilst the actual grit from these stones may be suitable as a substitute for sand, it frequently contains so much dust or flour tending to weaken the concrete that it is not looked on favourably by engineers. Cases such as these may call for special mention in the specification, and it may be desirable not only to indicate what will not be permitted for use in the work, but also to suggest sources of supply which will be approved. It is, of course, advisable if any source of supply is mentioned that more than one be included so that the contractors may have alternative sources and be enabled to obtain competitive prices. Cement is now sold in such a way that every part of the country is covered by an agent or agents who are able to give prices for the delivery of cement either to the nearest railway station or on the site of the work.

With regard to labour, if the proposed bridge is a scheme to be assisted by a Government department there may be certain labour clauses necessary to meet

the requirements of the department making the grant. It may be necessary for labour to be obtained from prescribed areas, and to engage the whole of the labour for the work from the local labour exchange; in some cases these requirements may be qualified by a certain percentage only of such labour being necessary. In other cases there may be no restriction, and the contractor may be left free to engage what labour he requires without reference to the authorities. All these factors are of importance to the contractor and should be ascertained by the engineer and covered fully and clearly in his specification to avoid duplication of enquiries and to ensure a uniform basis of tendering.

The water supply also calls for attention. If the bridge is in a neighbourhood supplied by a water main, the engineer should enquire during his preliminary investigations regarding the amount of water available and the charges which will be made for it. Reference to the water engineer or manager for the neighbourhood will usually provide full information on this point. Usual values of charging are by meter, by a percentage (often  $1\frac{1}{2}$  per cent.) on the total value of the concrete in the work, or in some cases a special lump sum charge is arranged for the contract. The engineer should include this in his specification so that all contractors may cover this item on the same basis without reference individually to the water engineer. If there is no local main supply and if the bridge is to be over a river or stream, the engineer should ascertain whether the water in the stream or river is suitable for concrete. If the stream is free from trade waste it is highly probable that the water is satisfactory. As a general rule if it is suitable for drinking purposes it is not likely to have any seriously detrimental effect if used in concrete. On the other hand, if sewage or trade waste is discharged into the stream above the work it is possible the effluent may be detrimental to the concrete. In such cases it is desirable for the engineer to submit a sample of the water taken from the vicinity of such effluent to an analyst for report. It is also advisable to take samples of the stone, sand, cement, and water proposed for use in the work and have briquettes and blocks made and tested to verify that the resulting concrete is entirely satisfactory. If the engineer decides that this water is suitable for use he should state so in his specification, and should later specify and include in his schedule for obtaining water from the stream or river for use on the work, as this may entail some expenditure in providing storage tanks, pumps, or other plant.

Another case occurs when the bridge is some distance from any source of water supply. In such cases the engineer should ascertain where there is suitable water and enquire whether he will be able to use this water in the work. Here again he should obtain full particulars, and it is advisable that he should write his specification in such a way that contractors will visit the source of supply and verify for themselves how they can best obtain the water and transport it to the site.

Finally, there is the question of power. It is now possible to obtain plant for concrete works driven by steam, electricity, or petrol motor. As a general rule electricity is the most convenient. If it is available a short distance away it may be an advantage to have the power led on to the site and used there for various purposes, subject to the work being of sufficient magnitude. If there is a possibility of this, the engineer should obtain full particulars from the competent authority and should later include them in his specification and schedule.



The contractor should be allowed some freedom because insistence on a particular type of power may entail uneconomical conversion of plant.

### Summary.

(1) A journey along the road for a mile or two on both sides of the bridge to obtain a general impression of the countryside and of the type of structure best suited to it.

(2) Study of Ordnance Map showing the site.

(3) Permission from adjoining proprietors to make a detailed survey.

(4) A survey of the site of the bridge and of a length of road at each end, and of any side roads in order to plan not only the bridge but its approaches in the most balanced and satisfactory manner.

(5) Photographs to be obtained of the site and surroundings.

(6) The nature of the ground on which the structure is to be built should be ascertained by means of bores, trial pits, or particulars of existing foundations. If safe load tests are ultimately required they may often be deferred to a more convenient time and a conservative assessment made at this stage.

(7) Information regarding any coal workings existing or proposed under the site or approaches of the bridge, and for a distance of, say, one mile radius, together with the depths and thicknesses of the seams being worked.

(8) The services which it is necessary to accommodate over the bridge, such as drainage, water, gas, electricity, telephones, telegraph, etc.

(9) Particulars of the highest known flood, together with levels and speed with which such floods rise and any other information likely to be of use in the design or to the contractors in tendering for the work.

(10) If the river is tidal, records of a neap and a spring tide should be obtained sufficient to provide tide charts for the guidance of the contractor.

(11) Particulars should be obtained of the streams or drains into which it may be possible to drain the ground water from abutments and approaches and also the surface water from the new bridge deck.

(12) Notes should be made of any special works, such as accommodation roads, mill streams, tow-paths, footways, etc., crossing the line of the new structure or affected by the scheme.

(13) The necessity or otherwise of keeping open existing roads which may be affected by the construction of the new bridge should be ascertained, and consideration given to the methods to adopt to achieve this economically and effectively.

(14) The sum, if any, available for beautifying the elevation of the new structure should be ascertained.

(15) The sources of supply of suitable stone, sand, cement, labour, water, power, together with what in the case of water and power will be the charges made by the competent authorities for their use in the course of the construction of the new bridge, should be investigated.

(16) Particulars of local authorities, Government departments, catchment boards, land drainage and navigation authorities, railway, canal, or other authorities affected by the scheme.

## CHAPTER III

### BRIDGE TYPES AND CHOICE OF TYPE

TYPES AVAILABLE—FOUNDATIONS— FOUNDATIONS LIABLE TO DISTURBANCE  
— LENGTH — LOADS — WIDTH — CONTOUR — APPEARANCE — TYPICAL  
EXAMPLES—SKEW SPANS

#### **Bridge Types Available.**

EVERY site provides its own particular conditions affecting the choice of the type of bridge most suited to the situation. The number of different cases is so great that it is impossible to do more than sketch the general principles involved and to give some brief indication of the procedure the engineer should adopt in selecting the type of bridge for any particular site. There are roughly thirteen main types of bridge construction in reinforced concrete, most of which are again subject to variation in transverse arrangement in two or more of five different ways. In considering what type of bridge is best suited to any particular site therefore the engineer has a very wide choice before him, and the selection of the type best suited to the site conditions will call for careful consideration of every item of data he may be able to collect.

For most sites it will be found that several of the different types of construction will meet the local conditions, and the selection of these is not difficult. They may in fact be chosen by inspection of the types illustrated later, with little more than consideration on the lines of the accompanying notes. To choose from these the particular type which will meet the conditions with maximum efficiency, permanency, and economy is a much more complicated matter, and it will probably call for rough calculations and rough estimates to assist in the comparison of two or more of the possible schemes before the correct choice can be made. Whilst it is necessary to make investigation for each individual case encountered in practice, some assistance can be obtained by a consideration of the various factors which affect the choice, and it is the object of this chapter to define these factors and to suggest the general lines of investigation which may be followed.

The following notes relate to the thirteen different types of bridges referred to, and which are illustrated in *Figs. 22 to 34* with the various transverse arrangements "A" to "E" shown in *Figs. 35 to 39*. Against each of the diagrams is given the approximate smallest span for which each type would be usually considered and the span range over which each type is commonly applied. Examples of girder and arch bridges of various types are given in Appendix V. It may be expected that the development of reinforced concrete, more particularly in regard to the use of higher working stresses, will in future tend to increase the maximum span for each type.

Type No. 1 (*Fig. 22*) is a freely-supported slab or girder construction resting on abutments of any suitable form or material. This type is generally suited to spans up to say 35 ft. for a slab or a slab and beam construction, and to approximately 70 ft. if some form of parapet girder is used. It is simple to design and construct, and provided the bearings are properly arranged it offers a certain degree of "flexibility" in the event of bedding down or other disturbance of the substructure.

Type No. 2 (*Fig. 23*) consists of a series of continuous spans each of which may have a length up to say 70 ft. if parapet girders are used, but which would probably be limited to about 50 ft. in the case of girders below the slab and to 30 ft. if solid slab construction were adopted. In this type stresses set up by contraction and due to temperature changes must be taken into account. These may necessitate a cross division of the bridge by expansion joints at intervals if the total length is considerable. Care will also be required in the design of the bearings on the piers and abutments to avoid any considerable lateral stresses being transmitted to the piers.

Type No. 3 (*Fig. 24*) is a rigid frame construction in which the horizontal deck slab is made monolithic with the vertical abutment walls. This construction is suited to spans up to say 50 ft. but would not generally be found economical for spans exceeding about 30 ft. For larger spans, it would be of beam and slab construction.

Type No. 4 (*Fig. 25*) is a series of continuous spans in which the superstructure is not only continuous in itself but is also monolithic with the supporting abutments and piers. The span limits are similar to those of Type No. 3. This is a form of construction which should not be adopted where there is any doubt of the rigidity of the foundation, for it will be apparent that any bedding down of the piers or abutments relative to the other foundations would induce extremely high stresses. For ideal situations, as for example on rock foundations, the method would be economical.

Type No. 5 (*Fig. 26*) consists of continuous girder spans having varying moments of inertia along the span. As shown, this gives to the soffit of each span a shape similar to an arch, but where the girders are designed to project above the deck the structure may resemble a cantilever girder or a suspension bridge in outline. This is a type of construction suited to much longer spans than those previously mentioned, and it might be used with advantage in favourable circumstances up to a span of 150 ft. or even more. The superstructure might be made continuous with the piers and abutments or might be provided with free supports on the top of the piers and abutments. Generally speaking there is an advantage in providing joints, so avoiding somewhat doubtful variations of stress in the substructure and foundations.

Type No. 6 (*Fig. 27*) is suitable where the bridge is divided into several spans. Its main feature is the construction of alternate spans with projecting cantilevers the ends of which are used as supports for freely-supported spans constructed between them. This construction has been used for spans up to 200 ft. It has evidently greater "flexibility" than any of the continuous spans already mentioned and is therefore particularly well suited to sites liable to some bedding down or settlement of the supporting piers. For short spans up to say 40 ft. plain bearings may be used between the piers and the superstructure,

but for longer spans a form of rocker or roller bearing which will permit of slight rotation due to loading, bedding down of the foundations, or other causes is an advantage.

Type No. 7 (*Fig. 28*) consists of a single long span between supporting piers, but with projecting cantilevers on the landward side of the piers at both ends forming counter-balances the effect of which is to reduce the positive moment in the central span. This construction has been used for spans of up to 450 ft. If of three spans, the design can be varied by the introduction of joints and a freely-supported span in the middle of the central span. This gives the construction greater "flexibility." It is a type open to considerable development and is being adopted with advantage in more cases than has been done in the past. Where the span is across a canal or river and towpaths are required on both sides the cantilevers projecting behind the main piers can be arranged to span over these paths.

Type No. 8 (*Fig. 29*) is a fixed arch, or arch made monolithic with the abutments or piers, and provided with closed spandrels, i.e. with side walls built up along both sides of the arch, the space between and over the arch barrel being filled with soil or other suitable material up to roadway level. It is suitable for use on spans up to 200 ft., or in special cases even more, but it is not often adopted for spans exceeding 120 to 150 ft. The reason for this is that the use of solid filling greatly increases the dead weight of the structure over and above that required if a construction similar to Type No. 9 is adopted.

Type No. 9 (*Fig. 30*) is a fixed arch in which the arch barrel or ribs are monolithic with the supporting abutments or piers. Instead of the solid filling noted in Type No. 8 the deck is carried by column, beam and slab construction, or cross-wall and slab construction. This type has been used successfully for the longest spans constructed in reinforced concrete, notably the Elorn bridge at Brest, the Esla viaduct in Spain, and the 866-ft. span Sandö bridge in Sweden.

Type No. 10 (*Fig. 31*) shows a three-hinged arch in reinforced concrete. It has been adopted with success for spans exceeding 300 ft. and is suitable for situations where there is a possibility of slight movement in the foundation, as may possibly occur in certain types of soil or in areas subject to mining or other disturbance. Another advantage is the reduction of stresses due to contraction and temperature changes which become so important in monolithic structures. The hinges may be made entirely of metal, may be moulded in concrete, or may be formed in the reinforcement of the bridge.

Type No. 11 (*Fig. 32*) shows a two-hinged arch. This is a type which is not frequently adopted. It has an advantage over the fixed arch in some cases, but as a general rule it will be found that if hinges are to be introduced then it is better to use three hinges, one at each springing and one at the crown, rather than to limit them to one at each springing as in this type. Here again the use of the hinges appreciably reduces the stresses due to contraction and changes of temperature.

Type No. 12 (*Fig. 33*) is the bowstring form of construction consisting of arch ribs constructed above the deck level of the bridge with horizontal ties connecting the springings and resisting the horizontal thrust of the arches. These ties are therefore in direct tension. Usually they are suspended from the arch

rib at intervals and form the side members of the deck construction. This form can be adapted to long spans, one of the longest built being 300 ft. By some engineers the direct tension in hangers and horizontal ties is considered to be an objectionable feature tending to the development of hair cracks in the concrete which might result in deterioration of the reinforcement ; there is little direct evidence to support this criticism, however.

Type No. 13 (*Fig. 34*) is a variation of the bowstring construction in which the deck is placed at a level above the apparent springing of the arch. The deck is suspended by ties from the arch rib for the major portion of its length, but towards the end is supported from the top of the arch ring by means of columns or cross walls. This is a type which the site conditions seldom make necessary.

Most of the thirteen types described are subject also to variation in the arrangement of the cross section of the bridge. These are indicated in *Figs. 35* to *39* and are marked Types A, B, C, D, and E.

Type A (*Fig. 35*) consists simply of a slab of uniform thickness throughout the cross section. It is found in short-span portal-frame construction and in some parapet-girder bridges.

Type B (*Fig. 36*) consists of a deck slab supported by ribs or beams on the underside, and is possibly the most common form of deck slab construction in bridge work.

Type C (*Fig. 37*) consists of a deck slab supported by ribs or girders projecting above it along both sides. Its usual form is that of the parapet bridge.

Type D (*Fig. 38*) is similar to Type C except that the upstanding ribs are not so deep and do not form part of the parapet. It is not a very common form of cross section.

Type E (*Fig. 39*) is a cross section of a cellular type of bridge in which a soffit slab is provided along the bottom of the girders and the deck slab spans across the girders at the road level. Externally a bridge of this type has a solid appearance. Due to the reduction of dead weight which results it is a form suited to long spans, and is used with either girder or arch construction.

Types A, B, D and E can be used for any width of bridge, whilst Type C is suitable only for comparatively narrow bridges usually of the parapet girder type.

In addition to these general types and variations in reinforced concrete bridge construction one occasionally encounters what may appear to be unusual types, often simulating structural steel work in general arrangement and appearance. Actually these may almost invariably be included with one or other of the types illustrated. The great amount of intricate shuttering work which they involve makes them unsuitable for what are to-day considered normal spans. Due, however, to the saving of dead weight resulting from their open-work construction they appear to be more suited to very long span bridges, and it is mainly in this class of work that they have been used up to the present. For spans under 250 to 300 ft. it is doubtful whether they would prove economical.

Having before us the different types of bridge which may be adopted, there

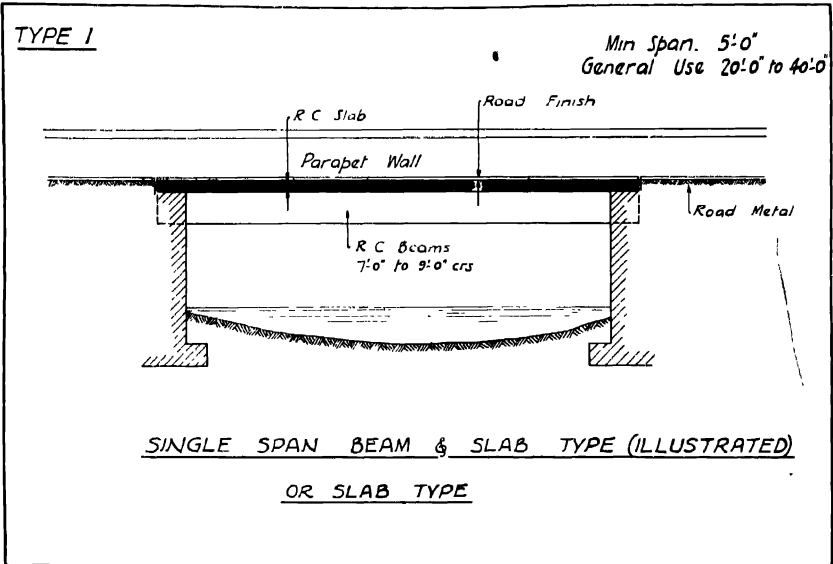

Fig. 22.

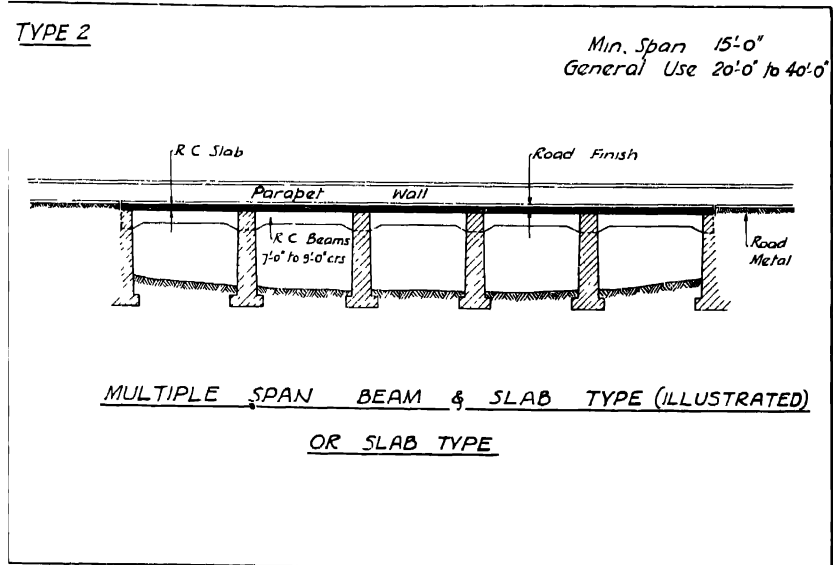
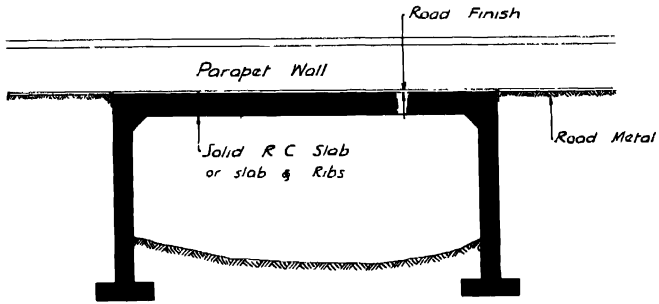

Fig. 23.

TYPE 3

Min. Span 5'-0"  
General Use 15'-0" to 30'-0"



SINGLE SPAN PORTAL FRAME TYPE

SLAB TYPE (AS ILLUSTRATED) OR SLAB & BEAM TYPE

Fig. 24.

TYPE 4

Min Span 15'-0"  
General Use 20'-0" to 40'-0"

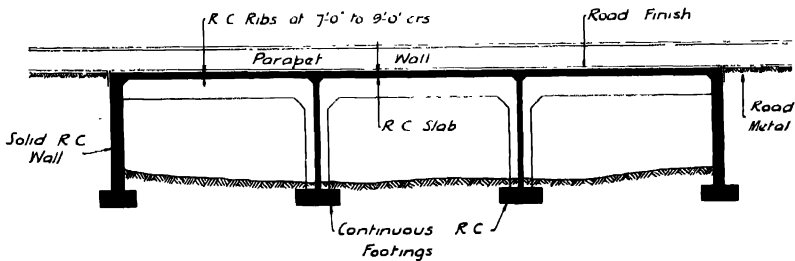

MULTIPLE SPAN PORTAL FRAME TYPE

SLAB & RIB TYPE (AS ILLUSTRATED) OR SLAB TYPE

Fig. 25.

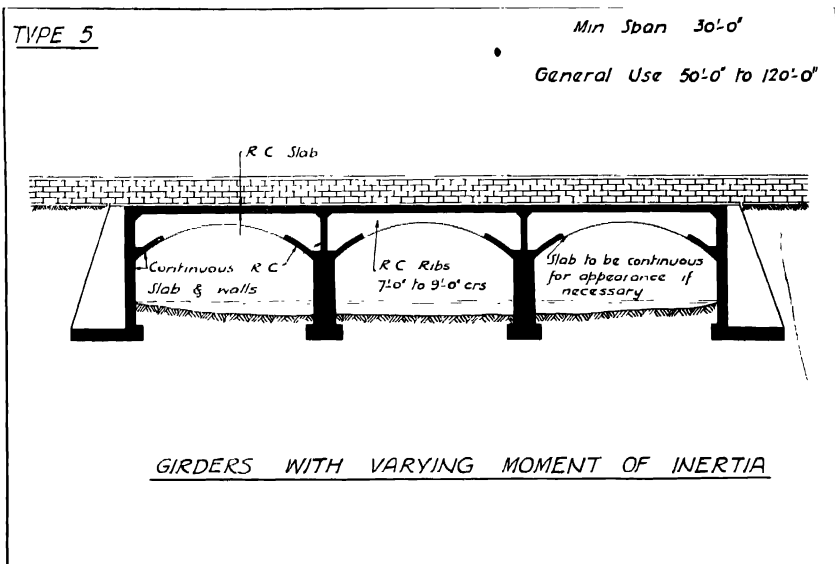

Fig. 26.

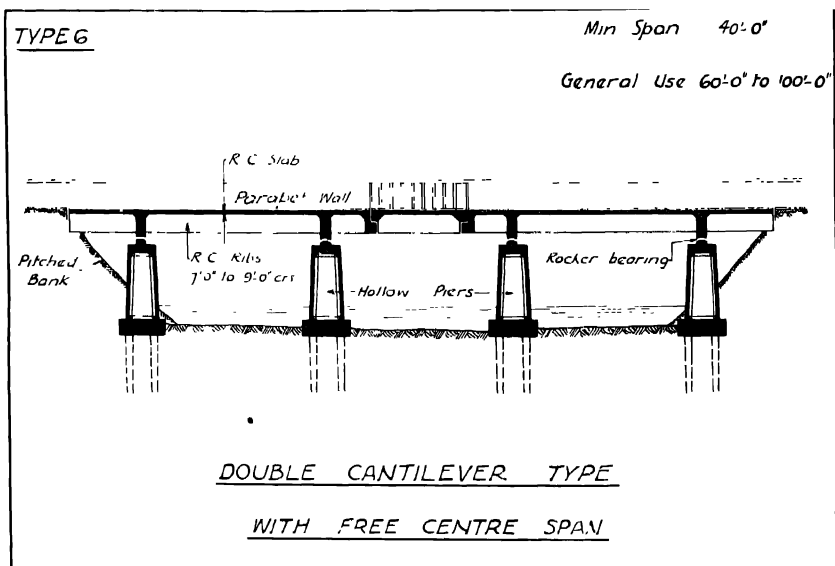

Fig. 27.



TYPE 7

Min. Span 40'-0"

General Use 60'-0" to 120'-0"

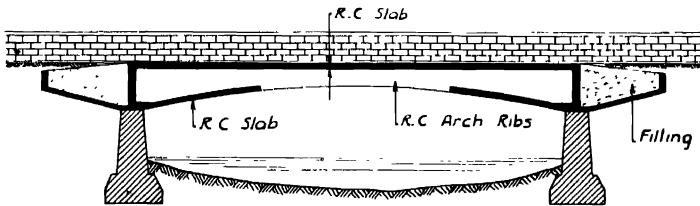

DOUBLE CANTILEVER TYPE

Note. In longest spans Bottom Boom is at Deck level & girders project above

Fig. 28.

TYPE 8

Min Span 10'-0"  
General Use 30'-0" to 100'-0"

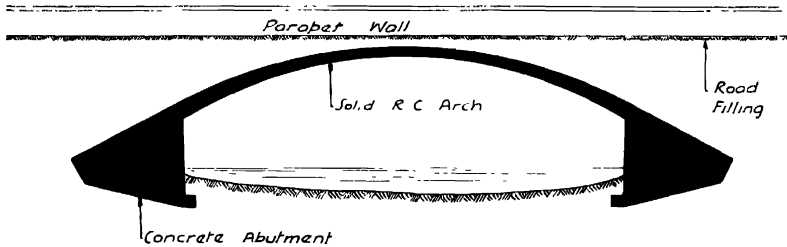

FIXED BARREL ARCH TYPE

MAY BE SINGLE OR MULTIPLE SPAN

Fig. 29.

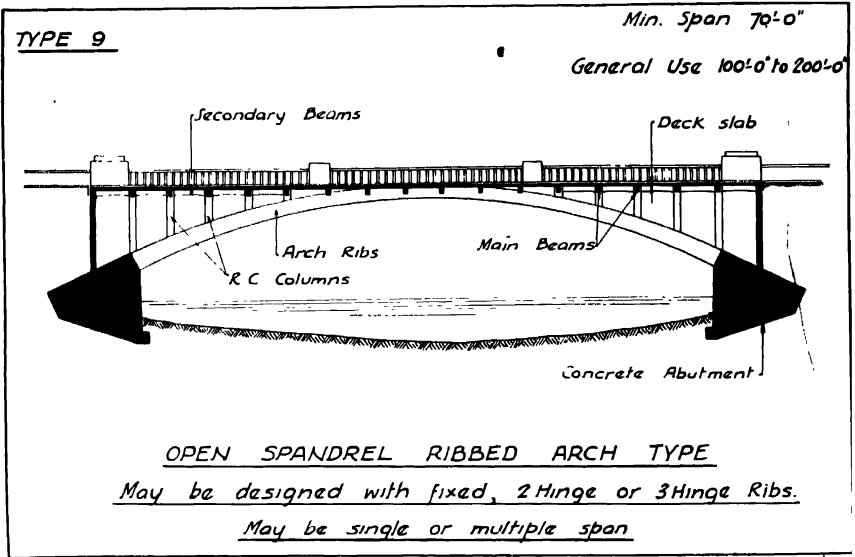

Fig. 30.

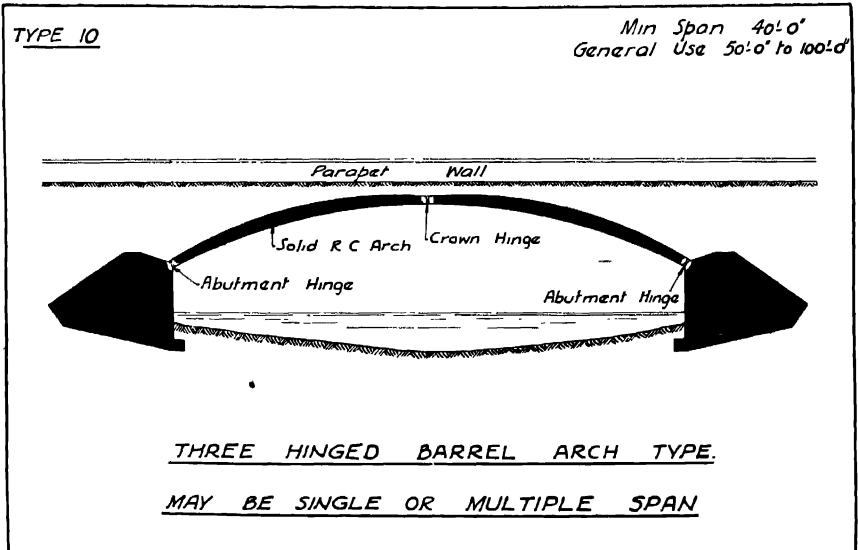
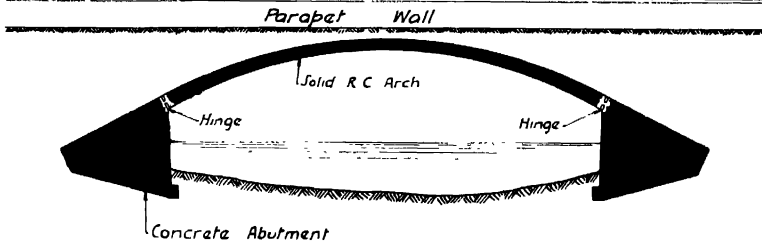

Fig. 31.

TYPE 11

Min. Span 40'-0"  
General Use 50'-0" to 100'-0"



TWO HINGED BARREL ARCH TYPE

MAY BE SINGLE OR MULTIPLE SPAN.

Fig. 32.

TYPE 12

Min Span 70'-0"  
General Use 100'-0" to 150'-0"

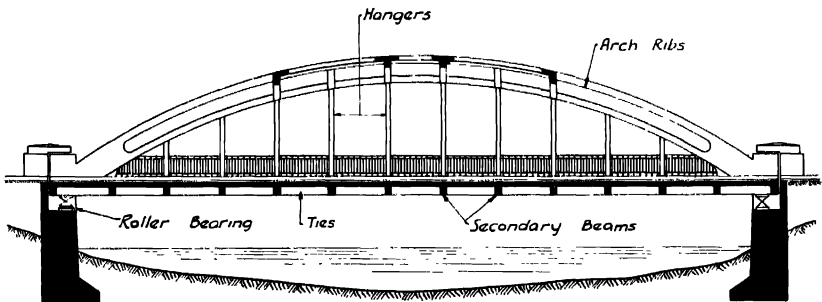

BOWSTRING GIRDER TYPE

MAY ALSO HAVE HINGE AT CROWN

Fig. 33.

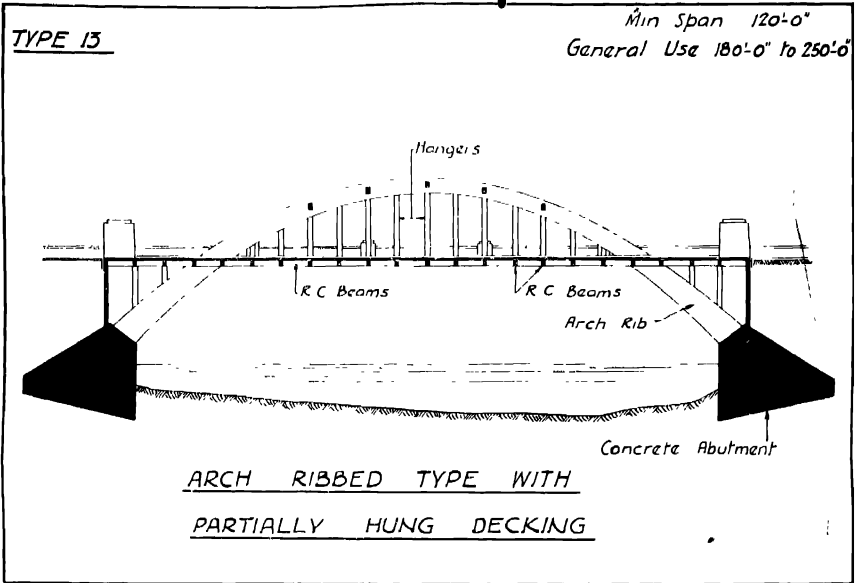

Fig. 34.

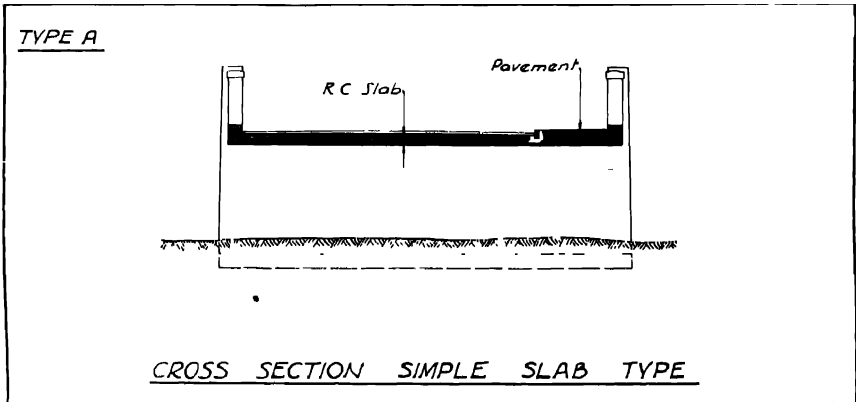
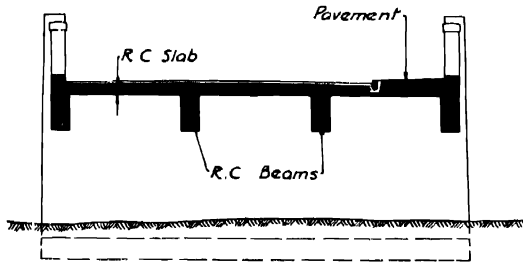

Fig. 35.

TYPE B



CROSS SECTION BEAM & SLAB TYPE

Fig. 36.

TYPE C

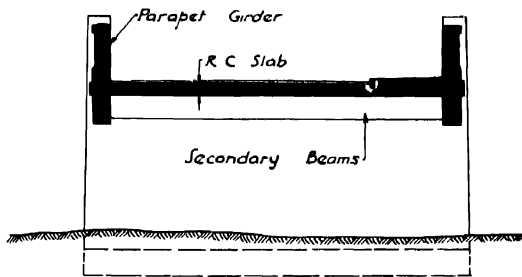

CROSS SECTION PARAPET GIRDER TYPE

Fig. 37.

TYPE D

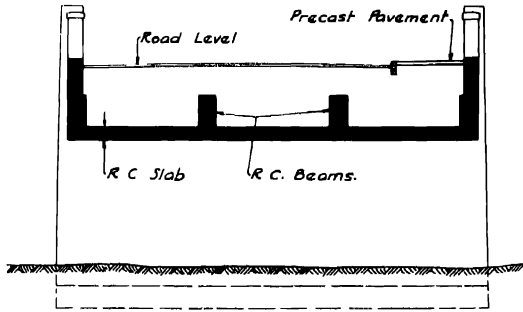

CROSS SECTION UPSTANDING BEAM & SLAB TYPE

Fig. 33.

TYPE E.

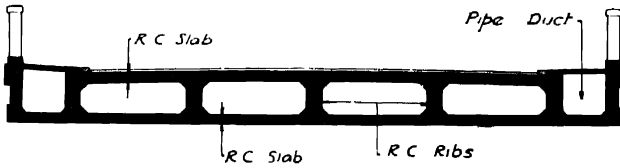

CROSS SECTION CELLULAR TYPE

Fig. 39.

are three questions to which answers must be found before one can decide on the type of bridge most suited to any particular case.

- (1) Which of the types can<sup>a</sup> be adapted to the particular site in question ?
- (2) Which of these possible types will do the work most economically ?
- (3) Are there any disadvantages in the adoption of this most economical scheme ? If so, one must then consider one of the schemes which is a little more costly than the cheapest to meet the requirements.

If we can find definite answers to these questions for any particular example then we shall be in a position to concentrate on the detail design of the chosen type knowing that the final design will have all the requirements of the ideal bridge and particularly those of efficiency, permanency, and economy.

In endeavouring to find an answer to these three questions, there are two sets of factors which call for consideration. The first, which may be termed the natural factors or factors dependent entirely on the site conditions, are

- (a) The foundation.
- (b) The possibility of mining or other disturbance.
- (c) Headroom necessary.
- (d) The length of the bridge.

There is also a number of what may be termed artificial factors, that is, factors decided by the necessities of the case. These may be enumerated as

- (a) The load which the bridge is to carry
- (b) The width of the bridge.
- (c) The contour.
- (d) The appearance.

Let us now consider these factors separately with a view to appreciating the extent and manner in which they affect the choice of bridge type.

### Foundation.

It may be taken as a general rule that if the foundation work is comparatively costly it will be better to reduce the number of foundations as much as possible and in consequence to use comparatively long spans. If, on the other hand, the foundations are likely to be inexpensive it will be more economical to use short spans and a comparatively large number of foundations.

It has often been suggested that in multiple-span bridges the division of spans should be such that the total cost of the substructure equals the cost of the superstructure. Whilst there is some justification for this it should not be followed too rigidly in view of the many factors involved in the choice of type of bridge. These statements are, however, open to some qualification. Take for example the case where the ground is particularly poor and where in consequence it is necessary to spread the load from the new bridge over the whole area of ground covered by the bridge. This might conceivably occur on a site where it is impossible to obtain an absolutely rigid foundation at any reasonable depth which could be reached by piling, but where a comparatively low loading of the ground at shallow levels is permissible. Although the foundations in such a case would be comparatively expensive, it would obviously be an advantage to have several short spans rather than one long one in order to reduce the stresses induced in the raft system connecting the various piers and abutments.

From the general rule one is also led to the fact that, in most cases, if the foundations require to be carried to comparatively deep levels they will be costly and in consequence it will be better to use comparatively long spans and so reduce the number of foundations. At the same time it should be noted that if a foundation is obtainable only at a very low level it will be better to have only vertical loading, and in consequence for single spans the arch type of construction is not likely to be favoured in cases of this kind. For multiple-span bridges, however, where the major portion of the horizontal thrust would be balanced over intermediate piers, the objection would not apply so strongly. On the other hand, if the foundations are shallow they are likely to be comparatively cheap and short spans will be favoured. Such shallow foundations will also be more suited to deal with inclined forces, and an arch type of construction would therefore offer some advantage. Where abutments or intermediate piers are to be constructed in a river or other water, dams are likely to be required. These are temporary works carried out solely for the purpose of facilitating the construction of the permanent structure and are removed after the permanent structure is completed. It is therefore desirable to limit the expenditure on such temporary works as much as possible, and this can best be done by reducing the number of foundations required. This automatically guides one to a reduction in the number of spans, so that in such a case, other factors being equal, comparatively long spans are favoured.

The reason for the total cost increasing considerably with the increase in the number of dams is apparent, for as a general rule the longer side of the dam will be across the bridge and the short side in the direction of the span of the bridge. For example, suppose a bridge pier is 50 ft. long, say a little more than the total width of the bridge, and has a width of say 12 ft. ; if two such piers are required the total length of dam required will be 248 ft. If, however, four piers are used the width of pier to give the same intensity of loading on the ground will be in the neighbourhood of 6 ft. and the total length of dam required for four piers would be 448 ft., or almost twice as much as in the first case. In addition to the fact that the length of the dam increases almost directly as the number of supporting piers and abutments, the delay occasioned in constructing a number of such dams, timbering inside, pumping out, withdrawal of the dams after use, etc., is likely to be considerable and to increase appreciably the cost of the finished work.

*Table II* gives the approximate weight per square foot which the superstructures of bridges of various spans are likely to produce, and if to these are added the design load per square foot calculated as equivalent to the live load, one can rapidly find approximately the total load on the foundations for any given span. From the information obtained during the investigation at the site the reasonable intensity of loading to be imposed on the ground at different levels will be known, and by equating the two one will be able to find roughly the width of foundation required for any subdivision of length. If the total width of the foundation for the chosen span does not exceed 20 per cent. to 25 per cent. of the span then it will usually be reasonable to spread the load from the pier. If, however, the spread required exceeds 25 per cent. of the span it is probable that it may be economical to go deeper with the foundations to a stiffer stratum or to use piles, or to deal with them in an even more elaborate



TABLE II.

## APPROXIMATE WEIGHTS PER SQUARE FOOT OF GIRDER OR OPEN SPANDREL ARCH BRIDGES.

| Span in ft. | Approx. dead load of bridge superstructure per square foot lb. | Ministry of Transport approximate equivalent live load per square foot * lb. |
|-------------|--|--|
| 20          | 160  | 355  |
| 30          | 180  | 310  |
| 50          | 215  | 274  |
| 70          | 250  | 259  |
| 100         | 310  | 235  |
| 150         | 400  | 210  |
| 200         | 490  | 194  |

[Note : Add the dead and live load figures given to the approximate weight of the foundations per square foot of bridge. This total multiplied by half the bridge area equals the load on one foundation for a single-span bridge.]

\* Includes knife-edge load

## EXAMPLE.

The use of the above table may best be shown by an example.

Suppose one is considering the adoption of a 100-ft. span girder bridge. The approximate width of foundations required may be determined as follows :

|   |            |               |
|---|------------|---------------|
|   | lb.        |               |
| Dead load   | = 310      | } from Table. |
| Live ,,   | = 235      |               |
| Foundations, say $\frac{2}{3}$ weight of superstructure | = 200      |               |
|   | <u>745</u> |               |

Safe intensity of pressure from foundations = 2 tons per square foot

$$\therefore \text{width of one foundation} = \frac{50 \text{ ft.} \times 745}{2 \times 2240} = 8.3 \text{ feet.}$$

In the case of an arch bridge, the values of the live load and the weight of the superstructure could be taken from this Table, and the approximate horizontal thrust obtained from the formulæ  $H = \frac{Wl^2}{8r}$ , where  $r$  is the rise of the arch. The size and shape of the foundations are then best determined graphically, being largely dependent on the height of the arch springing from the natural foundation level.

way. Having made rough calculations on this basis, the engineer will find it necessary to prepare rough comparative costs of foundations necessitated by different spans or types to guide him to an answer to the question "What type and span of bridge is to be adopted?"

#### **Foundations Liable to Disturbance.**

In mining areas or in areas where brine is pumped from the ground there is considerable possibility of settlement taking place in the ground at great depths below the bridge foundations. It should first be appreciated that such movements are really miniature earthquakes, and it is quite impossible to prevent this type of disturbance from affecting the bridge structure no matter of what material or to what design it may be built. No amount of spread or increase in the depth of the foundations (short of carrying the foundations down to a depth below the mine workings) will prevent ultimate settlement taking place where the whole of the ground sinks for great depths. In consequence it is necessary for the engineer to keep in mind that the bridge may settle and that it may not settle uniformly. In such cases he should adopt a type which will allow for considerable relative variations in settlement, of say 6 in. or more, of the abutments and various piers, dependent on the knowledge of the settlement already experienced in the neighbourhood, and the design must be such that this settlement may take place without affecting the strength or permanency of the structure. A factor of this kind will have a considerable effect on the choice of type of bridge to be built, and will always lead away from monolithic construction towards one of the "flexible" types having the maximum number of hinged joints.

In this connection it should be noted also that in such cases there is a slight possibility of greater settlement at one end of an individual pier or abutment than at the other. In other words, it does not necessarily follow that a pier will settle uniformly over its whole area; it may in fact tilt across the bridge. The only way of providing for this contingency is to design and construct the pier as stiffly as possible along its length so that it will be capable of standing stresses induced by such unequal settlement, and by increasing the intensity of load on the part of the foundation which does not settle will tend to crush this and to keep itself as nearly as possible on an even keel. Reinforced concrete is particularly well suited to the construction in such cases. In steel bridges arrangements are sometimes made for the jacking up of the girders on the top of the abutments and piers in the event of non-uniform settlement. There is no reason why a similar arrangement should not be adopted in reinforced concrete construction. The dead weight is generally greater, but usually it would not be found either difficult or unduly expensive to provide facilities for jacking up the reinforced concrete superstructure. Unfortunately there has been up to the present a tendency to decry the use of reinforced concrete for cases of this kind, but it is anticipated that in future there will be a slowly increasing adoption of reinforced concrete for bridges of this type. In such cases Types Nos. 6, 10, and 12 are suitable for consideration; the remaining types should not be adopted.

Another very important factor in deciding the type of bridge to be used is

the maximum construction depth available. The level of the soffit of a bridge is usually governed either by the height of flood water or by any navigational use to which the river or stream may be placed. On the upper side the level will be governed by the contour of the roadway over the bridge, and the difference between the two will give the construction depth available. If this construction depth is large then it will in itself have no effect on the type of bridge to be used, but if it is restricted and it becomes less than a twentieth part of the span then the girder type of construction (Nos. 1, 2, 3, and 4, and possibly also No. 6) is not likely to be suited to the case. Instead it will be found that Type No. 12, the bowstring girder, requires the minimum constructional depth owing to the fact that the actual carrying members of the bridge project well above the roadway. Types Nos. 5, 7, 11, and 13 will probably be the next most suited for a case of this kind. As regards the cross section of the bridge, Type A would probably give the minimum of constructional depth, followed closely by Types C and D. The construction depths necessary for a roadway say 20 ft. in width, using Type No. 12 bowstring girder, will probably be from 18 in. to 24 in. and will be quite independent of the bridge span and wholly dependent on the width between the bowstrings and also on the load to be carried. The arch construction (Types Nos. 8, 9, and 11) and the girders having varying moments of inertia (Type No. 5) will probably necessitate a constructional depth in the centre from a thirtieth or a fortieth part of the total span of the bridge, depending to some degree on the constructional depth available at the springing or alternatively on the rise of the arch.

### Length of Bridge.

The total length of the bridge is another factor affecting the type to be adopted, and the length itself depends almost entirely on the economic point at which the change should be made from suspended to solid construction. It resolves itself into a comparison of costs of suspended approaches and of solid approaches consisting of approach walls and the necessary filling. A table similar to *Table III* based on rates applicable to the site will be of assistance. This gives the approximate cost of retaining walls of various heights on normal ground together with the cost of filling per foot of length for varying heights and for approaches having a total width of 20, 30 and 40 ft. The cost of the filling is based on a rate of 10s. 6d. per cubic yard in place. If we take the cost of construction of suspended approaches at say £30 per square yard and compare this with the cost of the solid approach construction we can quickly find a suitable point at which to change from solid to suspended work. As a general rule this will be found to occur where the bank in the approach increases beyond 20 ft. in height. It should be noted that prices and rates will vary for different districts as the prices of the various materials involved vary from time to time, and that unusual conditions may increase unit costs. In consequence it will be necessary for the engineer when he has an important bridge structure under consideration to make up approximate prices based on the local rates ruling at the time on the same lines as those shown for purposes of comparison.

There are numerous factors which may considerably influence this decision. For example, in some cases the materials excavated may be gravel suitable for

use in concrete, and even if not suitable for reinforced concrete it may be reasonably suitable for mass concrete. In a case of this kind the retaining walls to the approaches would be more economical to construct than in normal cases, and in consequence it would probably be an advantage to carry out the solid approach work farther and higher than in a normal case.

A similar effect would result if filling were particularly cheap or if it was necessary to find a suitable tip for the excavations for the bridge foundations. Here it would be advisable to arrange the approach works so that they would absorb the whole of the surplus excavation available.

Another case might occur where it was wished to make some improvement to a corner of the roadway at a site not far distant from that of the bridge and where there might not be available a suitable tip for any surplus soil. In such a case use might be made of the approaches of the new bridge to deposit the soil from such an improvement.

The type of foundation will also have to be taken into account. In cases where suspended work necessitates deep and costly foundations, while solid construction can be founded cheaply at shallow levels, then the latter will obviously offer an advantage and will in consequence be adopted as far as possible.

It will also be noted from consideration of *Table III* that the narrower the bridge the longer will be the total span, from solely economical reasons due to the fact that the approach work will always call for two supporting walls which are much more expensive than the intervening filling and more closely approach the unit cost of suspended work. Usually, therefore, the narrower the bridge the longer the suspended work and the shorter the solid approach; the wider the bridge, the shorter the suspended work and the longer the solid approach work.

A further factor which might have some effect on the position at which one changes from solid to suspended work is the cost of the land on which the bridge is to be built. If this was particularly high it would be desirable to limit the width taken up by the banking of the approaches as much as possible and in consequence this banking would probably be retained between walls for the whole of its length.

These various factors affecting the point where the change should be made from solid to suspended work have been briefly mentioned, but their number might be considerably extended; in fact the data collected at the site of any proposed bridge will almost invariably contain some novel factor affecting this choice. Those mentioned will, however, provide some guidance to the line of thought necessary when considering this matter.

In addition to consideration of the points at which the change from suspended to solid work should be made, one must also consider the question, "When should one change from main spans to suspended approach spans?" This is a factor almost invariably settled by the contour of the site, but in principle it should be noted that down to comparatively short spans the greater the number of supports the lower the cost of the suspended work per unit of area on normal foundations.

Another factor which will enter into the question is that of the width of the river to be spanned, and as has already been noted it is essential that the

TABLE III.

APPROXIMATE COSTS OF SOLID CONSTRUCTION FOR BRIDGE APPROACHES.

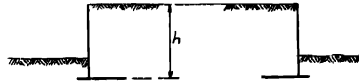

| Height<br>in ft. | Cost per lin. ft. |          | Cost per lin. ft. of filling at<br>10s. 6d. per cub. yd. |                          |                          | Notes.   |   |
|------------------|-------------------|----------|--|--------------------------|--------------------------|--|---|
|                  | 1 wall            | 2 walls  | Bridge<br>20 ft<br>wide                                  | Bridge<br>30 ft.<br>wide | Bridge<br>40 ft.<br>wide |  |   |
| 8                | £4 0s             | £8       | £3 2s.   | £4 13s.                  | £6 4s.                   | (i) Add cost of 2 walls and filling between, and where this is less per square yard than the cost of suspended work, or say approximately £30, then solid construction is probably preferable. |   |
| 10               | £6 0s             | £12      | £3 18s   | £5 17s                   | £7 16s.                  |  |   |
| 12               | £8 5s             | £16 10s. | £4 13s. 6d.  | £7                       | £9 7s.                   |  |   |
| 15               | £13 0s.           | £26      | £5 17s   | £8 15s. 6d               | £11 14s                  |  |   |
| 18               | £18 10s           | £37      | £7   | £10 10s.                 | £14                      |  |   |
| 20               | £23 0s            | £46      | £7 16s   | £11 14s.                 | £15 12s.                 |  | (ii) If basic costs vary from those used in the preparation of the Table, the tabulated values should be amended proportionally before use. |
| 25               | £37 0s.           | £74      | £9 14s 6d  | £14 12s                  | £19 9s.                  |  |   |
| 30               | £55 0s.           | £110     | £11 13s. 6d  | £17 10s                  | £23 7s                   |  |   |
| 35               | £77 10s.          | £155     | £13 12s  | £20 7s 6d                | £27 3s                   |  |   |

## EXAMPLE.

A bridge approach is to be 30 ft. wide and 30 ft. above foundation level. Will solid or suspended construction be more economical?

From the Table :

Cost of two walls = £110 os.

„ filling = 17 10s.

£127 10s.

$$\begin{aligned} \text{Cost of solid construction per square yard} &= \frac{£127 \text{ 10s.} \times 9}{30} \\ &= £38 \text{ approx.} \end{aligned}$$

Suspended construction (cost £30 per square yard approximately) would probably be the cheaper.

full area of waterway existing before a bridge is built shall be preserved in the design of the new structure.

### **Loads, Width and Contour.**

Next we come to artificial factors affecting the choice of type. In the first place we have the question of load. Where this is heavy it will tend towards the adoption of comparatively short spans, whilst if the design load is light it will tend towards the adoption of longer spans. The reason for this is that the heavier the load the heavier the construction required to carry these loads and the more expensive in consequence does the suspended work become.

The next question is that of width of bridge. This has not a very great influence on the type of construction to be chosen except in cases where the bridge is so small that parapet girders may be adopted. These will provide an economical form of construction, but they are not generally liked owing to the possibility of vehicles colliding with them, and in damaging the parapet at the same time damaging the supporting power of the structure. This is a factor which does not occur if the parapet is not part of the supporting structure of the bridge as is the case in every other type.

The next factor is the contour of the bridge, and this can be adapted to any type except that of the bowstring, which as a general rule is made horizontal or with only a very slight camber along the length of the bridge rising towards the centre.

### **Appearance.**

Finally there is the question of appearance. Where the bridge is to show a concrete finish any of the types may be adopted, but where it is wished to add a veneer of stone or other material then only solid spandrel construction is suitable. This can be obtained in Types Nos. 1, 2, 3, 4, 5, 6, 7, 8, 10 and 11.

A decision on the subdivision of the total length of a bridge is also frequently affected by the appearance. Unless there is special reason to the contrary, multiple-span bridges should have an odd number of spans, an even number never looks well unless there is a special reason obvious to the layman when the bridge has been constructed.

In certain situations some of the types may appear incongruous and unsuitable, and this is a factor which should be given careful thought, for it is unwise for the engineer when designing a new structure to offend the æsthetic taste of the general public. He must remember, however, that the purpose of a bridge is of greater importance than its appearance, and it is seldom that the type of bridge to be adopted will be governed by its elevation. Instead, when an architect is not employed, it will be a problem for the engineer to make the elevation of the most suitable type of bridge fit in as well as possible with its surroundings. There is a case where a bowstring girder has been erected in a wild moorland situation, and which in consequence has been severely criticised on the score of its unsuitable elevation. In this case the bridge crosses a stream traversing a wide valley, the stream being liable to sudden and high floods. To have raised the roadway in the neighbourhood of the bridge in order to permit of an arch or girder type of construction would not only have been expensive but might also have been dangerous due to the possibility of floods overflowing the

river bank and causing damage to the new embankment on both sides. In consequence a bowstring girder was adopted requiring the minimum constructional depth and so providing the maximum headroom for the flow of water. This is a perfectly sound engineering decision. It is admitted that the appearance of the bridge is not quite suited to the countryside. Possibly a roughly bush-hammered stone, concrete, or masonry-faced arch would have been more fitting, but this is a case in point where although the bowstring is unsuitable from the æsthetic point of view it is nevertheless the only sound engineering solution of the problem.

### Examples.

Having suggested in brief outline the various questions which arise in selecting a type of bridge, it is proposed to apply the conclusions to a number of typical cases where bridge construction might be required. It must be understood that every bridge type requires separate consideration of all the factors mentioned before a final decision can be arrived at, and the three examples given are merely a guide to the method of analysis and are not the analysis itself for any actual bridge.

**EXAMPLE 1.**—A deep and narrow rocky ravine, with rock outcropping at both sides and everywhere found at shallow depths below the surface soil.

This is obviously a case where it would be expensive to bring a foundation up from the bottom of the ravine to a comparatively great height and consequently at considerable cost. The case would therefore lead one toward the adoption of a single-span bridge. If the span were up to approximately 30 ft., Type No. 1 might be adopted. The rocky side of the ravine could, however, provide excellent resistance to the thrust of an arch, and in consequence Type No. 8 would also call for consideration due to the fact that there would be no likelihood of settlement in the rocky sides of the ravine. The fixed arch type No. 8 would here be preferable to the hinged types Nos. 10 or 11. As there are no practical limits to the construction depths this factor does not affect the decision. The choice would probably rest between Types Nos. 1 and 8, and a comparison of cost and appearance would finally determine which of these types would be used.

**EXAMPLE 2.**—A rocky valley, comparatively shallow and narrow, with the rock to be found everywhere at comparatively shallow depths below the surface. It is probable that in such a case the stream in the valley would be liable to considerable flooding.

In this case the foundations would evidently be inexpensive, and in consequence it would be reasonable to use comparatively short spans. There is no possibility of mining or other disturbance, and in consequence there is no necessity to make the bridge particularly "flexible." Owing to the probability of considerable flooding it would be desirable to provide the maximum waterway and also to give plenty of length to the bridge in order not to affect either the flow of the river in flood or the distribution of flood water when the river overflows its banks. In consequence, if the span does not exceed 30 ft. Type No. 1A (*Figs. 22 and 35*) would require consideration. If the span is greater, *Fig. 36* or *Fig. 37* could be used for spans up to say 70 ft., although in view of the comparatively inexpensive foundations it would probably be found more economical

to divide the total length into two or more spans. If the total width were 70 ft. or more, and if the construction depth available was very little indeed, and if a single span offered some decided advantage, then a bowstring type of construction might call for consideration. The possibilities here would probably be narrowed considerably by the detail data for any particular case, and as in Example 1 would probably resolve itself into the comparison of cost and appearance of, say, two of the types mentioned.

EXAMPLE 3.—A wide deep valley with a stream to be crossed by the bridge, the ground being of normal type.

In this case the foundations and substructure would be likely to prove expensive due to their considerable height, and in consequence it would be desirable to limit the number of spans as much as possible. Due to their height, as previously noted it would be better to produce only vertical loadings. This rules out arch construction unless the arches are made with very considerable rise and spring from a level close to the ground. No mention is made of mining or other disturbance, and in consequence this factor will not affect the choice. Due to the depth of the valley it is obvious that the question of construction depth and headroom under the bridge would not affect the decision. The total length of the bridge would in this case probably require careful consideration, as also the division of this total length into suitable spans. It is probable that Types Nos. 5 or 6 would prove most suitable for this case, probably adopting cellular construction for the piers.

### Skew Spans.

Skew spans affect the type of bridge to be adopted as they invariably create complications in the design although little if any in the actual construction. Types Nos. 1 and 2 are more suitable than Types Nos. 3 and 4 where spans of any considerable skew are under consideration. The reason is that in a skew span there is always a doubt as to the direction in which the load will span, and there is a probability that it will tend to carry across the shortest span, that is, normal to the line of the supports as shown on the accompanying *Fig. 40*. In such a case one would be left with a state of affairs not amenable to strict calculation in the corners of the bridge span. In these positions it is possible that fairly high concentration of stresses will occur on which it is impossible to place a calculated value. Type No. 5, with accurate calculation, is quite easily adaptable to skew spans. The same applies to Type No. 6 except that one is here faced with a somewhat peculiar state of affairs in regard to the hinges. These will not usually be normal to the centre line of the bridge, and in consequence their movement, due to various factors of load, contraction, temperature changes, etc., is somewhat complicated. For spans up to say 60 ft. this will not be a serious matter, but for spans of over say 100 ft. it would require careful consideration. It should be remembered that in cases of this kind, and in fact in every skew bridge, the reinforcement of the acute angle both of the support and of the suspended work should receive special consideration, and special reinforcement should be supplied to meet the stresses which it is evident are likely to develop and on which it is impossible to place any accurate calculation.

It will be appreciated that the choice of bridge type depends to some degree on experience, but even more on a careful study of the site conditions. At



first it will prove somewhat laborious to go into the various considerations and to produce rough designs and rough estimates of the various schemes considered. In time the choice of type becomes much more straightforward as one obtains guidance from the rough schemes and the final schemes adopted for earlier work. In nearly every case there is a particular type which will give the most satis-

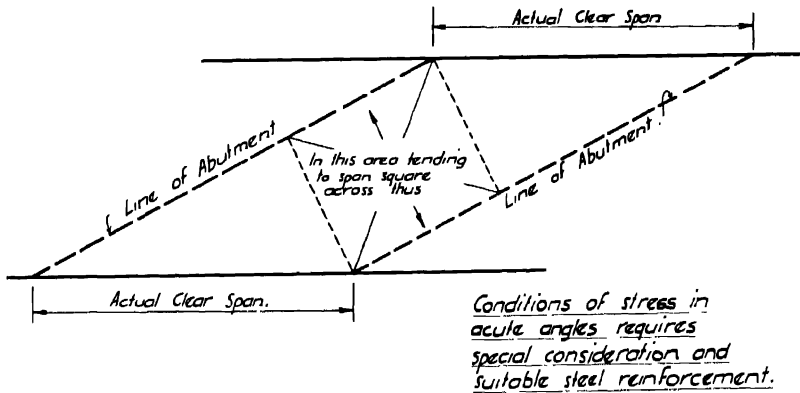

PLAN OF SKEW BRIDGE.

Fig. 40.

factory finished structure for the purpose for which it is built and which is also the most economical to meet the requirements of the case.

It should perhaps again be emphasised that the notes in this chapter provide a general indication of the line of thought required in selecting the type of bridge for any site, but that the decision for any particular case depends almost entirely on the site or on the natural and artificial conditions which have been noted.

## CHAPTER IV

### DESIGN OF SLAB AND GIRDER BRIDGES

FREELY-SUPPORTED SLAB SPANS—MINISTRY OF TRANSPORT LOADING—  
 PIGEAUD'S THEORY—SLAB CONTINUOUS OVER TWO, THREE, AND FOUR  
 SPANS—SLABS SUPPORTED ON FOUR SIDES—SINGLE-SPAN GIRDER BRIDGES  
 —LONGITUDINAL GIRDERS WITH CROSS BEAMS—GIRDERS CONTINUOUS  
 OVER TWO OR MORE SPANS—VARYING MOMENT OF INERTIA—GIRDERS  
 WITH HINGES

ONE of the difficulties in bridge engineering is the expeditious preparation of preliminary designs which will only require minor alterations to meet more exact calculations. The latter are usually checks on the final design. It is proposed here to deal with the methods of calculation of members for slab and girder bridges. The object is to give formulæ which are sufficient to prepare preliminary designs and in most cases are suitable for final designs.

#### SECTION A—SLAB BRIDGES.

##### Simple Slab Spans without Ribs, freely supported at Ends.

Slab spans without ribs and freely supported at the ends may be employed for spaces with clear openings up to 20 ft.

(a) DEAD LOADING.—The bending moment per foot width of slab is

$$M_1 = \frac{w_1 l^2}{8} \text{ ft. lb.} = 1.5 w_1 l^2 \text{ in. lb.} \quad (1)$$

where  $w_1$  = total dead loading, including road finish, in pounds per square foot and the shear force per foot width is

$$S_1 = \frac{1}{2} w_1 l \text{ lb.} \quad (2)$$

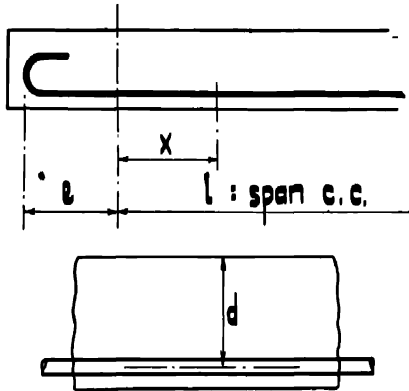

Fig. 41.



# STANDARD LOAD FOR HIGHWAY BRIDGES. EQUIVALENT LOADING CURVE.

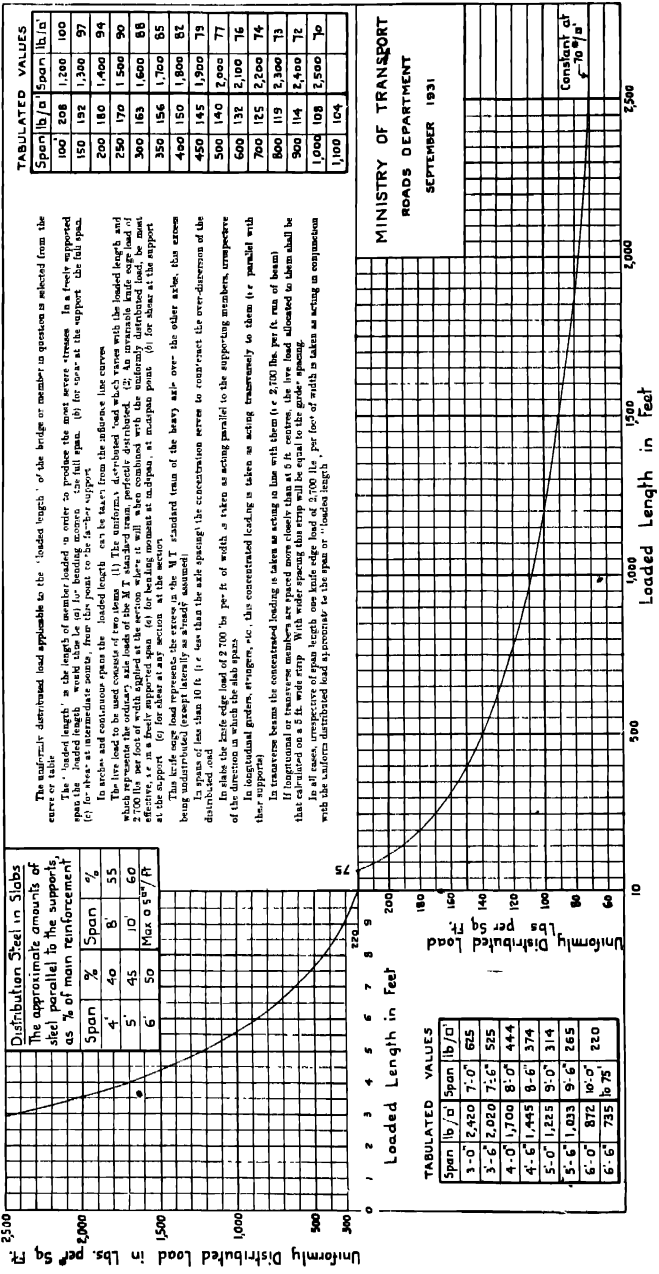

Fig. 42.—Ministry of Transport Standard Loading.

$u = u_1 + u_2 + u_3 =$  total bond stress due to live and dead loading.

Then the moments and shears due to dead plus live loads are

$$M = M_1 + M_2; \quad S = S_1 + S_2.$$

For the assumed depth of slab the moment of resistance is given by

$$\text{R.M.} = 12Rd^2 \text{ in. lb. per foot width} \quad (12)$$

and the steel area per foot width is

$$A = \frac{M}{ta_1d} \quad (13)$$

For stresses of  $c = 750$  lb. per square inch and  $t = 18,000$  lb. per square inch and a modular ratio of  $m = 15$

$$\text{R.M.} = 1510d^2 \quad (14)$$

$$A = \frac{M}{15,700d} \quad (15)$$

For other concrete stresses, in accordance with the Ministry of Transport Memorandum No. 577 (see Table VI) when  $t = 18,000$  lb. per square inch, the values are shown in Table V.

TABLE V.

| Concrete mixture | $m$   | $c$  | R.M.      | $A$                          |
|------------------|-------|------|-----------|------------------------------|
| A                | 11.11 | 1200 | $2632d^2$ | $\frac{M}{15,450d}$ . . (16) |
| B                | 12.12 | 1100 | $2412d^2$ | $\frac{M}{15,450d}$ . . (17) |
| C                | 14.04 | 950  | $2084d^2$ | $\frac{M}{15,450d}$ . . (18) |

TABLE VI.

MINISTRY OF TRANSPORT CONCRETE STRESSES

| Reference | Nominal mixture |         | Proportions   |    | Minimum cube strength for works tests. Requirements at 28 days lb. per sq. in. | Modular ratio | Permissible concrete stresses—lb per sq in |        |                  |                    | Bond |     |
|-----------|-----------------|---------|---|----|--|---------------|--|--------|------------------|--------------------|------|-----|
|           |                 |         | Cubic ft of aggregate per bag of cement weighing 112 lb |    |  |               | Bending                                    | Direct | Shear (no steel) | Shear (with steel) |      |     |
|           | Fine            | Coarse  |   |    |  |               |  |        |                  |                    |      |     |
|           | lb.             | cu. ft. | cu. ft.   |    |  |               |  |        |                  |                    |      |     |
| A         | 150             | 2       | 4   | 2  | 3  | 3600          | 11   | 1200   | 960              | 120                | 300  | 145 |
| B         | 120             | 2       | 4   | 2½ | 3  | 3300          | 12   | 1100   | 880              | 110                | 275  | 135 |
| C         | 90              | 2       | 4   | 2½ | 3½   | 2850          | 14   | 950    | 760              | 95                 | 238  | 120 |

The permissible stresses are based on the following:

$$\text{Compression due to bending} = c = \frac{\text{28-day strength}}{3} \quad (19)$$

$$\text{Direct compression} = 0.8c \quad (20)$$

$$\text{Shear stress without shear reinforcement} = 0.1c \quad (21)$$

$$\text{Shear stress with shear reinforcement} = 0.25c \quad (22)$$

$$\text{Bond stress} = 0.1c \div 25 \quad (23)$$

The shear stress on the concrete is given by

$$\frac{S}{7bd} \quad \frac{S}{10.5d} \text{ approx.} \quad (24)$$

If the allowable stresses without steel given in *Table VI* are exceeded some of the bars must be bent up diagonally or links inserted to resist the whole of the shear.

The bond stress on bars with hooked ends should not exceed the values given in *Table VI* or by formula (23). If some of the bars are bent up to resist shear, the bond stress should be calculated from the bending moment at the point where the bend nearest the support occurs; the bond on the straight length of bar extending on to the support, assumed uniform along this length, should then be estimated.

When the whole shear is resisted by reinforcement, the sectional area of the latter is calculated from the formula

$$A = \frac{S \times s}{\sqrt{2} \times 7d \times 18,000} \quad (25)$$

where *s* is the spacing of the diagonals in inches.

If either straight bars only, or a system of diagonals, be employed it will usually be found that, if the diameter of the bars is kept under 1/150 to 1/200 of the span, no trouble need be anticipated from failure of bond.

So far, in calculating the live load moments and shears, the concentrations have been regarded as equivalent to a uniformly distributed load plus a knife-edge loading placed parallel to the lines of support. Should it, however, be necessary to calculate for the actual concentrations, as may occasionally be necessary, Slater's formula, which has at least some experimental verification, is applicable. The breadth of distribution over which a concentration is taken as acting is  $w = b + kl$ , where  $w$  = breadth of concentration area,  $l$  = span of slab between its two supports,  $k$  is a constant given by *Table VII*, and  $l'$  is the breadth of slab measured parallel to the supports.

TABLE VII.

| $\frac{l'}{l}$ | $k$  | $\frac{l'}{l}$ | $k$  | $\frac{l'}{l}$ | $k$  | $\frac{l'}{l}$ | $k$  |
|----------------|------|----------------|------|----------------|------|----------------|------|
| 0.1            | 0.10 | 0.6            | 0.49 | 1.1            | 0.65 | 1.6            | 0.72 |
| 0.2            | 0.20 | 0.7            | 0.53 | 1.2            | 0.66 | 1.7            | 0.73 |
| 0.3            | 0.29 | 0.8            | 0.56 | 1.3            | 0.68 | 1.8            | 0.74 |
| 0.4            | 0.37 | 0.9            | 0.59 | 1.4            | 0.70 | 1.9            | 0.75 |
| 0.5            | 0.43 | 1.0            | 0.62 | 1.5            | 0.71 | 2.0            | 0.75 |

When the circular plane of the wheel is perpendicular to the supports

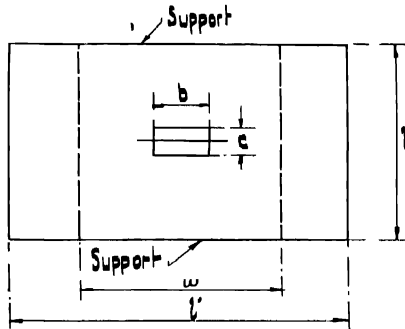

Fig. 43.

(Fig. 43),  $b$  is equal to the breadth of the wheels plus twice the thickness ( $t$ ) of the road finish.

When the circular plane is parallel to the lines of support (Fig. 44),  $b$  is the

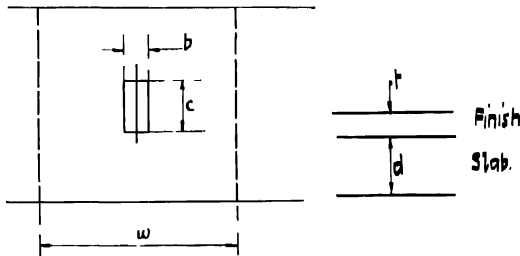

Fig. 44.

width of contact with the road finish plus twice the thickness ( $t$ ) of the road finish.

In either case, with all dimensions in feet

$$M = \frac{W}{4w} \left( l - \frac{c}{2} \right) \text{ ft.-lb. per foot of width} \quad (26)$$

where  $w = (b_0 + 2t + kl)$  or  $(3 \text{ in.} + 2t + kl)$  . . . . . (27)

and  $c = (3 \text{ in.} + 2t)$  or  $(b_0 + 2t)$  . . . . . (28)

$b_0$  being the wheel breadth and the width of contact being assumed as 3 in.

To calculate the shear the nearer edge of the load is usually assumed to be placed at a distance equal to the thickness of the slab from the edge of the support. If  $c_1$  = the width of the support (Fig. 45)

$$S = W \cdot \frac{l - d}{l} (c + c_1) \quad (29)$$

acting on a width  $w = b + k(2d + c + c_1)$  . . . . . (30)

Here  $k$  is usually assumed to be  $\frac{3}{4}$  and

$$w = b + 0.75(2d + c + c_1)$$
 . . . . . (31)

where  $b = b_0 + 2t$  or 3 in. +  $2t$  . . . . . (32)

$$c = 3 \text{ in.} + 2t \text{ or } b_0 + 2t$$
 . . . . . (33)

according to the direction of the plane of the wheel.

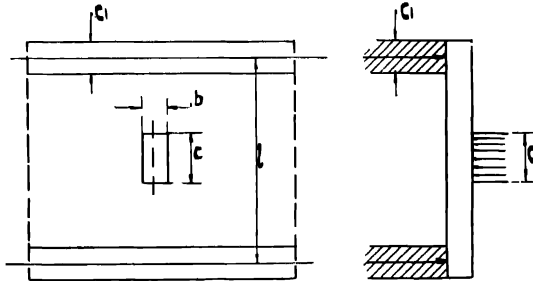

Fig. 45.

The unit shear is

$$v = \frac{S}{\frac{3}{4}dw}$$
 . . . . . (34)

In the case of two concentrations (Figs. 46 and 47) the corresponding formulæ are as follows.

CASE 1.—Circular planes of wheels perpendicular to supports (Fig. 46).

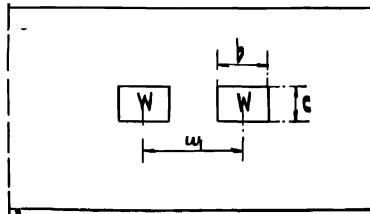

Fig. 46.

For moments, if  $b_0 =$  breadth of wheel, when  $w < w_1$

$$w = b + kl = b_0 + 2t + kl$$
 . . . . . (35)

or, if  $w > w_1$ ,

$$w = \frac{1}{2}(w_1 + b + kl)$$

$$= \frac{1}{2}(w_1 + b_0 + 2t + kl)$$
 . . . . . (36)



The moment in ft. lb. per foot band is

$$M_s = \frac{W}{4w} \left( l - \frac{c}{2} \right) \quad (37)$$

$$c = 0.25 + 2t \quad (38)$$

where

all units being in feet and pounds.

For the shear, as before,

$$S = W \frac{l - d - \frac{1}{2}(c + c_1)}{l} \quad (39)$$

$$w = \frac{b_0 + 2t + 0.75(2d + c + c_1)}{S} \quad (40)$$

$$(41)$$

CASE 2.—Circular planes of wheels parallel to supports (*Fig. 47*).

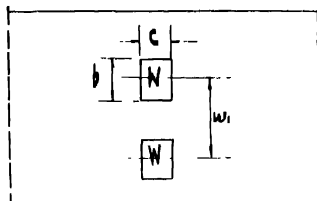

Fig. 47.

For moments

$$w = c + h(l - w_1) \quad (42)$$

where

$$c = 0.25 + 2t \quad (43)$$

the result being expressed in feet.

The moment in ft.-lb. per foot band is

$$M = \frac{W}{2w} (l - w_1) \quad (44)$$

For the shear

$$S = W \frac{l - d - \frac{1}{2}(b + c_1)}{l} \quad (45)$$

$$w = 0.25 + 2t + 0.75(2d + b + c_1) \quad (46)$$

$$S' = W \frac{l - d - \frac{1}{2}(b + c_1) - w_1}{l} \quad (47)$$

$$w' = 0.25 + 2t + 0.75(2d + b + c_1) + 2w_1 \quad (48)$$

$$S_1 = \frac{S}{w} \quad (49)$$

$$S_2 = \frac{S'}{w'} \quad (50)$$

and

$$w = \text{total unit shear} = \frac{S_1 + S_2}{10.5d} \quad (51)$$

These formulæ are based on a limited series of experiments, and to ensure the distribution longitudinal bars having a cross-sectional area of about one-third to one-half that of the main steel should be provided (see page 73).

An alternative method of calculating slabs under load concentrations has been derived by M. Pigeaud from the partial differential equations for the flexure of thin plates, the plates being regarded as of isotropic material. It is difficult to estimate the effect of the departure from this assumption in the case of reinforced concrete where two systems of reinforcement are employed at right angles to each other, one system usually being much lighter than the other. Certain authorities (for example, Mörsch, "Der Eisenbetonbau," Goodrich's translation, p. 113) regard the assumptions made, using Poisson's ratio, as inapplicable to reinforced concrete. On the other hand, the formulæ of constructional engineering generally are to be regarded merely as a shorthand notation for summarising experimental results, so as to ensure reasonable factors of safety, and it is clearly an advantage that such formulæ should have some theoretical basis. For this reason Pigeaud's results would seem to offer great advantages, once the unit stresses which may be employed in their use have been determined by experiment.

To use Pigeaud's method (Annales des Ponts et Chaussées, Mémoires 1920 --11) in the case of a single concentration, calculate

$$(1) \quad u = b_0 + 2t, \text{ or } 3 \text{ in.} + 2t \quad . \quad . \quad . \quad (52)$$

$$v = 3 \text{ in.} + 2t, \text{ or } b_0 + 2t \quad . \quad . \quad . \quad (53)$$

according to the direction of the plane of the wheel.

(2) Calculate  $\frac{u}{a}$  and  $\frac{v}{b}$  (Fig. 48) and determine  $M_1$  and  $M_2$  from Pigeaud's

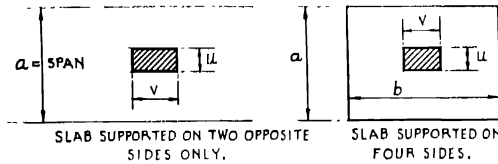

Fig. 48.

curves (Figs. 49-59). The pairs of curves (Figs. 49-56) give the values of  $M_1$  and  $M_2$ , for various values of  $\frac{u}{a}$  and  $\frac{v}{b}$  and ratios  $\rho = \frac{a}{b}$  equal to 0.9, 0.8, 0.707, 0.6, 0.5, 0.4, 0.3, and 0.2. Figs. 57 and 58 are for the case where  $\rho = 0$ . (A single curve (Fig. 59) gives the values of  $M_1$  and  $M_2$  for square slabs where  $\rho = 1$ , and a separate curve (Fig. 61) gives values of  $M_1$  or  $M_2$  in the cases where there is a uniformly distributed load over the whole slab and  $\rho$  ranges from 0 to 3. It is to be noted that  $M_1$  and  $M_2$  do not represent the actual moments, which are given by  $M$  and  $M'$  and are linear functions of  $M_1$  and  $M_2$ .) In this case use the curves  $\rho = 0$  (Fig. 57), with  $\frac{v}{a}$  instead of  $\frac{v}{b}$ .

Then  $M = \text{maximum moment across span } a = (M_1 + 0.15M_2)P \quad . \quad (54)$

$M' = \text{maximum longitudinal moment} = (0.15M_1 + M_2)P \quad . \quad (55)$

where  $P =$  the concentrated load (lb.), and  $M$  and  $M'$  are given in ft. lb. per foot width of slab. The values on the curves are  $100M_1$  and  $100M_2$ .

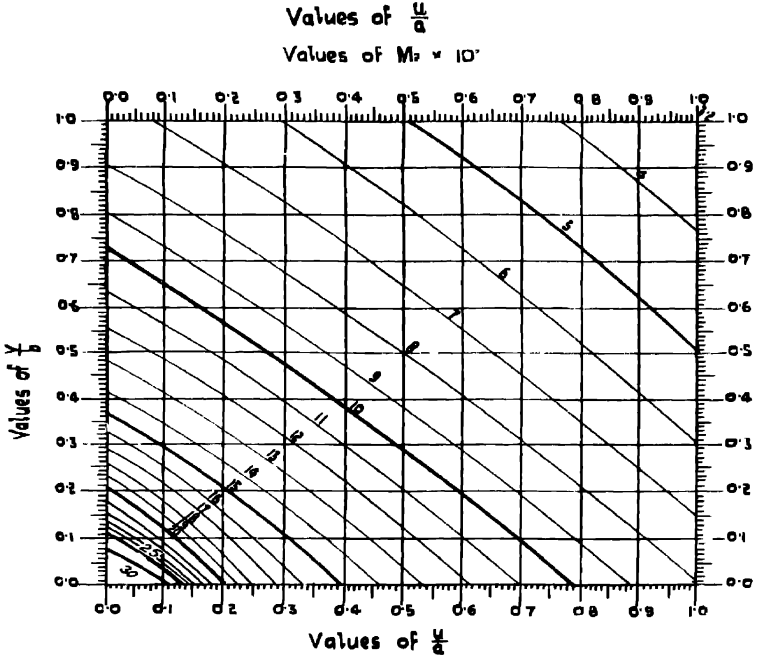
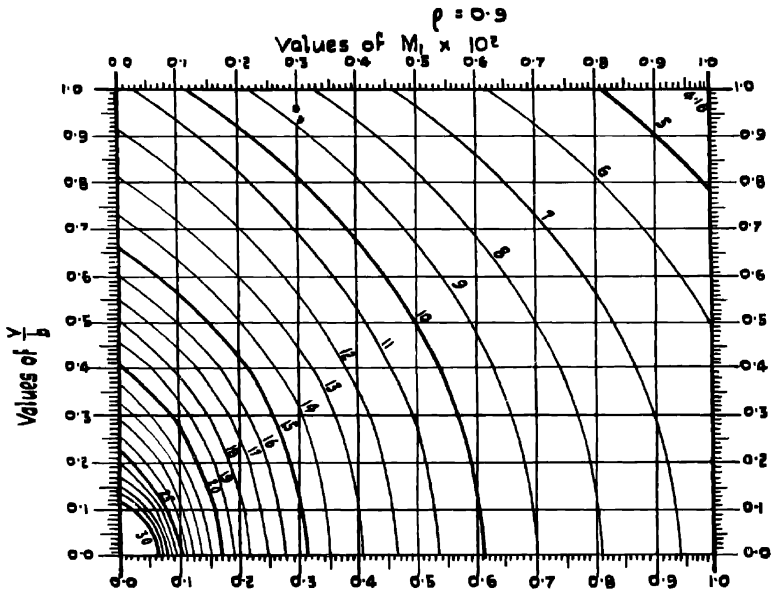

Fig. 49.  
61

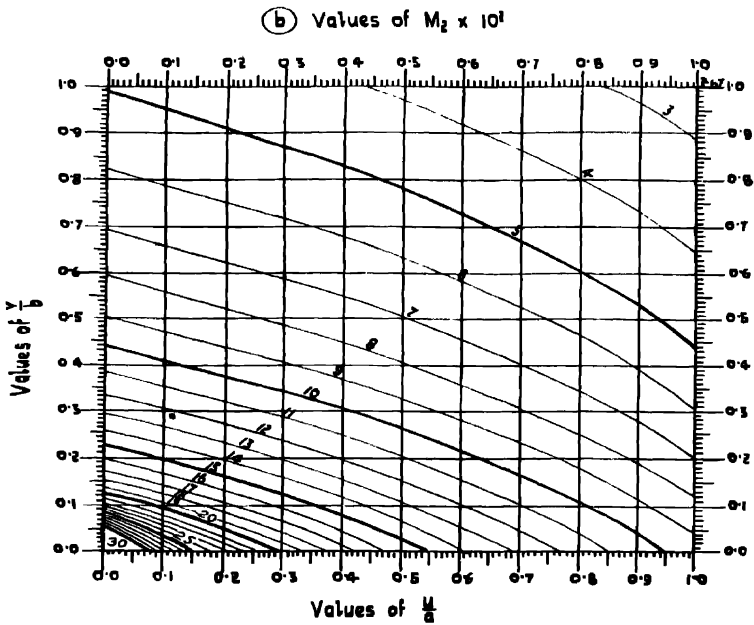
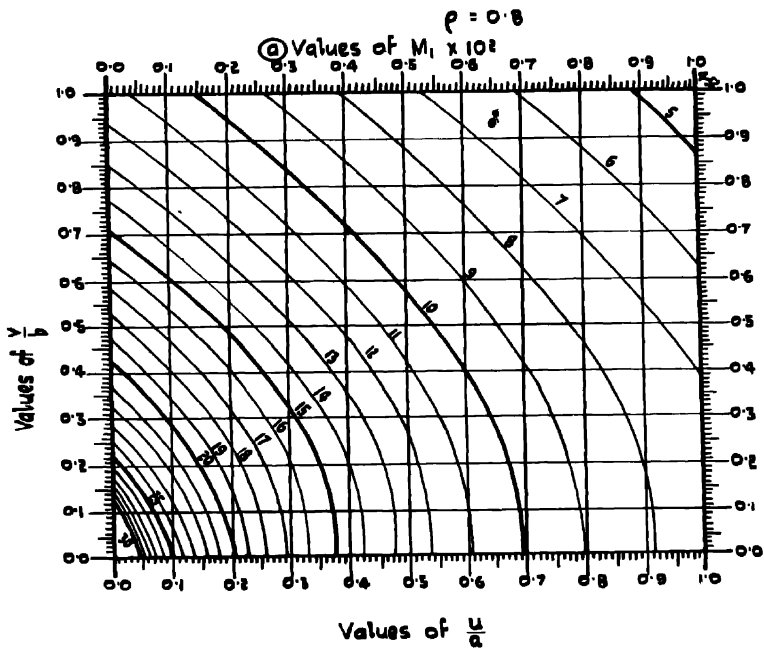

Fig. 50.

$$\rho = \sqrt{\frac{b}{a}} = 0.707$$

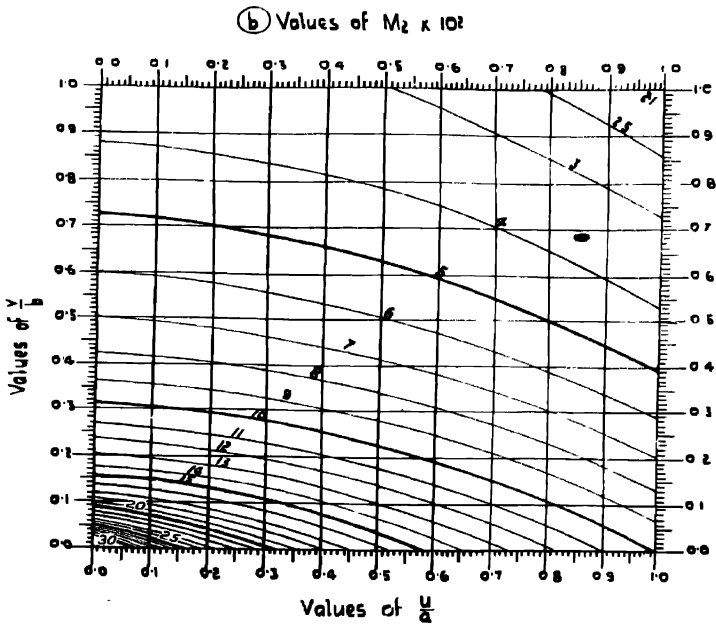
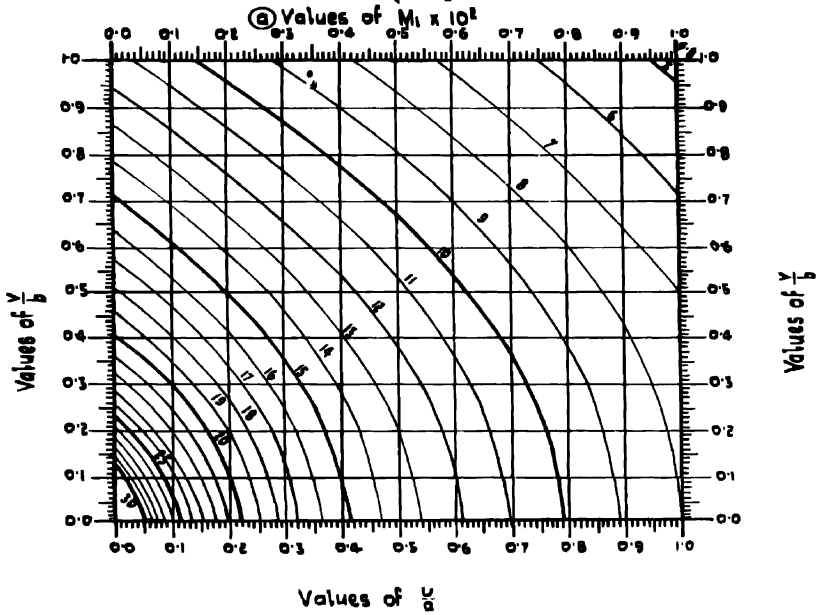

Fig. 51.

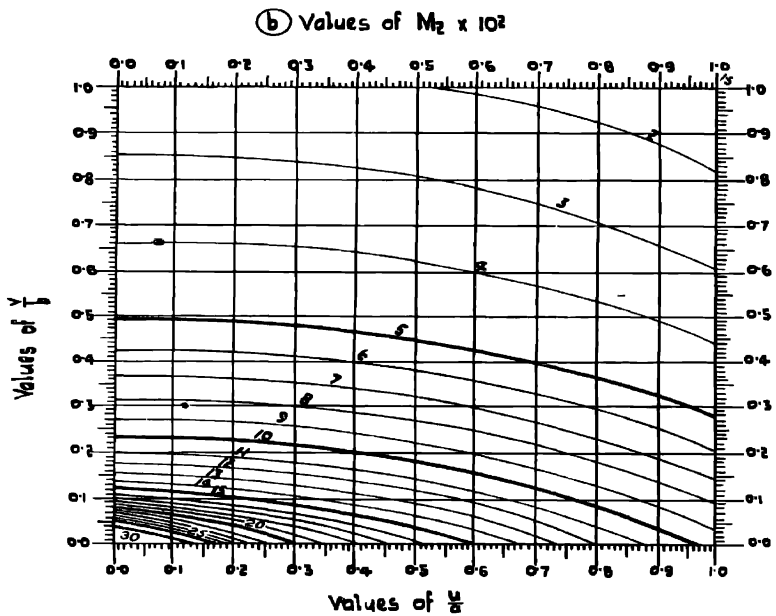
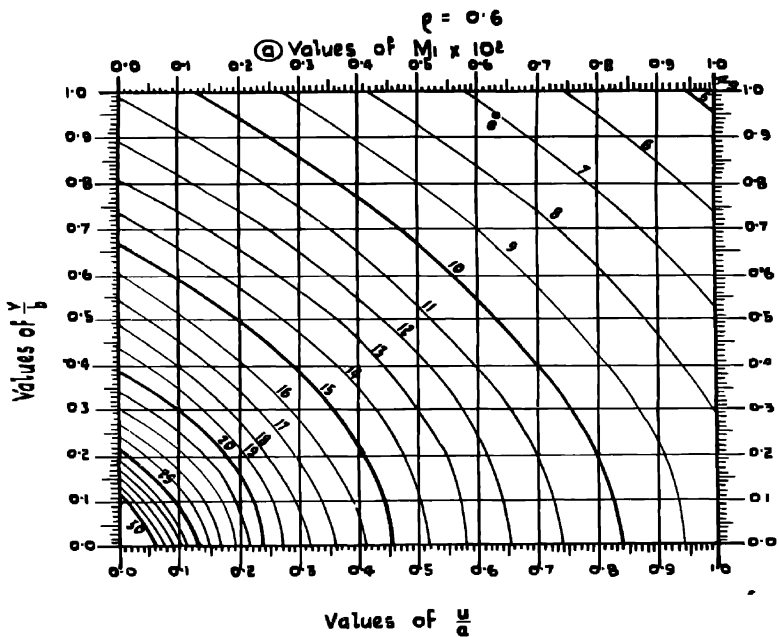

Fig. 52.

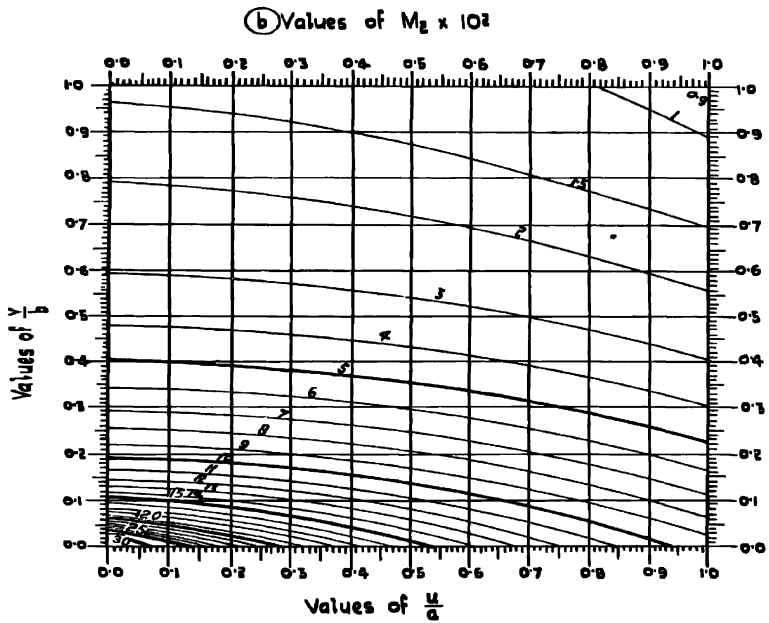
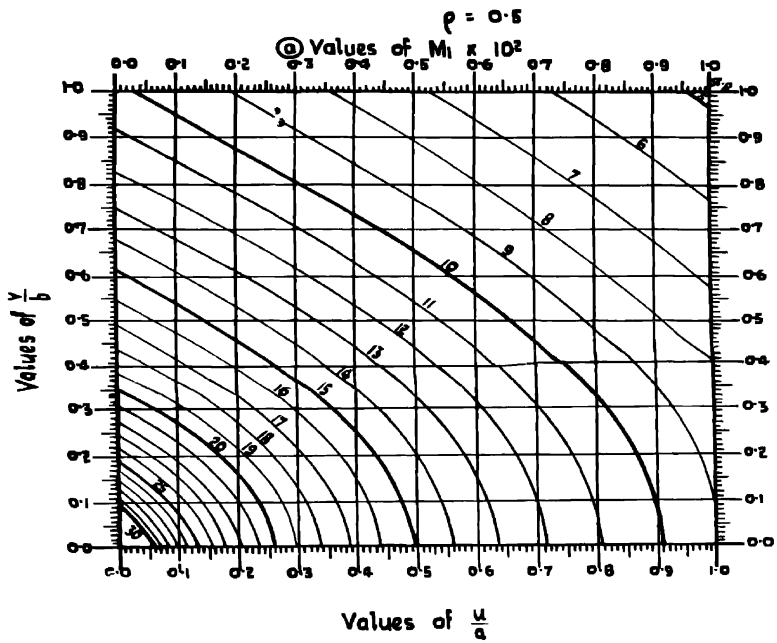

Fig. 53.

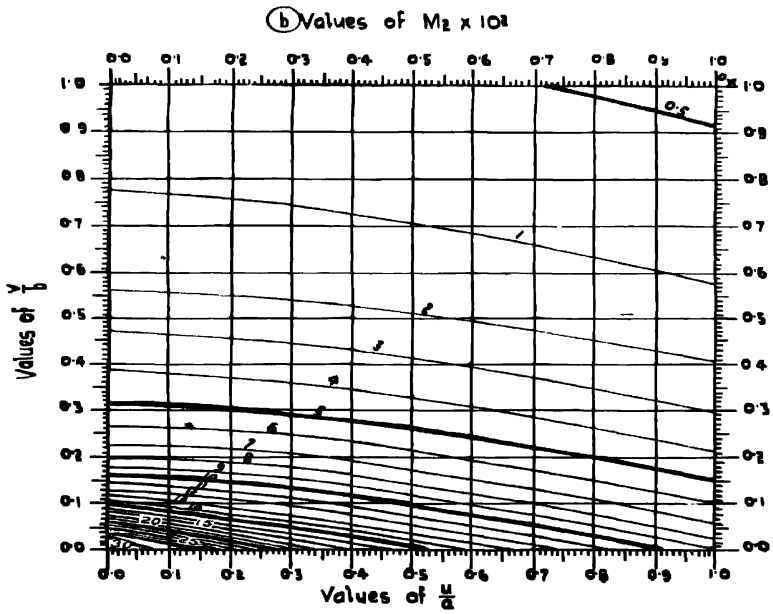
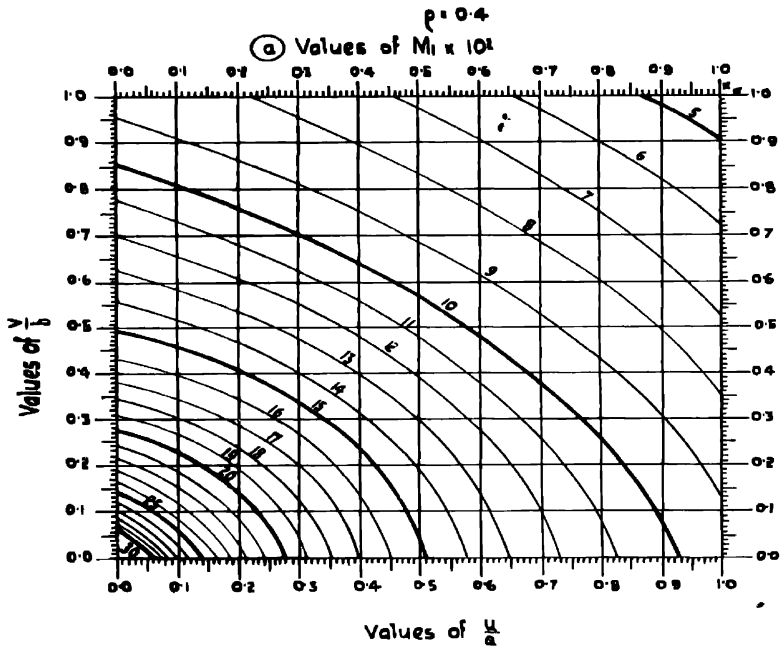

Fig. 54.



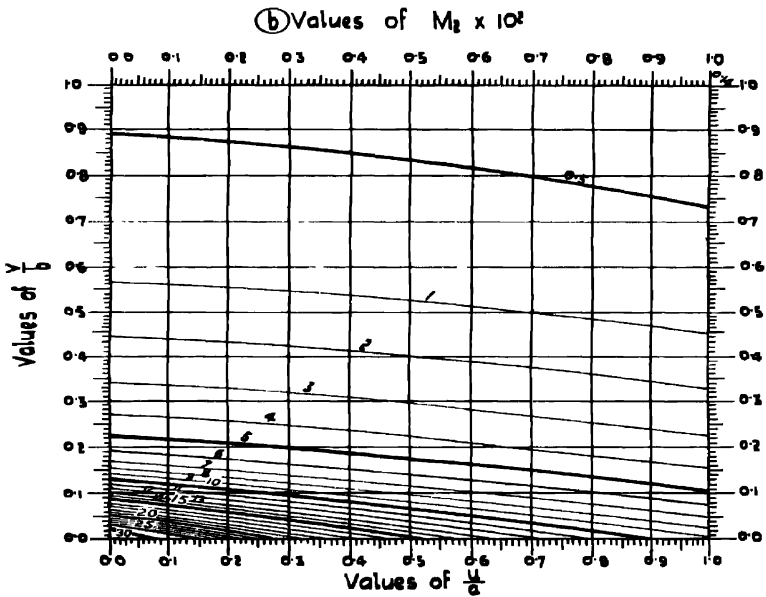
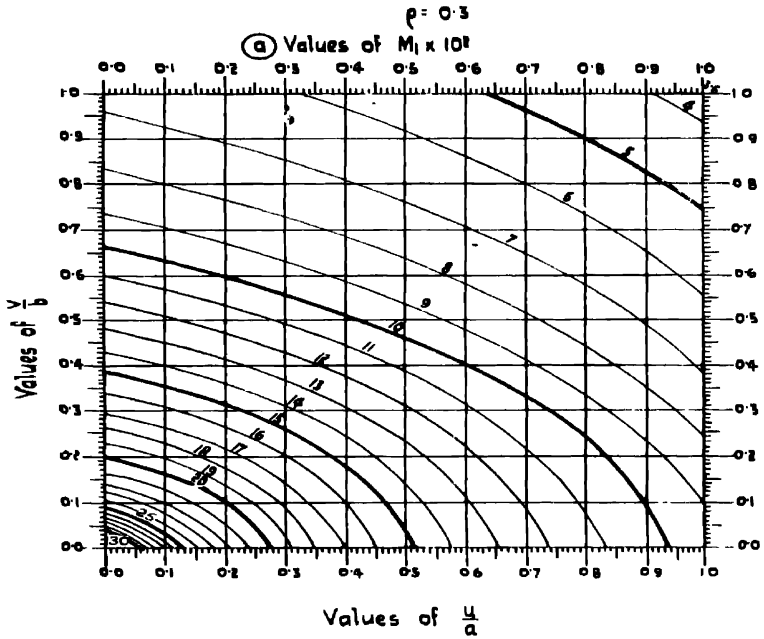

Fig. 55.

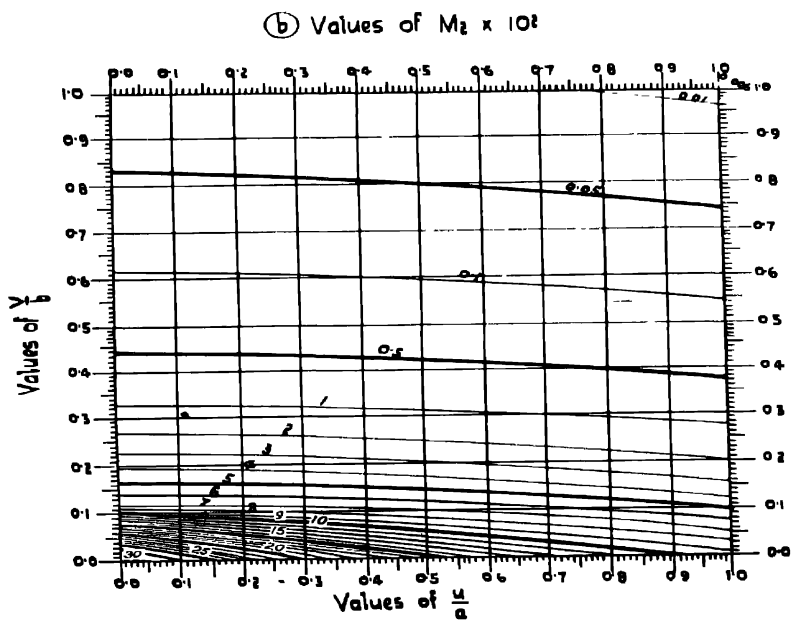
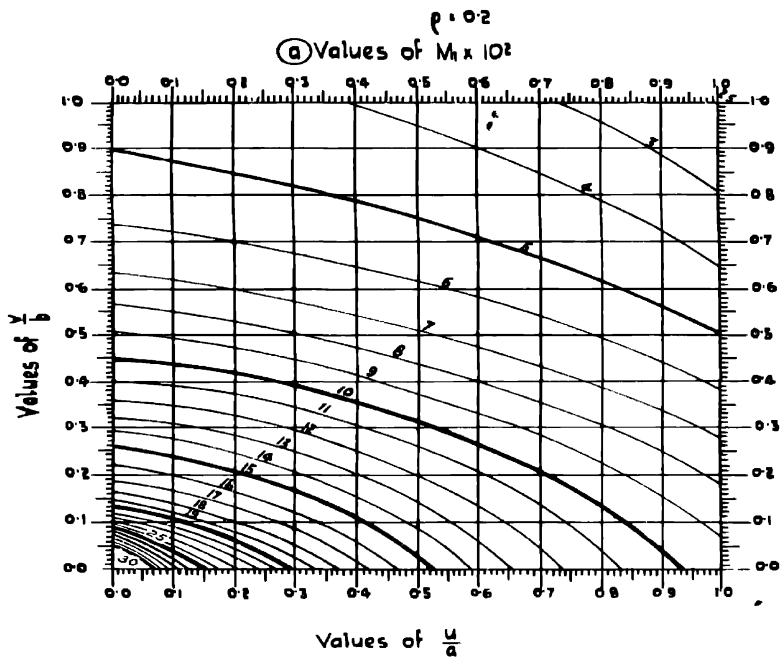

Fig. 56.

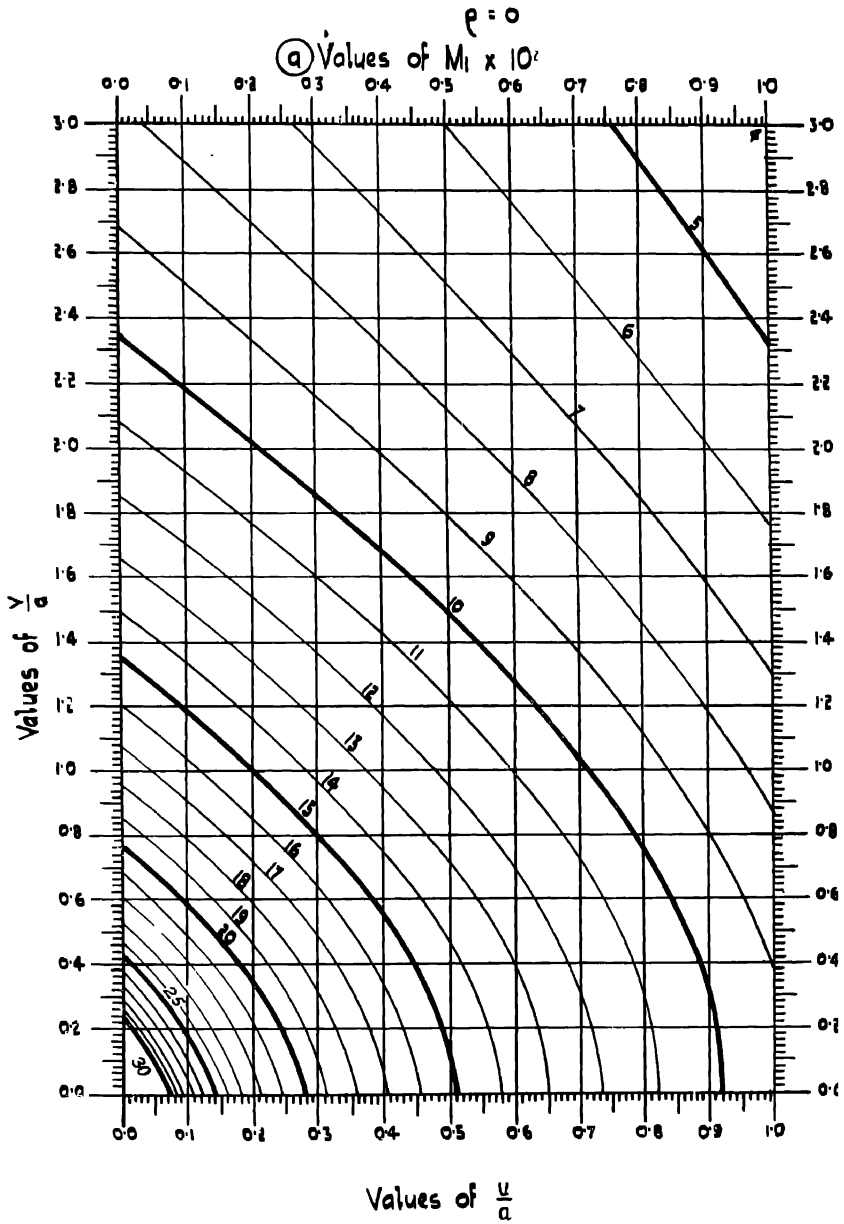

Fig. 57.

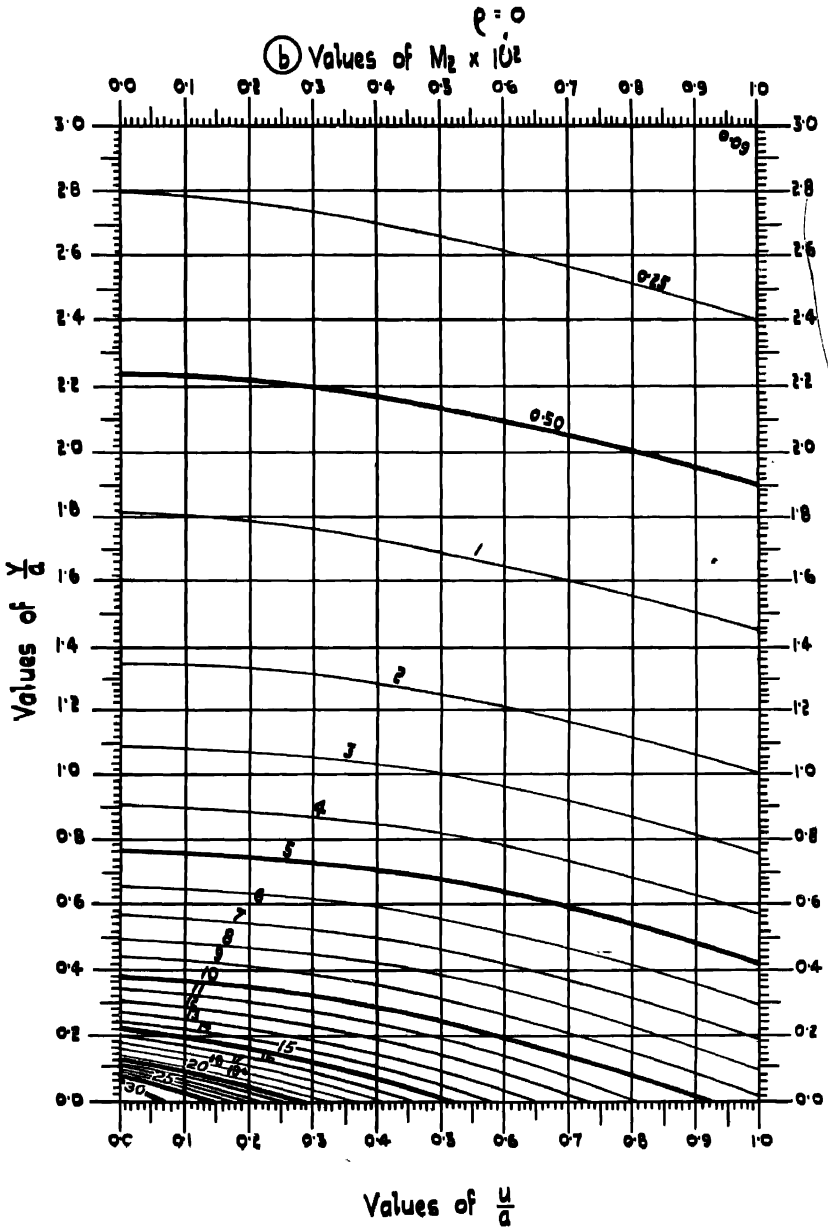
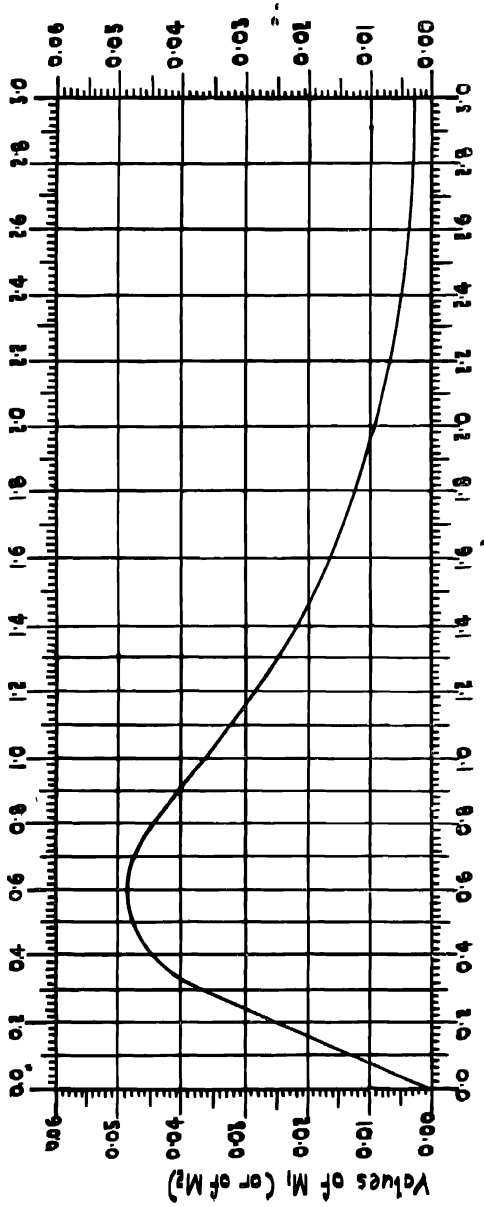

Fig. 58.



Slabs completely loaded.  
 Curves giving the values of  $M_1$  (or  $M_2$ )  
 for a total load  $P = 1$  uniformly distributed over whole area.



Values of  $\rho$

Fig. 61.

**Distribution Steel.**

Whether the loading on a slab supported on two opposite edges is a concentrated load, a uniformly distributed load, or a knife-edge load, the calculation of the longitudinal bending moment by Pigeaud's method (for  $\rho = 0$ ) is a useful basis on which to determine the amount of longitudinal reinforcement, that is, the distribution steel. The Ministry of Transport requirements for such steel are given in *Fig. 42*, and varies from 40 per cent. of the main steel for spans of 4 ft. to 60 per cent. for spans of 10 ft. with a maximum area of 0.5 sq. in. per foot width of slab.

**Example of Slab Design for Concentrated Loads on Single Spans.**

In *Fig. 62* (Example I) the slab is shown supported along two edges only.

(a) SLATER'S METHOD.—Considering first the conditions with the single 6½-ton wheel in the middle of the span.

$$l = 10 \text{ ft.}, l' = 20 \text{ ft.}; t = 3 \text{ in.}; b_0 = 4 \text{ ft. } 6 \text{ in.};$$

$$c = 3 \text{ in.} + (2 \times 3 \text{ in.}) = 9 \text{ in.}; \text{ and from Table VII, } k = 0.75.$$

Then

$$w = 4 \text{ ft. } 6 \text{ in.} + (2 \times 3 \text{ in.}) + 0.75 \times 10 \text{ ft.} = 5 \text{ ft. } + 7 \text{ ft. } 6 \text{ in.} = 12 \text{ ft. } 6 \text{ in.}$$

$$\text{Wheel load} = 6\frac{1}{2} \text{ tons} = 14,000 \text{ lb.}$$

$$50 \text{ per cent. impact} = 7,000 \text{ ,,}$$

$$21,000 \text{ lb.}$$

The moment per foot width of slab is

$$M = \frac{21,000}{4 \times 12.5} \left( 10 - \frac{0.75}{2} \right) 12 = 48,500 \text{ in. lb.}$$

Considering next the axle carrying 10½ tons :

$$w_1 = 5 \text{ ft. } 8 \text{ in.}, b_0 = 1 \text{ ft. } 8 \text{ in.}; t = 3 \text{ in.}; k = 0.75.$$

Then

$$w = \frac{1}{2} [5 \text{ ft. } 8 \text{ in.} + 1 \text{ ft. } 8 \text{ in.} + (2 \times 3 \text{ in.}) + (0.75 \times 10 \text{ ft.})] = 7 \text{ ft. } 8 \text{ in.}$$

The load  $W$  per wheel

$$\frac{1}{2} \times 10.375 \times 2240 = 11,600 \text{ lb.}$$

$$50 \text{ per cent. impact} = 5,800 \text{ ,,}$$

$$17,400 \text{ lb.}$$

The moment per foot width of slab is

$$M = \frac{17,400}{4 \times 7.67} \left( 10 - \frac{0.75}{2} \right) 12 = 65,500 \text{ in. lb.} \text{ This moment is determinative.}$$

(b) PIGEAUD'S METHOD.—Considering first the single 6½-ton concentration :

$$u = 3 \text{ in.} + 2 \times 3 \text{ in.} = 9 \text{ in.}; v = 4 \text{ ft. } 6 \text{ in.} + 2 \times 3 \text{ in.} = 5 \text{ ft.};$$

$$P = 21,000 \text{ lb.}$$

$$\text{Then } \frac{u}{a} = \frac{0.75}{10} = 0.075, \text{ and } \frac{v}{a} = \frac{5}{10} = 0.5.$$

Using the curves for the case  $\rho = 0$  (*Figs. 57 and 58*)

$$M_1 = 21.5 \times 10^{-2} \text{ and } M_2 = 7.8 \times 10^{-2}.$$

REINFORCED CONCRETE BRIDGES

The moment in the direction of the span  $a = 10$  ft. is

$$M = (21.5 + 0.15 \times 7.8)10^{-2} \times 21,000 \times 12 = 57,100 \text{ in. lb.}$$

The moment in the direction of the 20-ft. width is

$$M' = (0.15 \times 21.5 + 7.8)10^{-2} \times 21,000 \times 12 = 27,800 \text{ in. lb.}$$

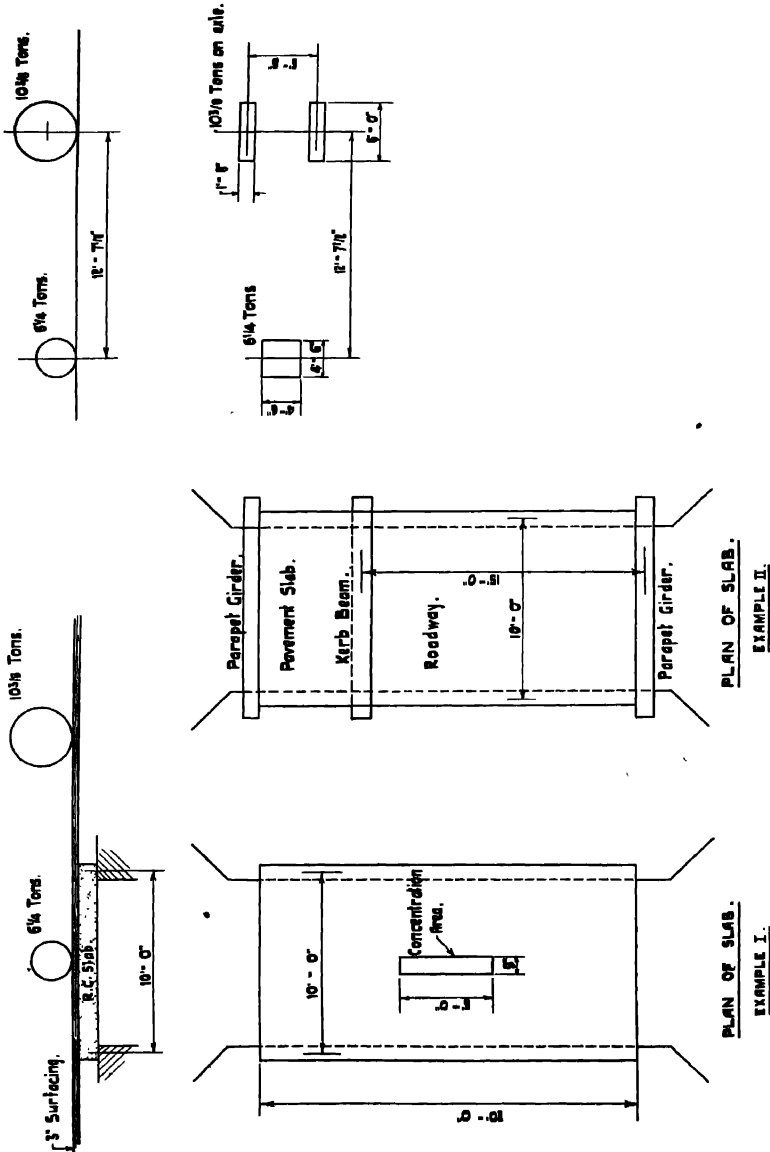

Fig. 62.



Considering next the axle carrying  $10\frac{3}{4}$  tons :

$$u = 9 \text{ in.}; v = 5 \text{ ft. } 8 \text{ in.} + 1 \text{ ft. } 8 \text{ in.} + 6 \text{ in.} = 7 \text{ ft. } 10 \text{ in.}$$

$$P = \text{axle load} = 34,800 \text{ lb.}$$

Then  $\frac{u}{a} = 0.075$  and  $\frac{v}{a} = \frac{7.83}{10} = 0.78$ .

Using the curves for the case  $\rho = 0$  (Figs. 57 and 58)

$$M_1 = 18.6 \times 10^{-2} \text{ and } M_2 = 5 \times 10^{-2}.$$

Then the moment in the direction of the span is

$$M = (18.6 + 0.15 \times 5)10^{-2} \times 34,800 \times 12 = 80,800 \text{ in. lb.}$$

The moment in the direction of the 20-ft. width, which determines the required amount of distribution steel, is

$$M' = (0.15 \times 18.6 + 5)10^{-2} \times 34,800 \times 12 = 32,500 \text{ in. lb.}$$

The  $10\frac{3}{4}$ -ton axle load is therefore determinative.

Assuming a 9-in. slab to be used

$$\text{Weight of slab } 12 \times 9 = 108 \text{ lb. per square foot.}$$

$$3\text{-in. finish} = 30 \text{ " " " "}$$

---

$$138 \text{ lb. per square foot.}$$

The dead load moment is

$$10^2 \times 138 \times 1.5 = 20,700 \text{ in lb.}$$

and the live load moment is  $M = 80,800$  using Pigeaud's method

$$101,500$$

The resistance moment allowing stresses of  $c = 950$  lb. per square inch and  $t = 18,000$  lb. per square inch is

$$\text{R.M.} = 2,084 \times 8^2 = 133,376 \text{ in. lb.}$$

$$A = \frac{101,500}{14,540 \times 8} = 0.87 \text{ sq. in.} \quad A' = \frac{32,500}{14,540 \times 7.4} = 0.30 \text{ sq. in.}$$

A slab 9 in. thick reinforced with  $\frac{3}{4}$ -in. bars at 6-in. centres in the direction of the 10-ft. span can be used, and  $\frac{5}{8}$ -in. distribution bars at 12-in. centres will be sufficient.

**Simple Slab without Ribs and continuous over One Support.**

Let  $I_1 =$  moment of inertia of span  $l_1$ ,  
 $I_2 =$  " " " "  $l_2$ ,  
 and  $\frac{I_1}{I_2} = r.$

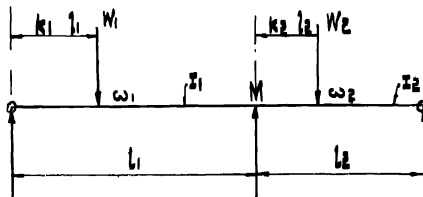

Fig. 63.

In the general case (*Fig. 63*) the negative bending moment over the support is

$$M = - \frac{(w_1 l_1^3 + r w_2 l_2^3)}{8(l_1 + r l_2)} \quad (60)$$

for distributed loadings  $w_1$  and  $w_2$  on the two spans ; this includes the case of loading on one span only by making  $w_1$  or  $w_2$  zero.

For a concentrated load on  $l_1$ ,  $M = - \frac{W_1 l_1^2 (k_1 - k_1^3)}{2(l_1 + r l_2)} \quad (61)$

and for a concentrated load on  $l_2$ ,  $M = - \frac{r W_2 l_2^2 (2k_2 - 3k_2^2 + k_2^3)}{2(l_1 + r l_2)} \quad (62)$

From these values the distribution of the bending moments across the span can be determined graphically for any case.

A commonly occurring case in bridge work is when  $l_1 = l_2 = l$ ,  $I_1 = I_2 = I$  and  $r = 1$ , and for bending the following cases apply.

Moment over Support—

Due to dead loading  $M_d = - 0.125 w_d l^2 \quad (63)$

Due to distributed live loading  $M_l' = - 0.125 w_l l^2 \quad (64)$

Due to knife-edge live loading  $M_l'' = - 0.096 W l \quad (65)$

$$M_{neg.} = M_d + M_l' + M_l'' \quad (66)$$

The value of  $w_l$  for the live load is taken from *Table IV* or from *Fig. 42*, and  $W$  is invariable at 2700 lb. per foot width of slab.

Maximum Positive Bending Moments in Spans -

Due to dead loading  $M_d = 0.07 w_d l^2 \quad (67)$

Due to distributed live loading  $M_l' = 0.095 w_l l^2 \quad (68)$

Due to knife-edge live loading  $M_l'' = 0.207 W l \quad (69)$

$$M_{pos.} = M_d + M_l' + M_l'' \quad (70)$$

Calculation of the maximum moments is generally sufficient in the design of simple slabs of this type, remembering that the contraflexure point occurs at about one-quarter of the span measured from the central support.

The maximum shearing occurring at the central support is

$$S = \frac{5}{8} (w_d + w_l) l + W \quad (71)$$

At the end supports

$$S' = \frac{3}{8} (w_d + w_l) l + W \quad (72)$$

It is not usually necessary to calculate the bond stress adjoining the central support since ample steel must be placed here to deal with the moments. For the bond stress at the free ends it is sufficiently accurate to use the formulæ given for free spans, allowing  $\frac{3}{4}l$  in place of  $l$  for the dead loading and the full span for live loading.

If calculations are to be made for pure concentrations the empirical method given for free spans on pages 56 to 59 can be used, employing, however, the lower values for  $k$  given in *Table VIII* instead of those in *Table VII*.

TABLE VIII.

| $\frac{l'}{l}$ | $k$  | $\frac{l'}{l}$ | $k$  | $\frac{l'}{l}$ | $k$  | $\frac{l'}{l}$ | $k$  |
|----------------|------|----------------|------|----------------|------|----------------|------|
| 0.1            | 0.1  | 0.6            | 0.46 | 1.1            | 0.57 | 1.6            | 0.63 |
| 0.2            | 0.2  | 0.7            | 0.49 | 1.2            | 0.59 | 1.7            | 0.64 |
| 0.3            | 0.29 | 0.8            | 0.52 | 1.3            | 0.60 | 1.8            | 0.65 |
| 0.4            | 0.36 | 0.9            | 0.54 | 1.4            | 0.62 | 1.9            | 0.65 |
| 0.5            | 0.42 | 1.0            | 0.56 | 1.5            | 0.62 | 2.0            | 0.65 |

In using Pigeaud's theoretical method in this case an exact treatment for continuity would be very difficult and has not been obtained. It is probably sufficient to allow

$$M_{108} = 0.83M \quad (73)$$

in the spans, and

$$M_{neg} = -0.50M \quad (74)$$

over the supports, where  $M$  = the "free" moment calculated by Pigeaud's method, for a concentrated load on one span only.

**Simple Slabs without Ribs and continuous over Three Spans.**

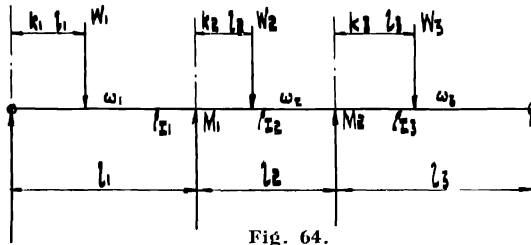

In the general case (Fig. 64) for distributed loading, when  $\frac{l_1}{l_2} = r$  and  $\frac{l_2}{l_3} = s$ ,

the support moments are 
$$M_1 = -\frac{ce}{ae - bd} \cdot \frac{bf}{ad} \quad (75)$$

and 
$$M_2 = -\frac{af - cd}{ae - bd} \quad (76)$$

where  $a = 2(l_1 + rl_2)$ ,  $b = rl_2$ ,  $c = \frac{1}{2}(wl_1^3 + rw_2l_2^3)$ ,  $d = l_2$ ,  $e = 2(l_2 + sl_3)$ ,  $f = \frac{1}{2}(w_2l_2^3 + sw_3l_3^3)$ .

For point loads  $M_1$  and  $M_2$  are given by the same equations where

$$\begin{aligned} a &= 2(l_1 + rl_2) \\ b &= rl_2 \\ c &= W_1l_1^2(k_1 - k_1^3) + rW_2l_2^2(2k_2 - 3k_2^2 + k_2^3) \\ d &= l_2 \\ e &= 2(l_2 + sl_3) \\ f &= W_2l_2^2(k_2 - k_2^3) + sW_3l_3^2(2k_3 - 3k_3^2 + k_3^3). \end{aligned}$$

From these equations the distribution of moments can be obtained graphically for any case.

Frequently for bridge work the spans and moments of inertia are equal and the concentrations can be replaced by a single value  $W = 2700$  lb. per foot width. The following cases then apply.

Maximum Negative Moments over either Support—

$$\text{Due to dead loading } M_d = -0.10w_d l^2 \quad (77)$$

$$\text{Due to distributed live loading } M_l = -0.12w_l l^2 \quad (78)$$

$$\text{Due to knife-edge loading } M_i' = -0.103Wl \quad (79)$$

$$M = M_d + M_l + M_i' \quad (80)$$

Maximum Positive Moments in the Two End Spans—

$$\text{Due to dead loading } M_d = 0.08w_d l^2 \quad (81)$$

$$\text{Due to distributed live loading } M_l = 0.10w_l l^2 \quad (82)$$

$$\text{Due to knife-edge live loading } M_i' = 0.20Wl \quad (83)$$

$$M = M_d + M_l + M_i' \quad (84)$$

Maximum Positive Moments at Centre of Middle Span—

$$\text{Due to dead loading } M_d = 0.025w_d l^2 \quad (85)$$

$$\text{Due to distributed live loading } M_l = 0.075w_l l^2 \quad (86)$$

$$\text{Due to knife-edge live loading } M_i' = 0.175Wl \quad (87)$$

$$M = M_d + M_l + M_i' \quad (88)$$

In some cases it is necessary to check the negative moments occurring near the middles of the spans, where the live load is large compared to the dead load.

The values are given by the following equations.

Minimum Moments towards the Centres of the Two End Spans—

$$\text{Dead load } M_d = +0.075w_d l^2 \quad (89)$$

$$\text{Distributed live load } M_l = -0.025w_l l^2 \quad (90)$$

$$\text{Knife-edge load } M_i' = -0.04Wl \quad (91)$$

$$M = M_d + M_l + M_i' \quad (92)$$

Minimum Moments towards the Centre of the Middle Span—

$$\text{Dead load } M_d = +0.025w_d l^2 \quad (93)$$

$$\text{Distributed live load } M_l = -0.05w_l l^2 \quad (94)$$

$$\text{Knife-edge load } M_i' = -0.04Wl \quad (95)$$

$$M = M_d + M_l + M_i' \quad (96)$$

Should one or both of these values of  $M$  be negative, reinforcement should be placed near the top of the slab. In such cases the negative moments at the points of contraflexure for dead loading should also be calculated as follows.

Negative Moment at Dead-Load Contraflexure Points in End Spans—

Contraflexure point at  $0.2l$  from interior support.

$$\text{Distributed live load } M_l = -0.04w_l l^2 \quad (97)$$

$$\text{Knife-edge load } M_i' = -0.064Wl \quad (98)$$

Negative Moment at Dead-Load Contraflexure Points in Middle Span—

Contraflexure points at  $0.28l$  from the supports.

$$\text{Distributed live load } M_l = -0.05w_l l^2 \quad (99)$$

$$\text{Knife-edge load } M_i' = -0.067Wl \quad (100)$$

The required areas of top reinforcement having been calculated from these values, towards the centres of spans and at the contraflexure points, and knowing

the required areas over the supports, the position of the top reinforcement can generally be judged without drawing the moment and resistance diagrams.

The shearing forces are calculated as follows.

At End Supports—

|                       |                   |       |
|-----------------------|-------------------|-------|
| Dead load             | $S_d = 0.4w_d l$  | (101) |
| Distributed live load | $S_l = 0.45w_l l$ | (102) |
| Knife-edge load       | $S'_i = W$        | (103) |

In End Spans at Interior Supports—

|                       |                   |       |
|-----------------------|-------------------|-------|
| Dead load             | $S_d = 0.6w_d l$  | (104) |
| Distributed live load | $S_l = 0.62w_l l$ | (105) |
| Knife-edge load       | $S'_i = W$        | (106) |

In Middle Span—

|                       |                   |       |
|-----------------------|-------------------|-------|
| Dead load             | $S_d = 0.5w_d l$  | (107) |
| Distributed live load | $S_l = 0.58w_l l$ | (108) |
| Knife-edge load       | $S'_i = W$        | (109) |

For the bond stresses at the free ends of the end spans it is sufficiently correct to use the method given for free spans, substituting  $\frac{4l}{5}$  in place of  $l$  for dead loading and the full span for live loading.

If calculations are required for concentrations, the empirical method previously given for free spans on pages 56 to 59 can be used, but using the lower values for  $k$  given in *Table IX*.

TABLE IX.

| $\frac{l'}{l}$ | $k$  | $\frac{l'}{l}$ | $k$  | $\frac{l'}{l}$ | $k$  | $\frac{l'}{l}$ | $k$  |
|----------------|------|----------------|------|----------------|------|----------------|------|
| 0.1            | 0.1  | 0.6            | 0.43 | 1.1            | 0.51 | 1.6            | 0.55 |
| 0.2            | 0.2  | 0.7            | 0.45 | 1.2            | 0.52 | 1.7            | 0.55 |
| 0.3            | 0.29 | 0.8            | 0.47 | 1.3            | 0.53 | 1.8            | 0.55 |
| 0.4            | 0.35 | 0.9            | 0.49 | 1.4            | 0.54 | 1.9            | 0.55 |
| 0.5            | 0.40 | 1.0            | 0.50 | 1.5            | 0.55 | 2.0            | 0.56 |

In using Pigeaud's method it should be sufficient to use the values :

$$M_{\text{pos.}} = 0.82M \text{ in end spans} \quad (110)$$

$$M_{\text{pos.}} = 0.70M \text{ in middle span} \quad (111)$$

$$M_{\text{neg.}} = -0.40M \text{ over the supports} \quad (112)$$

where  $M$  = the free moment by Pigeaud's method for a load on one span only.

**Simple Slab without Ribs and continuous over Four Spans.**

For equal spans and uniform moments of inertia the following values can be used.

## Maximum Negative Moments over the Second and Fourth Supports—

|                                 |                        |   |   |   |   |       |
|---------------------------------|------------------------|---|---|---|---|-------|
| Due to dead loading             | $M_d = - 0.107w_d l^2$ | . | . | . | . | (113) |
| Due to distributed live loading | $M_l = - 0.121w_l l^2$ | . | . | . | . | (114) |
| Due to knife-edge loading       | $M_l' = - 0.103Wl$     | . | . | . | . | (115) |

## Maximum Negative Moments over Third Support—

|                                 |                        |   |   |   |   |       |
|---------------------------------|------------------------|---|---|---|---|-------|
| Due to dead loading             | $M_d = - 0.071w_d l^2$ | . | . | . | . | (116) |
| Due to distributed live loading | $M_l = - 0.107w_l l^2$ | . | . | . | . | (117) |
| Due to knife-edge loading       | $M_l' = - 0.085Wl$     | . | . | . | . | (118) |

## Maximum Positive Moments in First and Fourth Spans—

|                                 |                        |   |   |   |   |       |
|---------------------------------|------------------------|---|---|---|---|-------|
| Due to dead loading             | $M_d = + 0.077w_d l^2$ | . | . | . | . | (119) |
| Due to distributed live loading | $M_l = + 0.099w_l l^2$ | . | . | . | . | (120) |
| Due to knife-edge loading       | $M_l' = + 0.205Wl$     | . | . | . | . | (121) |

## Maximum Positive Moments in Second and Third Spans—

|                                 |                        |   |   |   |   |       |
|---------------------------------|------------------------|---|---|---|---|-------|
| Due to dead loading             | $M_d = + 0.036w_d l^2$ | . | . | . | . | (122) |
| Due to distributed live loading | $M_l = + 0.080w_l l^2$ | . | . | . | . | (123) |
| Due to knife-edge loading       | $M_l' = + 0.173Wl$     | . | . | . | . | (124) |

## Minimum Moments at Centres of First and Fourth Spans—

|                                 |                        |   |   |   |   |       |
|---------------------------------|------------------------|---|---|---|---|-------|
| Due to dead loading             | $M_d = + 0.071w_d l^2$ | . | . | . | . | (125) |
| Due to distributed live loading | $M_l = - 0.027w_l l^2$ | . | . | . | . | (126) |
| Due to knife-edge loading       | $M_l' = - 0.040Wl$     | . | . | . | . | (127) |

## Minimum Moments at Centres of Second and Third Spans—

|                                 |                        |   |   |   |   |       |
|---------------------------------|------------------------|---|---|---|---|-------|
| Due to dead loading             | $M_d = + 0.036w_d l^2$ | . | . | . | . | (128) |
| Due to distributed live loading | $M_l = - 0.045w_l l^2$ | . | . | . | . | (129) |
| Due to knife-edge loading       | $M_l' = - 0.038Wl$     | . | . | . | . | (130) |

For more than four equal spans it is usually sufficient to design the end spans for the end-span values already given, and all the interior spans as for spans 2 and 3; the negative moments over the third and fourth supports are to be taken from the values given for the third support.

For unequal spans, tables (see, for example, G. Griot, "Kontinuierliche Träger Tabellen") are available and should be used, since calculations by the Equation of Three Moments are very troublesome and are only justifiable in the case of girder design. Alternatively, moment-distribution methods are available.

**Rectangular Slabs supported along Four Sides.**

The use of rectangular slabs whose sides do not greatly differ in length (the ratio  $\frac{l}{b}$  not being less than 2) offers great advantages by securing a monolithic structure relatively free from temperature and contraction cracks. Such use has been relatively restricted mainly on account of the uncertainty of the calculations, especially as regards concentrated loading and continuity. From practical experience, however, it is generally considered that these slabs possess exceptionally large factors of safety when the ordinary methods of calculation are used.

The following method of calculation based upon Pigeaud's theory is suggested as being conservative.

**FREELY-SUPPORTED SLABS.**—The factors for midpoint bending moments due to dead loading are obtained from *Table X*.

$$M_d = K_1 w_d l^2 \text{ across shorter span } l$$

$$M_d = K_2 w_d l'^2 \text{ ,, larger span } l'$$

TABLE X.

| $\frac{l}{l'}$ | $K_1$ | $K_2$ | $\frac{l}{l'}$ | $K_1$ | $K_2$  |
|----------------|-------|-------|----------------|-------|--------|
| 1.0            | 0.043 | 0.043 | 0.5            | 0.098 | 0.008  |
| 0.9            | 0.051 | 0.034 | 0.4            | 0.113 | 0.005  |
| 0.8            | 0.060 | 0.027 | 0.3            | 0.121 | 0.002  |
| 0.7            | 0.072 | 0.020 | 0.2            | 0.122 | 0.0015 |
| 0.6            | 0.085 | 0.013 | 0.1            | 0.124 | 0.001  |

Where continuity has to be allowed for the following values can be used :

End spans : Positive moment =  $\frac{7}{10} M_d$  ; negative moment =  $\frac{9}{10} M_d$

Interior spans : ,, =  $\frac{2}{5} M_d$  =  $\frac{3}{5} M_d$

For design in accordance with the Ministry of Transport's requirements the equivalent distributed live loading plus a knife-edge loading is not regarded as applicable to square or rectangular panels. In such cases the panels are usually calculated for a single concentration, for example, a load of 20 tons distributed on an area of 24 in. by 3 in. When actual load concentrations have to be allowed for in this way Pigeaud's curves (*Figs. 49-59*) may be used. In applying the results it does not seem admissible to neglect Poisson's ratio, as is sometimes done, since the results obtained will be erroneous \* The method of using these curves is as follows :

(1) Determine  $u$  and  $v$ , the sides of the concentration area, similarly to the method previously given for concentrations on slabs spanning in one direction only.

For a single concentration (*Fig. 65*),  $u$  or  $v$  = the corresponding width of the wheel + twice the thickness of the road finish.

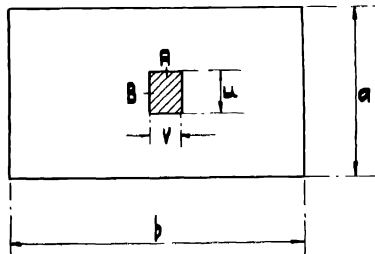

Fig. 65.

\* *Table X* is based on Poisson's ratio = 0, which is in accordance with British practice for the condition of slab completely loaded.

For two concentrations it is usually sufficient to add, in one direction, the distance between the wheels and thus obtain an equivalent rectangle, the other dimension being unaltered.

(2) Calculate  $\rho = \frac{a}{b} \frac{u}{a}$ , and  $\frac{v}{b}$ .

(3) Pigeaud's curves (Figs. 49 to 56) give values corresponding to  $\rho = 0.9, 0.8, 0.707, 0.6, 0.5, 0.4, 0.3$ , and  $0.2$ . In each case the upper set of curves gives  $M_1$  corresponding to the values of  $\frac{u}{a}, \frac{v}{b}$ , and the lower set the values of  $M_2$ . (The case  $\rho = 1$  is a special one, only one set of curves being given;  $M_2$  is obtained by substituting  $\frac{v}{a}$  and  $\frac{u}{b}$  in place of  $\frac{u}{a}$  and  $\frac{v}{b}$  (Fig. 59).

(4) Calculate

$$M = \text{moment at the centre of the slab across span } a \\ = (M_1 + 0.15M_2)P \times 10^{-2} \quad \dots \quad (131)$$

$$M' = \text{moment at the centre of the slab across span } b \\ = (0.15M_1 + M_2)P \times 10^{-2} \quad \dots \quad (132)$$

$M_1$  and  $M_2$  are the actual numbers written against the curves.

The value  $0.15$  is the assumed figure for Poisson's ratio, and the results are given in foot pounds per foot band of slab,  $P$  being the amount of the concentration in pounds.

To allow for continuity where it exists, four-fifths of these values are taken. Shear force per foot width around the concentration :

$$\text{If } u > v, S_A = \frac{P}{3u}, S_B = \frac{P}{2u + v} \quad \dots \quad (133)$$

$$\text{If } u < v, S_A = \frac{P}{3v}, S_B = \frac{P}{2v + u} \quad \dots \quad (134)$$

For the shears along the supports, the method given for simple slab concentrations may be used (pp. 57 to 59).

EXAMPLE.—Conditions being as in Example I (Fig. 62) but with parapet girders on each side of the deck of the bridge and a kerb beam adjoining the footpath (see Fig. 62, Example II), the slab is to be regarded as supported along four sides with spans of 10 ft. and 15 ft. The design is required according to Pigeaud's method.

Considering first the condition with the single  $6\frac{1}{4}$ -ton wheel in the middle of the span :

$$a = 10 \text{ ft.}, b = 15 \text{ ft.}, u = 9 \text{ in.}, v = 4 \text{ ft. } 6 \text{ in.} + 2 \times 3 \text{ in.} = 5 \text{ ft.}$$

$$\text{Then } \rho = \frac{10}{15} = 0.67, \frac{u}{a} = \frac{0.75}{10} = 0.075, \text{ and } \frac{v}{b} = \frac{5}{15} = 0.33.$$

From the curves for  $\rho = 0.707$ , the nearest value to  $0.67$ ,

$$M_1 = 20 \times 10^{-2} \text{ and } M_2 = 9.5 \times 10^{-2}.$$

$$\text{Then } M = [20 + (0.15 \times 9.5)]21,000 \times 10^{-2} \times 12 = 54,000 \text{ in. lb.} \\ M' = [(0.15 \times 20) + 9.5]21,000 \times 10^{-2} \times 12 = 31,500 \text{ in. lb.}$$



Considering next the axle carrying the 10 $\frac{3}{8}$ -ton load and placed in the middle of the span :

$$u = 9 \text{ in.}, v = 7 \text{ ft. } 10 \text{ in.}, 2P = \text{axle load} = 34,800 \text{ lb.}$$

Then  $\frac{u}{a} = \frac{0.75}{10} = 0.075, \frac{v}{b} = \frac{7.83}{15} = 0.52, \text{ and } \rho = \frac{10}{15} = 0.67.$

From the curves ( $\rho = 0.707$ ) with

$$M_1 = 16.6 \times 10^{-2} \text{ and } M_2 = 6.8 \times 10^{-2}.$$

Then  $M = [16.6 + (0.15 \times 6.8)]10^{-2} \times 34,800 \times 12 = 73,600 \text{ in. lb.}$

$$M' = [(0.15 \times 16.6) + 6.8]10^{-2} \times 34,800 \times 12 = 38,800 \text{ ,,}$$

From Table X,  $K_1 = 0.076$  and  $K_2 = 0.018$ , corresponding to  $\frac{l}{v} = 0.667.$

Then  $M_a = 10^2 \times 138 \times 0.076 \times 12 = 12,600 \text{ in. lb.}$   
 $M_l = 73,600 \text{ ,,}$

Total moment in direction of 10-ft. span = 86,200 in. lb.

$$M_a' = 15^2 \times 138 \times 0.018 \times 12 = 6,700 \text{ in. lb.}$$

$$M_l' = 38,800 \text{ ,,}$$

Total moment in direction of 15-ft. span = 45,500 in. lb.

Using as in Example I (p. 73) a slab 9 in. thick

$$A = \frac{86,200}{14,540 \times 8} = 0.74 \text{ sq. in.}$$

or  $\frac{3}{4}$ -in. bars at 7-in. centres in the direction of the 10-ft. span.

$$A' = \frac{45,500}{14,540 \times 7.4} = 0.42 \text{ sq. in.}$$

or  $\frac{5}{8}$ -in. distribution bars at 8-in. centres.

### Practical Considerations.

The bending moment coefficients given in the foregoing for slabs spanning in one direction over two or more spans are derived from a theoretical analysis based on the assumptions that the supports are knife-edge supports and are maintained level. If the slab is monolithic with the supporting girders, due to the unequal deflection of the latter, when the slab is loaded with live load, neither of these assumptions is quite true. The effect of the slab being monolithic with the girders is to induce a negative bending moment in the slab at the end supports and to reduce the negative and positive bending moments elsewhere. If the girders deflect unequally, the result is to decrease the negative bending moments at the supports and increase the mid-span positive moments. The assumption of uniform moment of inertia is more or less true for a continuous slab.

To allow for practical conditions differing from the theoretical assumptions, the following rules apply.

(i) Calculate the maximum bending moments at midspan and the support in accordance with the theoretical formulæ ; reduce the negative bending moments at the support by 15 per cent. and add the amount of moment so deducted to the positive bending moments in the spans on either side of the support.

(ii) For negative bending moments at midspan due to live loading on adjacent spans, adopt the rule : Where the ratio of live to dead load exceeds two, design for a possible negative bending moment at midspan equal to  $\frac{l^2}{24} \left( \frac{w_l}{2} - w_d \right)$  ft. lb.

SECTION B—GIRDER BRIDGES OF ONE SPAN.

Simply-Supported Girder Spans with Longitudinal Beams.

DEAD LOADING.

Let  $w_d$  = total dead loading in lb. per linear foot, including the weight of the beam,  
 then  $M_d = 1.5w_d l^2$  in. lb. .

The shear at any point is  $S_d$   
 where  $x$  = the distance of the point from the centre of the span (*Fig. 66*).

LIVE LOADING.

When designing to the requirements of the Ministry of Transport the live load consists of two parts :

A uniformly distributed loading given by *Table XI* and a knife-edge loading (*Fig. 42*).

TABLE XI.

| Loaded length<br>ft m | Live load<br>lb. per square foot |
|-----------------------|----------------------------------|
| 8 0                   | 444                              |
| 8 6                   | 374                              |
| 9 0                   | 314                              |
| 9 6                   | 265                              |
| 10 0 to 75 0          | 220                              |
| 75 0 to 200           | 220 to 180                       |

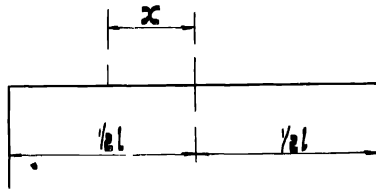

Fig. 66.

(a) For the former the central moment and end shear are

$$M_l = 1.5w_l l^2 \text{ in. lb. . . . . (3)}$$

$$S_l = \frac{1}{2}w_l l \text{ lb. . . . . (4)}$$

where  $w_l = 180b$  to  $444b$  according to the span,  $b$  being the distance between girders.

It is usually necessary to calculate the shear at the centre; this is given by the formula

$$S_c = \frac{1}{8}w_i'l \quad \dots \quad (5)$$

where  $w_i' = b \times$  tabular rate of loading for  $\frac{1}{2}$  span.

In cases where it is necessary to calculate the shear at various points (Fig. 66) in the span

$$S_x = \frac{w_x \left(x + \frac{l}{2}\right)^2}{2l} \quad \dots \quad (6)$$

where  $w_x =$  tabular rate of loading for a span of  $\frac{l}{2} + x$  and  $x =$  distance of the point from the centre line of the beam.

(b) A knife-edge loading  $W = 2700$  lb. per foot.

The loading is assumed to act at right angles to the span and  $P =$  total load  $= Wb = 2700b$ .

$$M_i' = \frac{Pl}{4} \text{ ft. lb.} = 3Pl \text{ in. lb. at the centre} \quad \dots \quad (7)$$

and 
$$M_x' = 3Pl \left(l - \frac{4x^2}{l^2}\right) \text{ at any other point } x \quad \dots \quad (8)$$

$$S_i' = P \text{ at the supports} \quad \dots \quad (9)$$

$$S_x' = P \left(\frac{1}{2} + \frac{x}{l}\right) \text{ at any point } x \quad \dots \quad (10)$$

For single-span bridges freely supported at the ends and spans of 16 ft. to 65 ft, tee-beams are commonly used; above 65 ft., as the extreme limit, it is better to use some form of arch or rigid frame design.

The general arrangement is to span the crossing with several parallel girders on which the deck slab is carried. The spacing of the longitudinal girders may vary between 5 ft. and 10 ft., but approximately 8 ft. is the most usual dimension.

In cases where the question of clearance is of importance, two main parapet girders can be employed, carrying a system of cross girders, which latter can favourably be placed at about 8-ft. centres. The main girders are then carried above the deck slab and form the parapets. This form of construction is best adapted for bridges up to 20 ft. in width, as above this span the cross girders become unduly massive and expensive; it may, however, be imperative to use such a construction, even for greater widths.

In simple girder bridges, spanning between mass abutments, sliding expansion joints should always be placed at one end. These may consist of two machined steel plates  $\frac{1}{2}$  in. to  $\frac{5}{8}$  in. thick separated by tarred paper; the plates should be anchored to the abutments and girders by means of countersunk bolts. Such bolts are usually designed to resist a shear equal to one-third of the end reaction.

There is no necessity, in general, with girder spans to employ either tilting

or roller expansion bearings. The plates should not extend up to the face of the abutment, but should be set back from the face a distance about one-half the width of the plates (*Fig. 67*), so as to avoid local crushing at the edge of the abutment.

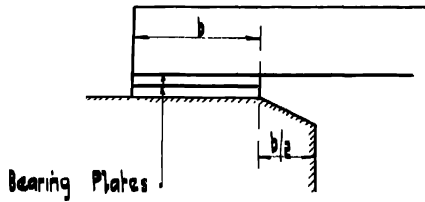

Fig. 67.

In the design of the longitudinal girders it is usual to make the outside girders, even if these only carry footpaths, identical with the inner girders, in order to provide for a possible future widening of the bridge.

CENTRAL SECTION OF GIRDER.—

Let  $M$  = total dead load + live load bending moment

$S$  = total dead load + live load shear.

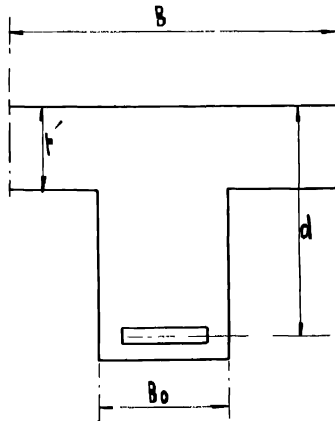

Fig. 68.

The breadth of flange which may be taken is (*Fig. 68*)

$$B \leq \frac{l}{3}, \text{ or } b, \text{ or } 12t' + B_0 \quad (\text{II})$$

whichever is least.

(*Note.*— $b$  is the distance between the centre lines of the girders.)

**Case I.—Compression Steel not used.**—In general, for bridge girders,

it is necessary to choose the minimum allowable value of  $d$  on account of compressive stress. A close first approximation is given by the equation

$$d = \frac{5}{3}t' + \frac{M}{cBt'} \text{ if } n > \alpha \text{ where } \alpha = \frac{t'}{d} \quad (12)$$

$n$  is the depth of neutral axis factor, and  $c$  is the allowable extreme fibre stress in the concrete.

If  $n < \alpha$  the exact value of  $d$  is independent of  $\alpha$  and is obtained at once from the equations in *Table V*.

The Ministry of Transport values for  $c$  are given in *Table VI*.

A particularly exact second approximation, if required, is given by

$$d' = \frac{1}{2n}t' + \frac{M}{cBt'(1-p)} \quad (13)$$

where 
$$n = \frac{mc}{t + mc} \quad (14)$$

$t$  = steel stress,  $m$  = modular ratio and

$$p = \frac{2n - \frac{4}{3} \frac{t'}{d}}{2 \left( 2n - \frac{t'}{d} \right)} \quad (15)$$

$d$  being obtained from the first approximation.

For the stresses and modular ratio specified by the Ministry of Transport,  $n = 0.426$  with  $t = 18,000$  lb. per sq. in. Thus

equation (13) becomes 
$$d' = 1.17t' + \frac{M}{cBt'(1-p)} \quad (13a)$$

and equation (15) becomes 
$$p = \frac{0.426 - 0.67\alpha}{\frac{0.852}{\alpha} - 1} \quad (15a)$$

The value of  $d$  can be determined as a minimum from one or other of these equations, or a greater value may be chosen for constructional reasons.

Should a check on the concrete and steel stresses be required for a given section, this is given approximately by the equation

$$c = \frac{M}{\left(d - \frac{5}{3}t\right)Bt'} \quad (16)$$

$$t = \frac{M}{A \left(d - \frac{t'}{2}\right)} \quad (16')$$

or exactly by 
$$c = \frac{M}{\left(1 - \frac{t'}{2nd}\right)Bt'(d-z)} \quad (17)$$

where 
$$z = \frac{\left(2n - \frac{t'}{d}\right)t'}{2\left(2n - \frac{t'}{d}\right)} \dots \dots \dots (18)$$

$$n = \frac{p'm + \frac{1}{2}\left(\frac{t'}{d}\right)^2}{p'm + \frac{t'}{d}} \dots \dots \dots (19)$$

and 
$$p' = \text{steel ratio} = \frac{\text{area of tension steel}}{Bd} \dots \dots \dots (20)$$

$$t = \text{steel stress} = \frac{M}{A(d - z)} \dots \dots \dots (21)$$

The steel area required in tension is given closely by the following equation :

$$A = \frac{M}{t\left(d - \frac{t'}{2}\right)} \dots \dots \dots (21a)$$

and more closely by 
$$A = \frac{M}{t(d - z)} \dots \dots \dots (21b)$$

For Ministry of Transport requirements 
$$z = \left(\frac{0.426 - 0.67\alpha}{0.852 - \alpha}\right)t' \dots \dots (18a)$$

The diameter  $\delta$  of the reinforcing bars should in general be not greater than 1/150 to 1/200 of the span, and the minimum number of bars is then fixed.

Let  $N$  be the number of bars in a row, then the breadth of beam to accommodate the bars must not be less than  $b = (2N + 1)\delta$  or  $N\delta + 3 \text{ in.} + \frac{3}{4}(N - 1)$ , whichever is the greater.

The breadth of the beam must also satisfy the condition that the shear stress  $v$  shall not be exceeded, that is

$$b \geq \frac{S}{vd} \text{ where } S = \text{maximum shearing force on the beam.}$$

The usual values for  $v$  are as follows :

|        |     |          |           |                     |
|--------|-----|----------|-----------|---------------------|
| 1 : 3  | : 6 | concrete | $v = 120$ | lb. per square inch |
| 1 : 2  | : 4 | „        | $v = 238$ | „ „ „ „             |
| 1 : 1½ | : 3 | „        | $v = 275$ | „ „ „ „             |
| 1 : 1  | : 2 | „        | $v = 300$ | „ „ „ „             |

These are 2½ times the corresponding working stress in the concrete in shear. It is usual to bend up one-half to two-thirds of the total number of reinforcing bars in order to resist diagonal tension stresses.

For a uniformly distributed load, let  $N'$  be the number of bars bent up at

any section counting from the centre of the beam, and  $N$  the total at the centre of the span ; then if  $x =$  the distance from the centre to the section (*Fig. 69*) :

$$x \geq \frac{l}{2} \sqrt{\frac{N'}{N}} \quad \dots \quad (22)$$

$$\text{or } x \geq \frac{l}{2} \sqrt{\frac{A'}{A}} \quad \dots \quad (22a)$$

where  $A'$  is the area bent up and  $A =$  area at centre.

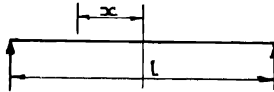

Fig. 69.

In the case of a uniformly distributed load plus a moving knife-edge load, the moment diagram is still parabolic and the previous condition applies. To determine the exact allowable points of bending in the general case with several point loads, it is necessary to draw correct bending and resistance moment diagrams for the case considered.

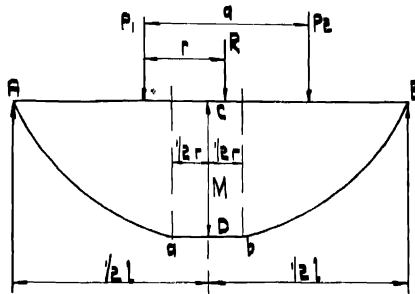

Fig. 70.

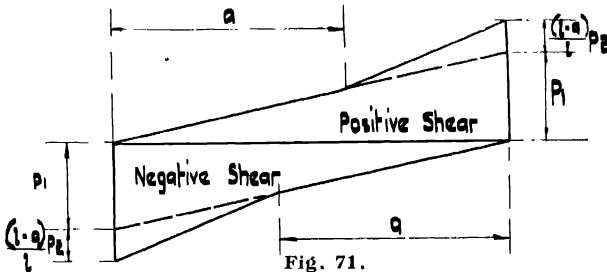

Fig. 71.

Actually the only case at all likely to occur which cannot be reduced to a uniformly distributed load plus the effect of a knife-edge concentration is that for two concentrated loads. The diagrams in this case are obtained as follows (see *Figs. 70 and 71*).

Let  $r$  = the distance of the resultant of the two loads  $P_1$  and  $P_2$  from the heavier load, and  $R = P_1 + P_2$ .

The maximum moment  $M$  is

$$M = \frac{R(l - r)^2}{4l} \tag{23}$$

Set off  $CD = M$  and  $Da = Db = \frac{1}{2}r$ .

Construct two semi-parabolas with vertices at  $a$  and  $b$ . Then  $AabB$  can be taken as the diagram of maximum moments,  $ab$  being regarded as a straight line.

The parabola for the heavier of the two loads should also be drawn to see if it falls below  $AabB$  towards the centre of the span; if so, this portion should be regarded as forming a portion of the true bending moment curve.

The shears are shown in Fig. 71, the loads being assumed to pass in either direction across the span.

The moment and shear diagrams for distributed and live loading are then to be calculated and can be constructed from these diagrams.

The simplest construction for a parabola is according to the diagram (Fig. 72).

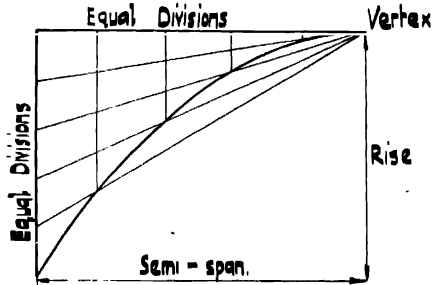

Fig. 72.

The following method can be adopted to determine the spacing of diagonals. In the first place a sketch is made by eye of the spacing, paying attention to the conditions for bending; the stress may be determined in any diagonal bent up at 45 deg. from the equation

$$t_d = \frac{S_x s'}{\frac{3}{8} da \sqrt{2}} \tag{24}$$

where  $s' = \frac{1}{2}(s_1 + s_2)$  (Fig. 73),

$a$  = area of the diagonal,

$S_x$  = maximum shear at the section due to dead load plus live load where no stirrups are provided,

or  $S_x$  = shear at the section less the shearing resistance of the stirrups  $R_x$ , where stirrups are placed in the beam.

The stress  $t_d$  should not, of course, exceed the working stress of the steel, and will usually be considerably less. In no case should  $s'$  be greater than  $\frac{3}{4}d$ ; this can always be arranged, either by choosing a sufficient number of diagonals, or by bringing the number taken sufficiently close to the supports.

To secure an adequate bond to the diagonals, it is usual arbitrarily to assume that the strength of these bars should be developed in the concrete in the upper half of the beam.



If  $l'$  is the length in inches of the diagonal within the top half of the beam,

then 
$$l' \geq \frac{t_d}{400} \times d, \tag{25}$$

the ends of the diagonals being hooked.

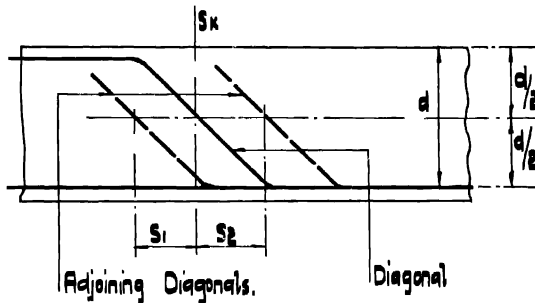

Fig. 73.

In this method of spacing the diagonals, in the case of the diagonal nearest the centre of the beam,  $S_2$  is assumed to equal  $d$  in order that this diagonal may be regarded as protecting the concrete for a distance  $\frac{1}{2}d$  towards the centre.

The shearing resistance of the stirrups can be calculated from the formula

$$R_x = na \times 16,000 \times \frac{\frac{7}{8}d}{e} = \frac{14,000nad}{e} \tag{26}$$

where  $n$  = number of branches,  $a$  = area of one branch of stirrup and  $e$  = spacing of stirrups.

It is easy in all cases, by slight adjustments in the spacing of the diagonals, to obtain practically equal stress in all diagonals, especially as the stirrups can be varied to assist in securing this result. There seems no necessity, therefore, to incur the labour of dividing the diagonal stress diagram, as is sometimes done, into equal parts and placing the diagonals at the centroids of these areas.

In all cases where the concrete shearing stress exceeds the allowable value for plain concrete, the total shear should be resisted by the diagonals and links combined, and no allowance should be taken for the concrete resistance. Where diagonals can resist the whole shear it is a frequent practice to place links to take one-quarter to one-third of the total shear, in addition.

The allowable values for concrete shearing stress are as follows :

|        |     |          |   |   |   |   |     |     |     |        |      |
|--------|-----|----------|---|---|---|---|-----|-----|-----|--------|------|
| I : 3  | : 6 | concrete | . | . | . | . | 40  | lb. | per | square | inch |
| I : 2  | : 4 | "        | . | . | . | . | 95  | "   | "   | "      | "    |
| I : 1½ | : 3 | "        | . | . | . | . | 110 | "   | "   | "      | "    |
| I : I  | : 2 | "        | . | . | . | . | 120 | "   | "   | "      | "    |

The bond stress on the straight bars in the bottom should always be calculated in important cases. This can be done as follows :

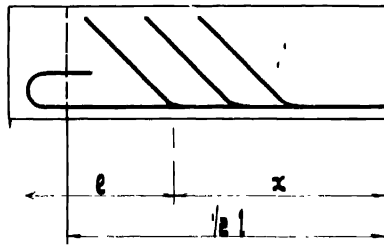

Fig. 74.

Let  $x$  = the distance from the centre line to the diagonal nearest the support (Fig. 74),

$p$  = the perimeter of the straight bars (in.),

$c$  = length from last diagonal to end of straight bars (in.),

$M_x$  = moment at point of bending of last diagonal in in. lb.,

$M_c$  = central moment in m. lb.

$$M_x = M_c \times \left( 1 - \frac{4x^2}{l^2} \right) \text{ in. lb.} \quad (27)$$

Then the bond stress =  $\frac{M_x}{\frac{7}{8}dpc}$  . . . . . (28)

and this should be less than the value given in Table VI on p 55, hooks being provided at the ends of the bars.

**Case II. Top Reinforcement in Longitudinal Girders.**—It is hardly ever necessary to calculate longitudinal girders for steel in compression by the ordinary text-book formulæ. In almost all cases, when the allowable compressive stress in the flange becomes excessive for the maximum depth of girder allowable for headroom, it will be necessary to employ equal steel top and bottom, and the simple formula (29) given below for such equality of reinforcement should be used.

In this case (Fig 75)  $A$  = area of steel in compression, or tension

$$= M/18,000d \quad (29)$$

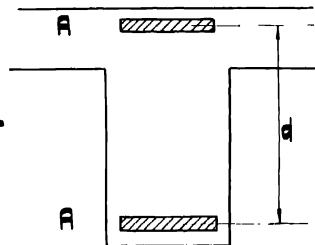

Fig. 75.

if the stress allowed in the steel is 18,000 lb per square inch, the concrete stress not being considered.

The calculations for diagonals, links, and bond stresses are made as before for the ordinary case where the compressive stress is below the allowable value.

Consideration should always be given to the possibility of placing a reasonable proportion of the compressive steel outside the stirrups and within the slab, in order to relieve the concentration of steel at the top, since this may seriously reduce the value of the bond resistance. The chief danger is a settlement of the concrete beneath the top bars, and this should be carefully watched on the site in all such cases.

### Bridge Carried by Two Longitudinal Girders with Cross Beams.

(Figs. 76 and 77.)

For the two longitudinals it is usually sufficiently correct to replace the load concentrations by a uniformly distributed loading, that is, if  $R$  = total load from one cross girder (dead load plus distributed live loads) and  $e$  = spacing of cross girders,  $w = \frac{R}{e}$  and the method given already for simple longitudinal girder

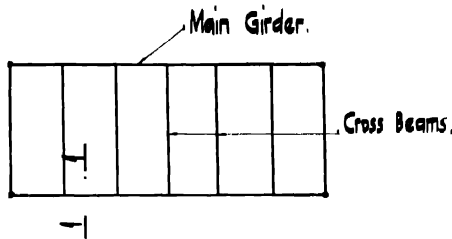

Fig. 76.

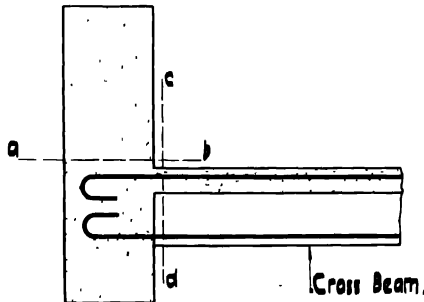

Fig. 77.

bridges applies directly, the knife-edge loading being treated as a single moving concentration. The top flange of the girder will not be directly supported laterally, and this point should be given consideration; the cross beams which stiffen the girders should be equally reinforced at top and bottom adjoining the girders, and the section on the line  $ab$  should be as strong as that on  $cd$ . In calculating the section  $ab$  for bending it should, of course, be remembered that the stirrups are initially stressed due to the shear.

The loading from the cross beams is applied near the bottom of the girders, and the total load should be transferred to the top of the girders by means of hangers passing under the bottom bars of the cross beams and carried up into the compression zone.

CROSS BEAMS.—Let  $l$  = span of cross beams and  $e$  = their spacing (Fig. 78),

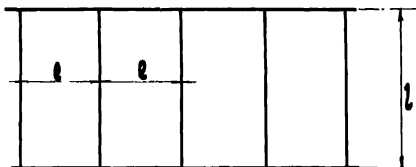

Fig. 78.

then  $w_d, w_b$ , etc., can be calculated and the moments and shears are to be calculated as for longitudinal beams for which the formulæ have already been given.

For the knife-edge loading  $P = Wl = 2700l$  lb., since the load is to be regarded as acting in line with the cross beams.

Then  $M'_l = \frac{Pl}{8}$  ft. lb. = 1.5  $Pl$  in. lb. . . . . (30)

$M'_x = 1.5lP \left( 1 - \frac{4x^2}{l^2} \right)$  in. lb. . . . . (31)

where  $x$  = the distance from the point to mid-span.

$S' = \frac{1}{2}P$  at supports . . . . . (32)

$S_x = \frac{W \left( x + \frac{l}{2} \right)^2}{2l}$  . . . . . (33)

where  $W = 2700$  lb.

BEARING PLATES AT SUPPORTS.—These should be placed in pairs and have machined faces as already described. The bearing area should be such that the pressures on the supports do not exceed the following, when the pressure includes the dead and live loads, lateral loads and eccentricity :

|                      |  |                         |
|----------------------|--|-------------------------|
| Plain concrete       | 1 : 1 : 2 mixture  | 60 tons per square foot |
| „                    | „ 1 : 1½ : 3 „   | 53 „ „ „ „              |
| „                    | „ 1 : 2 : 4 „  | 45 „ „ „ „              |
| „                    | „ 1 : 3 : 6 „ or 1 : 6 all-in aggregate  | 30 „ „ „ „              |
| Masonry or brickwork | with units of crushing strength not less than 10,000 lb per square inch set in 1 : 3 cement mortar | 53 „ „ „ „              |

When the pressure includes the dead and live loads, impact, lurching and centrifugal force it should not exceed the following :

|          |             |                                      |                         |
|----------|-------------|--------------------------------------|-------------------------|
| Concrete | 4 : 1—Plain | 24 tons per square foot ; Reinforced | 36 tons per square foot |
| „        | 6 : 1—      | 20 „ „ „ „                           | 30 „ „ „ „              |
| Granite  | „           | 25 „ „ „ „                           | Sandstone 20 „ „ „ „    |

These stresses can be increased by 20 per cent. if wind pressure, longitudinal forces, and temperature effects are included.

SECTION C—CONTINUOUS GIRDER BRIDGES.

Girder Continuous over One Support (Two Spans)

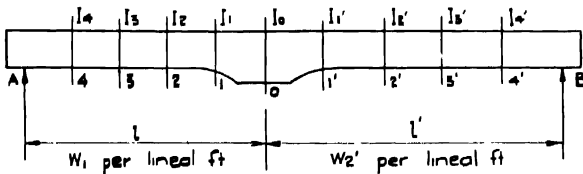

Fig. 79.

DISTRIBUTED LOADING.

In the general case (Fig. 79) let  $I_1, I_2, \dots, I_4$  and  $I_1', I_2', \dots, I_4'$  be the moments of inertia at points dividing each span into five equal parts;  $K_0 = \frac{l}{I_0}$ ,  $K_1 = \frac{l}{I_1}$ ,  $K_2 = \frac{l}{I_2}$  . . . and  $K_0' = \frac{l'}{I_0'}$ ,  $K_1' = \frac{l'}{I_1'}$ ,  $K_2' = \frac{l'}{I_2'}$  . . .

For a distributed loading  $w_1$  lb. per foot on a span, the negative moment over the support due to a loading  $w_1$  on span  $l$  is

$$M = -\frac{6}{5} \frac{l}{s} \cdot w_1 l^2, \text{ very closely . . . . . (1)}$$

where  
and

$$t = 4K_1 + 3K_2 + 2K_3 + K_4 . . . . . (2)$$

$$s = 19(K_0 + K_0') + 48(K_1 + K_1') + 18(K_2 + K_2') + 8(K_3 + K_3') + 3(K_4 + K_4') \quad (3)$$

The negative moment over the support due to a loading  $w_2$  on span  $l$  is

$$M = -\frac{6}{5} \frac{l'}{s'} \cdot w_2 l'^2, \text{ very closely . . . . . (4)}$$

where

$$t' = 4K_1' + 3K_2' + 2K_3' + K_4' . . . . . (5)$$

and  $s$  has the value previously given.

For loading  $w_1$  and  $w_2$  on both spans

$$M = -\frac{6}{5s} (tw_1 l^2 + t'w_2 l'^2) . . . . . (6)$$

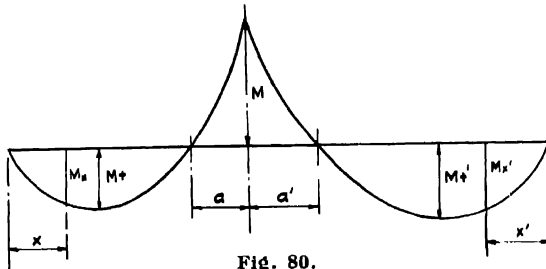

Fig. 80.

At a point  $x$  (Fig. 80) in the span  $l$  the moment is

$$M_x = \left( \frac{1}{2}w_1l + \frac{M}{l} \right)x - \frac{1}{2}w_1x^2 \quad (\text{Note! that } M \text{ is negative.}) \quad (7)$$

The maximum positive moment is

$$M_{\text{pos.}} = \frac{\left( \frac{1}{2}w_1l + \frac{M}{l} \right)^2}{2w_1} \quad \dots \quad (8)$$

and the position of the contraflexure point is given by

$$a = - \frac{2M}{w_1l} \quad \dots \quad (9)$$

In the span  $l'$  the moment at any point is

$$M_x' = \left( \frac{1}{2}w_2l' + \frac{M}{l'} \right)x' - \frac{1}{2}w_2x'^2 \quad \dots \quad (10)$$

and the maximum positive moment is

$$M'_{\text{pos}} = \frac{\left( \frac{1}{2}w_2l' + \frac{M}{l'} \right)^2}{2w_2} \quad \dots \quad (11)$$

The contraflexure point is located by

$$a' = - \frac{2M}{w_2l'} \quad \dots \quad (12)$$

From these equations the moments due to the distributed dead and live loads can be obtained and bending moment diagrams drawn if required; for maximum negative moments live loading must be assumed on both spans; for maximum positive moments live load is assumed only on the span considered. The values of  $s$  and  $t$  are constant for the various cases considered.

The shear in span  $l$  is given by

$$S_A = \frac{1}{2}w_1l + \frac{M}{l} \quad \dots \quad (13)$$

$$S_0 = \frac{1}{2}w_1l - \frac{M}{l} \quad \dots \quad (14)$$

and in span  $l'$  by

$$S_B = \frac{1}{2}w_2l' + \frac{M}{l'} \quad \dots \quad (15)$$

$$S_0' = \frac{1}{2}w_2l' - \frac{M}{l'} \quad \dots \quad (16)$$

$M$  being assumed as a negative quantity, and the different combinations of dead and live loading used to give the maximum value in each case.

CONCENTRATED KNIFE-EDGE LOADING.

For maximum negative moments it is nearly always sufficiently accurate to



assuming the load  $W$  placed at point 3 or 3'. For a load at point 3 the moment at the support is

$$M_{neg.} = -\frac{3}{5} \cdot \frac{t}{s} \cdot Wl \quad (24)$$

where

$$t = (8K_1 + 8K_2 + 8K_3 + 3K_4)$$

and  $s$  has the value already given in formula (19).

For a load at point 3', the moment at the support is

$$M_{neg.} = -\frac{3}{5} \cdot \frac{t'}{s} \cdot Wl' \quad (25)$$

where

$$t = (8K_1' + 8K_2' + 8K_3' + 3K_4') \quad (26)$$

and  $s$  has the value previously given. The corresponding maximum positive moment in span  $l$  for load at point 3 is

$$M_{pos.} = \frac{6}{25} Wl - \frac{2}{5} M \quad (27)$$

a numerical positive value being assumed for  $M$  with the contraflexure point at

$$a = \frac{M}{\left(\frac{2}{5} W + \frac{M}{l}\right)} \quad (28)$$

The corresponding maximum moment in span  $l'$  for load at 3' is

$$M'_{pos.} = \frac{6}{25} Wl' - \frac{2}{5} M' \quad (29)$$

a numerical positive value being assumed for  $M'$  with the contraflexure point at

$$a' = \frac{M'}{\left(\frac{2}{5} W + \frac{M'}{l'}\right)} \quad (30)$$

The maximum positive bending moment diagrams are shown in Fig. 82,  $M_{pos.}$ ,  $M'_{pos.}$ ,  $a$  and  $a'$  being obtained from equations (27) to (30).

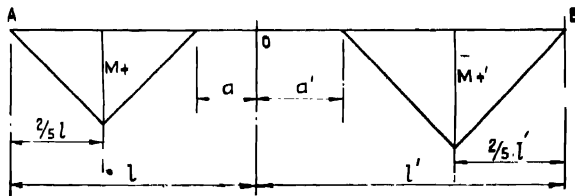

Fig. 82.

By combining the diagrams for the various cases of distributed dead load and live load with those for the negative and positive concentrated knife-edge loadings, resultant diagrams can be obtained giving maxima at all points in the spans. For practical purposes this is necessary for the design of the girder, and for determining the points for stopping off the bars and the arrangement of the steel over the supports and in the spans.





$d$  the effective depth of the beam at any point. The values of  $\alpha$  (Table XII), corresponding to the different percentages of steel

$$p = \frac{100 \times \text{area tension steel}}{bd}$$

give good results for calculated deflections relative to their experimental values.

TABLE XII.

| $p$ | $\alpha$ | $p$ | $\alpha$ |
|-----|----------|-----|----------|
| 0.1 | 0.005    | 1.1 | 0.050    |
| 0.2 | 0.010    | 1.2 | 0.055    |
| 0.3 | 0.017    | 1.3 | 0.057    |
| 0.4 | 0.022    | 1.4 | 0.060    |
| 0.5 | 0.027    | 1.5 | 0.064    |
| 0.6 | 0.030    | 1.6 | 0.067    |
| 0.7 | 0.035    | 1.7 | 0.070    |
| 0.8 | 0.040    | 1.8 | 0.073    |
| 0.9 | 0.045    | 1.9 | 0.075    |
| 1.0 | 0.047    | 2.0 | 0.077    |

These values are obtained by assuming the concrete to have no tensile value and a ratio of moduli equal to 8.

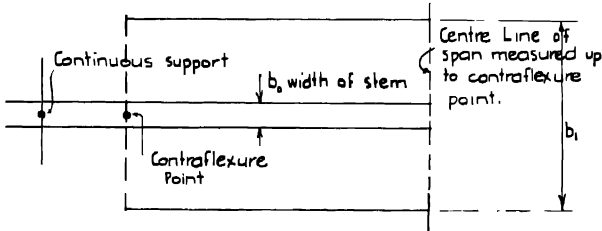

Fig. 83.

With regard to the breadth ( $b$ ) of tee-beam to be assumed at any point, it can be assumed that the maximum value ( $b_1$ ) is equal to the distance between beam centres of full flange width, and that this value decreases abruptly to  $b_0$ , the width of the stem of the beam, at the contraflexure point (Fig. 83). From the contraflexure point to the support the width can be regarded as having a constant value  $b_0$ . From these values, being given the steel percentages and the depths at each point, the values of  $I$  can be calculated and plotted. From the diagram the values of  $I_1, I_2$ , etc., can be found at points 1, 2, etc., and therefore the values of  $\frac{l}{I_1}, \frac{l}{I_2}$ , etc.

In making the calculations, it is necessary to prepare a preliminary design in order to obtain approximate values for  $p$  and for the positions of the contraflexure points. This is usually done by assuming the values of  $K$  to be constant in each span and neglecting the haunching, if any, at the supports. For large and important bridge members with deep haunchings it is often necessary to make

a more exact calculation as indicated; in **I**-section girders (that is, for bridges with a bottom intradosal slab) especially, the values of  $K$  may be small at the supports compared with those at the centre, so that the ordinary method gives very excessive central moments and deficient negative moments over the supports. This is important when minimum depths of girders are required at the centres of spans to meet conditions of clearance.

CASE WHERE MOMENTS OF INERTIA ARE CONSTANT IN EACH SPAN.—Let  $I$  and  $I'$  be the moments of inertia in spans  $l$  and  $l'$ ,  $K = \frac{l}{I}$ ,  $K' = \frac{l'}{I'}$ ,  $w$  and  $w'$  the distributed loads on the two spans, and  $W$  the amount of the concentrated knife-edge load. It is usually sufficient to consider full loading over one or both spans, since partial live loads only affect the positive moments near the support and do not affect the design. The moment over the support due to full distributed loadings is

$$M_0 = \frac{1}{8 \left( 1 + \frac{K'}{K} \right)} \left( w l^2 + \frac{K'}{K} w' l'^2 \right) \quad (48)$$

In span  $l$  (Fig. 84),  $M_x = \frac{1}{2} w x (l - x) + \frac{x}{l} M_0 \quad (49)$

$$M_{\max} = \frac{\left( \frac{1}{2} w l + \frac{M_0}{l} \right)^2}{2w} \quad (50)$$

In span  $l_1$ ,  $M_{x'} = \frac{1}{2} w' x' (l' - x') + \frac{x'}{l'} M_0 \quad (51)$

$$M_{\max} = \frac{\left( \frac{1}{2} w' l' + \frac{M_0}{l'} \right)^2}{2w'} \quad (52)$$

The shears are

$$S_A = \frac{1}{2} w l + \frac{M_0}{l} \quad (53)$$

$$S_B = -\frac{1}{2} w' l' - \frac{M_0}{l'} \quad (54)$$

$$S_0 = \frac{1}{2} w l - \frac{M_0}{l} \quad (55)$$

$$S_0' = \frac{1}{2} w' l' - \frac{M_0}{l'} \quad (56)$$

$M_0$  being assumed negative throughout.

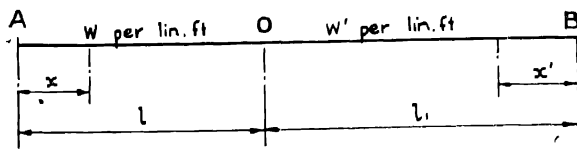

Fig. 84.

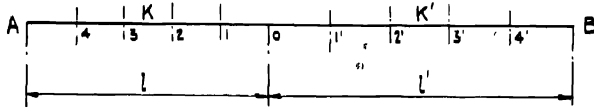

Fig. 85.

For concentrated loads (Fig. 85),

$$M_0 = -cWl \quad (57)$$

also  $M_1, M_2 \dots \text{etc.} = dWl \quad (58)$

for loads on span  $l$ , and

$$M_0' = -c'Wl' \quad (59)$$

$$M_1', M_2' \dots = d'Wl' \quad (60)$$

for loads on span  $l'$ , where  $c$  and  $d$  are obtained as follows:

| Load at point (Fig. 85) | $c$ or $c'$  | $d$ or $d'$   |      |
|-------------------------|--|---|------|
| 1                       | $c_1 = \frac{0.160}{\left(1 + \frac{K''}{K}\right)}$               | $d_1 = \frac{4}{5}\left(\frac{1}{5} - c_1\right)$   | (61) |
| 2                       | $c_2 = \frac{0.196}{\left(1 + \frac{K''}{K}\right)}$               | $d_2 = \frac{3}{5}\left(\frac{2}{5} - c_2\right)$   | (62) |
| 3                       | $c_3 = \frac{0.169}{\left(1 + \frac{K''}{K}\right)}$               | $d_3 = \frac{2}{5}\left(\frac{3}{5} - c_3\right)$   | (63) |
| 4                       | $c_4 = \frac{0.100}{\left(1 + \frac{K''}{K}\right)}$               | $d_4 = \frac{1}{5}\left(\frac{4}{5} - c_4\right)$   | (64) |
| 1'                      | $c_1' = \frac{0.160 \frac{K'}{K}}{\left(1 + \frac{K''}{K}\right)}$ | $d_1' = \frac{4}{5}\left(\frac{1}{5} - c_1'\right)$ | (65) |
| 2'                      | $c_2' = \frac{0.196 \frac{K'}{K}}{\left(1 + \frac{K''}{K}\right)}$ | $d_2' = \frac{3}{5}\left(\frac{2}{5} - c_2'\right)$ | (66) |
| 3'                      | $c_3' = \frac{0.169 \frac{K'}{K}}{\left(1 + \frac{K''}{K}\right)}$ | $d_3' = \frac{2}{5}\left(\frac{3}{5} - c_3'\right)$ | (67) |
| 4'                      | $c_4' = \frac{0.100 \frac{K'}{K}}{\left(1 + \frac{K''}{K}\right)}$ | $d_4' = \frac{1}{5}\left(\frac{4}{5} - c_4'\right)$ | (68) |



For the case of two equal spans, constant moments of inertia, and free end supports, the bending moments for distributed dead load  $w_d$  on both spans, and distributed live loads placed to give the maximum positive or negative moments, are contained in *Table XIII*. For three equal spans with free end supports the bending moments are given in *Table XIV*.

TABLE XIV.—THREE EQUAL SPANS.

| $\frac{x}{l}$ | $w_d$ on all spans | Maximum positive live load moments | Maximum negative live load moments |
|---------------|--------------------|------------------------------------|------------------------------------|
| End Spans     |                    |                                    |                                    |
| 0             | 0                  | 0                                  | 0                                  |
| 0.1           | + 0.035            | + 0.040                            | - 0.005                            |
| 0.2           | + 0.060            | + 0.070                            | - 0.010                            |
| 0.3           | + 0.075            | + 0.090                            | - 0.015                            |
| 0.4           | + 0.080            | + 0.100                            | - 0.020                            |
| 0.5           | + 0.075            | + 0.100                            | - 0.025                            |
| 0.6           | + 0.060            | + 0.090                            | - 0.030                            |
| 0.7           | + 0.035            | + 0.070                            | - 0.035                            |
| 0.8           | 0                  | + 0.040                            | - 0.040                            |
| 0.85          | - 0.021            | + 0.028                            | - 0.049                            |
| 0.90          | - 0.045            | + 0.020                            | - 0.065                            |
| 0.95          | - 0.071            | + 0.017                            | - 0.088                            |
| 1             | - 0.100            | + 0.017                            | - 0.117                            |
| Multiplier    | $w_d l^2$          | $w_l l^2$                          | $w_l l^2$                          |
| Middle Span   |                    |                                    |                                    |
| 0             | - 0.100            | + 0.017                            | - 0.117                            |
| 0.05          | - 0.076            | + 0.014                            | - 0.090                            |
| 0.10          | - 0.055            | + 0.007                            | - 0.062                            |
| 0.15          | - 0.036            | + 0.020                            | - 0.057                            |
| 0.20          | - 0.020            | + 0.030                            | - 0.050                            |
| 0.276         | 0                  | + 0.050                            | - 0.050                            |
| 0.30          | + 0.005            | + 0.055                            | - 0.050                            |
| 0.40          | + 0.020            | + 0.070                            | - 0.050                            |
| 0.50          | + 0.025            | + 0.075                            | - 0.050                            |
| Multiplier    | $w_d l^2$          | $w_l l^2$                          | $w_l l^2$                          |

No universal practice of detailing continuous spans exists, and the following is only one of the many methods. The assumptions on which it is based are: (1) For the negative moment at the supports the section is to be calculated with equal steel at top and bottom in accordance with the "steel beam" theory. This is for the usual case of rectangular ribs, but where there is a slab connecting the soffits of the ribs it may be possible to reduce the bottom steel, (2) The area of bottom steel required over continuous supports should be provided, if possible,

by the crossings of the main steel without the addition of loose bars, (3) The ratios of bent-up to total steel should be equal in each beam, (4) Steel, in addition to the bent-up bars, required at the top over the supports should be provided by straight bars with hooked ends, a proportion being placed within the links and the remainder being placed within the deck slab outside, but close to, the links, and (5) The points where bars are to be bent up are to be determined by consideration of moments and not of diagonal tension; where diagonals do not occur the total shears should be resisted by means of vertical links.



Fig. 87.

Let  $A_1 =$  total positive steel required in span  $AB$  (Fig. 87)  $= a_1 + a_1'$ .

$A_2 =$  " " " " " " "  $BC = a_2 + a_2'$ .

( $a_1$  and  $a_2$  are the areas of the cross-sections of straight bars and  $a_1'$  and  $a_2'$  of cranked bars.)

$A_s =$  total negative steel over the support at  $B$ .

$a_s =$  the extra area of straight steel at the top over the supports in addition to the bars cranked up from the two spans.

Then

$$a_1 = \frac{A_1 A_s}{A_1 + A_2} \quad \dots \quad (73)$$

$$a_2 = \frac{A_2 A_s}{A_1 + A_2} \quad \dots \quad (74)$$

$$a_1' = A_1 - a_1 \quad \dots \quad (75)$$

$$a_2' = A_2 - a_2 \quad \dots \quad (76)$$

it being assumed that  $A_s < (A_1 + A_2)$ .

In cases where  $A_s$  is equal to or greater than  $(A_1 + A_2)$  all the bottom bars should be carried straight through over the supports and additional bottom bars must be placed over the supports. The top bars over the supports are then to be provided entirely by a separate group of bars preferably bent down at intervals at angles of 45 deg.

Also 
$$a_s = A_s - a_1' - a_2' \quad \dots \quad (77)$$

Should this have a negative value it indicates that additional bars are not required at the top over the supports, and some of the cranked bars can be stopped off before reaching the supports.

The areas  $a_1$ ,  $a_2$ ,  $a_1'$ ,  $a_2'$ , and  $a_s$  are now determined, and the correct number and diameter of bars are selected; the latter should be kept as uniform as is convenient.

The case described is the usual one when the section over the supports requires to be doubly reinforced, but in designs where the ribs are connected by a soffit slab compressive reinforcement may be unnecessary. The top steel over the supports can then be obtained by bending up sufficient bars. Then,





the main positive steel. Simplicity of arrangement is also obtained by employing the same total number of bars in the adjoining spans.

Convenient arrangements of the bottom reinforcement for various numbers of bars are given in *Fig. 88*, in which *s* designates the straight bars and *c* those cranked over the supports. In bridge members considerations of shear usually fix the widths of the beams which allow such arrangements, although in ordinary building construction these would not be economical. In all these cases the

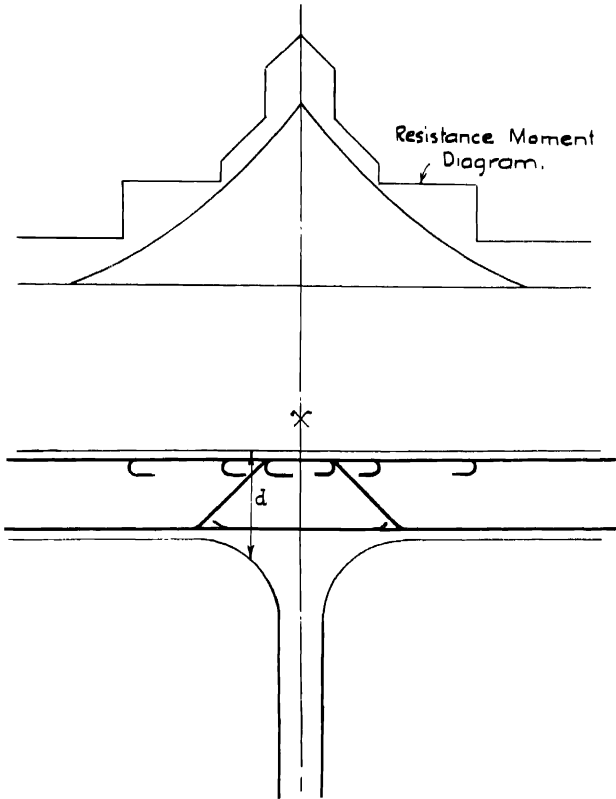

Fig. 89.

bottom row of straight bars should be carried as far as the cranked bars in the same plane of the adjoining span to provide framing for the links. In these arrangements no cranking of straight bars is required at the crossings over supports. In all cases the breadth of beam should be made not less than

$$b = N\delta + 3 + (N - 1)\frac{3}{4} \text{ or } (2N + 1)\delta,$$

whichever is greater, where  $N$  = number of bars in a row and  $\delta$  = diameter of bars.

ARRANGEMENT OF STEEL OVER SUPPORTS.—The bending of the bars adjoining the supports is determined by the values of the maximum negative moments. In important girders with splays or haunches it is necessary to draw bending and resistance moment diagrams.

In drawing the resistance moment diagram (*Fig. 89*), it is best to calculate the resistance of one bar throughout the span in each of the groups  $a_1'$  and  $a_2'$ , using the formulæ  $m = \frac{1}{2}dtw$  and  $m' = \frac{1}{2}dtw'$ .

In these expressions  $d$  is the effective depth at each point and  $w$  and  $w'$  are the areas of steel for one bar in each of the two adjoining spans;  $t$  is the working steel stress.

Referring to *Fig. 90*,  $AB$  is the resistance diagram for one bar of group  $a_1'$

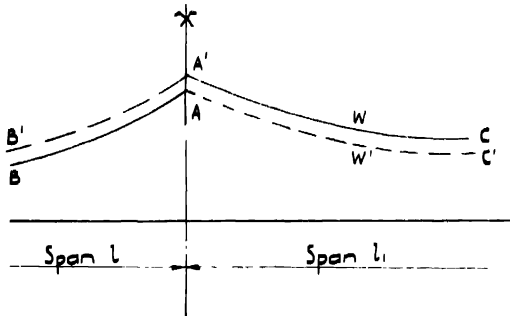

Fig. 90.

(span  $l$ );  $A'B'$  is the resistance diagram for one bar of group  $a_2'$  from adjoining span (span  $l_1$ );  $A'C$  and  $AC$  are the resistance diagrams for one bar of group  $a_2'$  (span  $l_1$ ), and for one bar of group  $a_1'$  (span  $l$ ) respectively. The points where bars may be stopped off or cranked down can then be easily found, the resultant diagram of resistance moments being drawn point by point, using a pair of dividers. It is necessary to check that every bar counted as acting at the various points considered has sufficient length beyond the point to develop its stress by bond. The smallest length is  $K \times$  diameter, and for the various steel stresses

TABLE XV.

| Steel stress<br>(lb. per sq. in.) | Values of $K$ |
|-----------------------------------|---------------|
| 10,000                            | 25            |
| 12,000                            | 30            |
| 14,000                            | 35            |
| 16,000                            | 40            |
| 18,000                            | 45            |

the values of  $K$  are given in *Table XV*. The values allow a bond stress of 100 lb. per square inch on bars adequately hooked at the ends. For other bond stresses (see *Table VI*) the value of  $K$  can be reduced proportionately.

ARRANGEMENT OF STEEL FOR POSITIVE MOMENTS.—A similar diagram should



beams at least 25 per cent. of the main tensile reinforcement should extend to the centre of the support before the hook or other end anchorage begins. In continuous beams at least 25 per cent. of the tensile reinforcement should be carried for a distance of at least half the effective depth beyond the points of contraflexure before a hook or other end anchorage begins.

**Girder Continuous over Two or More Supports, with Varying Moments of Inertia at each Point of the Span.**

For important bridge girders with deep haunches it is not allowable to treat the case as one with constant moments of inertia in each span, since the haunches greatly affect the values of the moments. The following general method, due to the late Mr. C. Wolff, may be used in such cases.

Let 
$$K_1 = \frac{l}{I_1}, K_2 = \frac{l}{I_2}$$

$$K_1' = \frac{l'}{I_1'}, K_2' = \frac{l'}{I_2'}$$
 and 
$$K_0 = \frac{l}{I_0}, K_0' = \frac{l'}{I_0'}$$

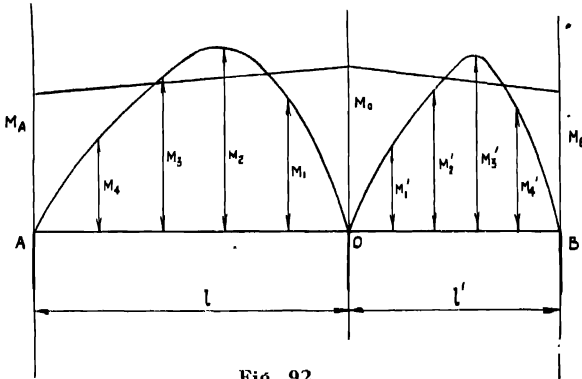

Fig. 92.

where  $I_1, I_2, \dots$  are the moments of inertia in span  $l$  and  $I_1', I_2', \dots$  in span  $l'$ .

In the diagram (Fig. 92)  $M_1, M_2, \dots, M_1', M_2', \dots$  are the "free" moments for the given loading in two adjoining spans; then the moments  $M_A, M_0$ , and  $M_B$  at the three supports are given approximately by the linear relation

$$12rM_1 + sM_0 + 12r'M_2 + 5t = 0 \quad (86)$$

where  $r = K_1 + K_2 + K_3 + K_4 \quad (87)$

$$r' = K_1' + K_2' + K_3' + K_4' \quad (88)$$

$$s = 19(K_0 + K_0') + 48(K_1 + K_1') + 18(K_2 + K_2') + 8(K_3 + K_3') + 3(K_4 + K_4') \quad (89)$$

$$t = 12(K_1M_1 + K_1'M_1') + 6(K_2M_2 + K_2'M_2') + 4(K_3M_3 + K_3'M_3') + 3(K_4M_4 + K_4'M_4') \quad (90)$$





steel. Where very great accuracy is desired the variation of steel can be allowed for by adjusting the values of  $\alpha_i$  in the formula  $\alpha b d^3$  (see Table XII).

In any span the shears can be calculated from the equations

$$S_A = \frac{1}{2}wl + \frac{(M_B - M_A)}{l} \quad \dots \quad (115)$$

$$S_B = \frac{1}{2}wl - \frac{(M_B - M_A)}{l} \quad \dots \quad (116)$$

negative values being assumed for  $M_A$  and  $M_B$ .

A special case of this problem is obtained by making  $K$  zero in the two end spans. This gives the solution for a three-span girder of varying moment of inertia built in to massive abutments at the ends (Fig. 95), the elevation of each span being symmetrical and identical for the three spans.

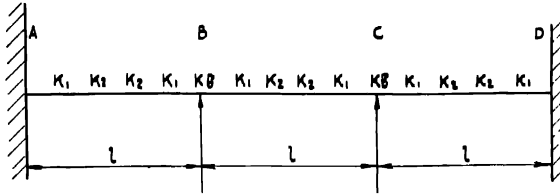

Fig. 95.

CASE 1.—Load  $w$  on  $AB$ . Let

$$a = 19K_B + 51K_1 + 26K_2 \quad \dots \quad (117)$$

$$b = 12(K_1 + K_2) \quad \dots \quad (118)$$

Then  $2am_A + 4bm_B + b = 0 \quad \dots \quad (119)$

$$4bm_A + 4am_B + 4bm_C + b = 0 \quad \dots \quad (120)$$

$$bm_B + am_C + bm_D = 0 \quad \dots \quad (121)$$

$$2bm_C + am_D = 0 \quad \dots \quad (122)$$

and  $M_A = m_A w l^2$ , etc.  $\dots \quad (123)$

CASE 2.—Load  $w$  on  $BC$ .

$$am_A + 2bm_B = 0 \quad \dots \quad (124)$$

$$4bm_A + 4(a + b)m_B + b = 0 \quad \dots \quad (125)$$

$$m_A = m_D, \quad m_B = m_C \quad \dots \quad (126)$$

and  $M_A = m_A w l^2$ , etc.  $\dots \quad (127)$

CASE 3.—Load  $w$  on  $CD$ .

$$m_A = \text{value of } m_D \text{ (Case 1)} \quad \dots \quad (128)$$

$$m_B = \text{,, } m_C \text{ ,,} \quad \dots \quad (129)$$

$$m_C = \text{,, } m_B \text{ ,,} \quad \dots \quad (130)$$

$$m_D = \text{,, } m_A \text{ ,,} \quad \dots \quad (131)$$

Then for dead load only

$$M_A = m_A w_d l^2, \text{ etc.} \quad \dots \quad (132)$$

For dead load plus live load

$$M_A = m_A (w_d + w_l) l^2 \text{ in each case} \quad \dots \quad (133)$$

By a combination of the three cases the maximum positive and negative moments may be determined.

Where the anchor spans are free cantilevers, the case is that of three equal spans, the end moments of the spans being statically determinate. The calculations are as follows.

It is assumed as before that the spans and the profiles of the three beams are identical (*Fig. 96*).

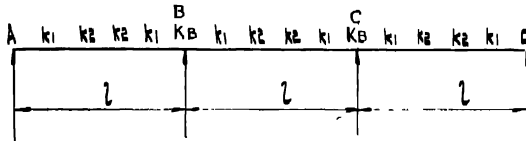

Fig. 96.

CASE 1.—Load  $w$  per linear foot on span  $AB$ .

Let  $a = (10K_B + 51K_1 + 26K_2) \dots \dots \dots (134)$

$b = 3(K_1 + K_2) \dots \dots \dots (135)$

then  $m_B = - \frac{ab}{(a^2 - 16b^2)} \dots \dots \dots (136)$

$m_C = + \frac{4b^2}{(a^2 - 16b^2)} \dots \dots \dots (137)$

and  $M_B = m_B wl^2, M_C = m_C wl^2 \dots \dots \dots (138)$

CASE 2.—Load  $w$  per linear foot on span  $BC$ .

$m_B = m_C = - \frac{b}{(a + 4b)} \dots \dots \dots (139)$

CASE 3.—Load  $w$  per linear foot on span  $CD$ .

$m_B = + \frac{4b^2}{(a^2 - 16b^2)} \dots \dots \dots (140)$

$m_C = - \frac{ab}{(a^2 - 16b^2)} \dots \dots \dots (141)$

In the case where there is a cantilever span beyond  $A$ , giving a moment  $M_A$  at  $A$  which can be determined statically,

$M_B = - \frac{4ab}{a^2 - 16b^2} M_A \dots \dots \dots (142)$

$M_C = \frac{16b^2}{a^2 - 16b^2} M_A \dots \dots \dots (143)$

Where there is a cantilever span at  $D$ , giving a moment  $M_D$ ,

$M_B = \frac{16b^2}{a^2 - 16b^2} M_D \dots \dots \dots (144)$

$M_C = - \frac{4ab}{a^2 - 16b^2} M_D \dots \dots \dots (145)$

These equations are sufficient to determine the moments with any length of cantilever arms.



**Single-span Girder built in at Ends with Varying Moments of Inertia.**

Cases of single-span girders built into massive abutments at both ends sometimes occur in which the end fixation may be regarded as perfect. The formulæ are then as follows.

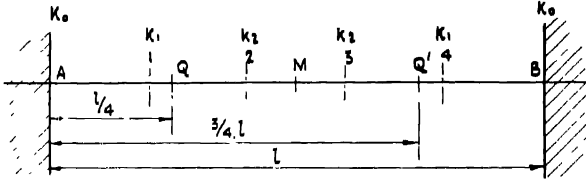

Fig. 97.

(a) UNIFORMLY DISTRIBUTED LOADING  $w$  PER LINEAR FOOT.

Here  $K_0 = \frac{l}{I_0}$ ,  $K_1 = \frac{l}{I_1}$ ,  $K_2 = \frac{l}{I_2}$ , and the girder is assumed to be symmetrical (Fig. 97).

$$M_A = M_B = - \frac{6(K_1 + K_2)}{(19K_0 + 75K_1 + 50K_2)} w l^2 \tag{146}$$

$$M_{\max} = \frac{w l^2}{8} + M_A \text{ (negative)} \tag{147}$$

(b) CONCENTRATED LOADS.

Load at point Q, the quarter-point in the span.

$$M_A = - \frac{(ac - b)}{(a^2 - 1)} W l \tag{148}$$

$$M_B = - \frac{(ab - c)}{(a^2 - 1)} W l \tag{149}$$

where

$$a = \frac{(19K_0 + 51K_1 + 26K_2)}{24(K_1 + K_2)} \tag{150}$$

$$b = \frac{21K_1 + 24K_2}{96(K_1 + K_2)} \tag{151}$$

$$c = \frac{39K_1 + 26K_2}{96(K_1 + K_2)} \tag{152}$$

Load at point M, the middle of the span.

$$M_A = M_B = - \frac{30K_1 + 40K_2}{4(19K_0 + 75K_1 + 50K_2)} W l \tag{153}$$

$$M_{\max} = \frac{w l^2}{8} + M_A \text{ (negative)} \tag{153'}$$

These results for concentrated loads are not such close approximations as for

distributed loading, the maximum error being about 5 per cent. in the cases examined, but are sufficiently exact for practical purposes.

Load at quarter-point  $Q'$ .

$$M_A = M_B \text{ [formula (149)] and } M_B = M_A \text{ [formula (148)]}$$

These values are sufficient to enable the influence lines to be drawn, remembering that in the case of  $M_A$  the slope of the tangent line at  $A$  is given by  $\tan \theta$  equals  $W$  and that the curve must touch the base-line at  $B$  (Fig. 98). In fact  $M_A$  can be assumed of the form

$$M_A = x(l-x)^2[a + b(l-x) + c(l-x)^2 + d(l-x)^3] \quad (154)$$

the values of  $a, b, c,$  and  $d$  being determined from the values of  $M_1, M_{1/2}, M_{3/4}$  corresponding to  $x = \frac{1}{4}, \frac{1}{2},$  and  $\frac{3}{4}$  with the further condition

$$(a + bl + cl^2 + dl^3)l^2 = W \quad (155)$$

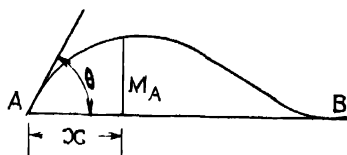

Fig. 98.

these giving four linear equations to determine  $a, b, c,$  and  $d$ .

The influence line for  $M_B$  is, of course, the image of the curve for  $M_A$ , and the "free" moment diagram is a parabola with a rise equal to  $\frac{Wl}{4}$ . From these

three curves the moments at any points can be determined for any distribution of loading; a variable distributed loading, for example, can be replaced by corresponding point loads acting at regular intervals of the span. Usually, however, it is sufficient to calculate by means of equations (146), (147), (153), and (153') for a uniformly-distributed load plus a "knife-edge" load assumed acting at the centre of the span.

### Continuous Girders with Fixed Contraflexure Points.

The calculation of continuous lines of girders can be made exactly and reduced to static equations by the introduction of hinges at chosen points (Fig. 99).

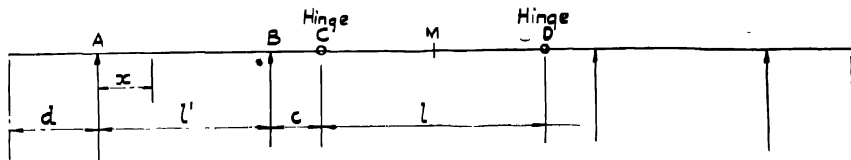

Fig. 99.

With regard to the position of such hinges no definite rules can be laid down, but they will usually be placed at distances of one-fifth to one-third of the spans measured from the supports. In cases of arched girders where the headroom

is limited, consideration of the middle freely-supported spans will be the determining factor so as not to exceed the resistance moments for the pre-determined depth.

The method of calculation is very simple, and can be illustrated by the following example. In this case the end of the bridge is at a distance  $d$  to the left of  $A$ .

(a) DISTRIBUTED LOAD.— $w_d$  = dead load per linear foot.  $w_l$  = live load per linear foot.

Maximum moment on span  $CD$ ,  $M_m = \frac{1}{8}(w_d + w_l)l^2$  . . . . . (156)

Maximum negative moment at  $B$ ,  $M_B = -\frac{1}{2}(w_d + w_l)c(l + c)$  . . . . . (157)

Minimum " " "  $B$ ,  $M_B' = -\frac{1}{2}w_dc(l + c)$  . . . . . (158)

Maximum negative moment at  $A$ ,  $M_A = -\frac{1}{2}(w_d + w_l)d^2$  . . . . . (159)

Minimum " " "  $A$ ,  $M_A' = -\frac{1}{2}w_d d^2$  . . . . . (160)

Maximum moments on span  $AB$

$$M_x = \frac{1}{2}(w_d + w_l)x(l' - x) + M_A' + \frac{x}{l'}(M_B' - M_A') \quad . \quad . \quad . \quad (161)$$

Minimum moments on span  $AB$

$$M_x = \frac{1}{2}w_dx(l' - x) + M_A + \frac{x}{l'}(M_B - M_A) \quad . \quad . \quad . \quad (162)$$

Maximum shear at  $A$  on span  $l'$

$$S_A = \frac{1}{2}(w_d + w_l)l' - \frac{(M_A - M_B')}{l'} \quad . \quad . \quad . \quad (163)$$

$$S_B = \frac{1}{2}(w_d + w_l)l' + \frac{(M_A' - M_B)}{l'} \quad . \quad . \quad . \quad (164)$$

(b) SINGLE KNIFE-EDGE LOAD  $W$  :

Maximum moment on span  $CD$ ,  $M_m = \frac{1}{4}Wl$  . . . . . (165)

Maximum negative moment at  $B$ ,  $M_B = -Wc$  . . . . . (166)

Maximum positive moments on span  $AB$   $M_x = \frac{Wx(l' - x)}{l'}$  . . . . . (167)

Maximum negative moments on span  $AB$ ,  $M_x = -\frac{Wcx}{l'}$  . . . . . (168)

or  $M_x = -\frac{Wd(l' - x)}{l'}$  . . . . . (169)

Maximum negative moment at  $A$ ,  $M_A = -Wd$  . . . . . (170)

**Design of Hinges.**

The only difficulty in the design of girders of this type is in connection with the hinges, for here one-half of the depth of the girder must be cut away and the shearing stress may be high. There should be sufficient diagonal steel cranked down from the cantilever arms and passing under the rest of the freely-supported span to resist the entire shear, and special attention should be given to the security of such bars in bond. Since at this hinge or contraflexure point, in cantilever and suspended span construction, the expansion of the structure is allowed for, a

sliding-plate type of bearing is usually provided owing to the small space available. For the expansion joint to operate freely there must be a free joint right across the bridge on the line of the contraflexure points, that is through the deck slab and parapets as well as through the girders. It is a matter of opinion whether the joint in the parapet should be marked or not. It is, however, important that, whatever treatment or filling is applied to the transverse joint in any part of the structure, freedom from restraint should be ensured.

**Example.—Continuous Span Girders (Fig. 100) with (1) constant moments of inertia, and (2) varying moments of inertia.**

As an example the following will be considered: Five-span girder, two end spans  $l_1 = 36$  ft., three interior spans  $l_2 = 87$  ft. Distance between girders = 7 ft.; deck slab  $8\frac{1}{2}$  in. thick, total dead load on end spans 3290 lb. per linear foot; on interior spans 2600 lb. per linear foot. Live load 276 lb. per square foot distributed.

CASE I.—UNIFORM DEPTH OF T-BEAM GIRDERS, A CONSTANT MOMENT OF INERTIA BEING ASSUMED (Fig. 101).

Dead load ( $w_d$ ) (decking, finish, and self weight)

$$\begin{aligned} & \text{for end spans} = 3290 \text{ lb per foot.} \\ \text{Dead load for interior spans} & = 2600 \text{ " " " " } \\ \text{Live loading } 7 \times 276 = w_l & = 1932 \text{ " " " " } \end{aligned}$$

With load on span  $AB$ .—

(Assuming a uniform moment of inertia throughout, equations (96) to (99) reduce to

$$8m_B(\alpha + 1) + 4m_C + \alpha = 0 \text{ where } \frac{l_1}{l_2} = \alpha = \frac{36}{87} = 0.414$$

$$m_B + 4m_C + m_D = 0$$

$$m_C + 4m_D + m_E = 0$$

$$m_D + 2(\alpha + 1)m_E = 0$$

giving  $m_B = -0.0404$ ,  $m_C = +0.0109$ ,  $m_D = -0.0030$ , and  $m_E = +0.0010$ .

The bending moments are then:

Dead Load.

$$\text{At } B, M_d = -36^2 \times 3290 \times 0.0404 \times 12 = -2,060,000 \text{ in. lb.}$$

$$C, M_d = +36^2 \times 3290 \times 0.0109 \times 12 = +556,000 \text{ "}$$

$$D, M_d = -36^2 \times 3290 \times 0.0030 \times 12 = -153,000 \text{ "}$$

$$E, M_d = +36^2 \times 3290 \times 0.0010 \times 12 = +51,100 \text{ "}$$

Live Load.

$$\text{At } B, M_l = -36^2 \times 1932 \times 0.0404 \times 12 = -1,210,000 \text{ "}$$

$$C, M_l = +36^2 \times 1932 \times 0.0109 \times 12 = +326,000 \text{ "}$$

$$D, M_l = -36^2 \times 1932 \times 0.0030 \times 12 = -90,000 \text{ "}$$

$$E, M_l = +36^2 \times 1932 \times 0.0010 \times 12 = +30,000 \text{ "}$$

"Free" Moment:

$$M_d = +36^2 \times 3290 \times 1.5 = +6,400,000 \text{ in. lb.}$$

$$M = +36^2 \times 1932 \times 1.5 = +3,750,000 \text{ "}$$

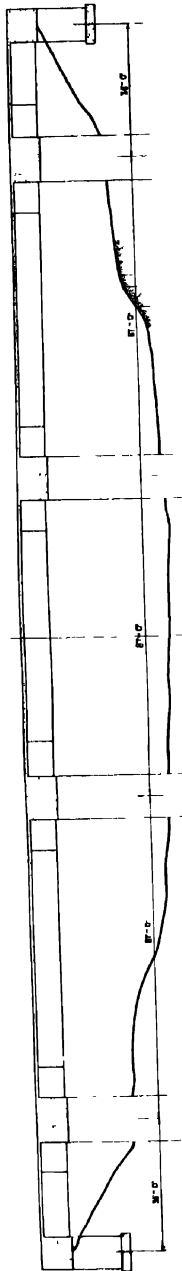

LONGITUDINAL SECTION  
CASE I.

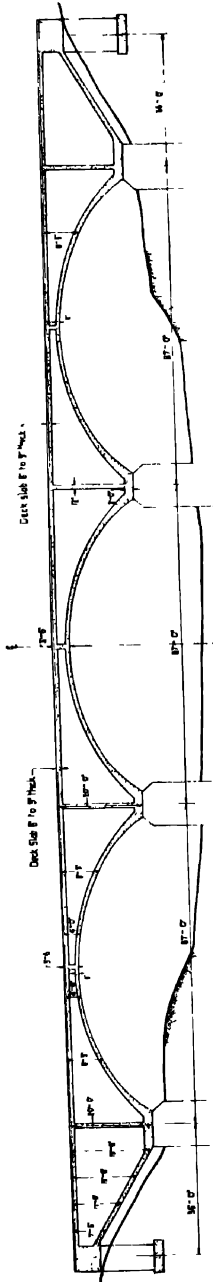

LONGITUDINAL SECTION  
CASE II.

Fig. 100.

With load on span *BC*.—

Equations 100 to 103, with  $\alpha = 0.414$ , become :

$$8(1 + \alpha)m_B + 4m_C + 1 = 0$$

$$4m_B + 16m_C + 4m_D + 1 = 0$$

$$m_C + 4m_D + m_E = 0$$

$$m_D + 2(1 + \alpha)m_B = 0$$

Then  $m_B = -0.0713$ ,  $m_C = -0.0480$ ,  $m_D = +0.0132$ , and  $m_E = -0.0047$ .

The bending moments are :

Dead Load.

$$\text{At } B, M_d = -87^2 \times 2600 \times 0.0713 \times 12 = -16,800,000 \text{ in. lb.}$$

$$C, M_d = -87^2 \times 2600 \times 0.0480 \times 12 = -11,320,000 \text{ ,,}$$

$$D, M_d = +87^2 \times 2600 \times 0.0132 \times 12 = +3,110,000 \text{ ,,}$$

$$E, M_d = -87^2 \times 2600 \times 0.0047 \times 12 = -1,110,000 \text{ ,,}$$

Live Load.

$$\text{At } B, M_l = -87^2 \times 1932 \times 0.0713 \times 12 = -12,500,000 \text{ ,,}$$

$$C, M_l = -87^2 \times 1932 \times 0.0480 \times 12 = -8,410,000 \text{ ,,}$$

$$D, M_l = +87^2 \times 1932 \times 0.0132 \times 12 = +2,320,000 \text{ ,,}$$

$$E, M_l = -87^2 \times 1932 \times 0.0047 \times 12 = -825,000 \text{ ,,}$$

“ Free ” Moment :

$$M_d = 87^2 \times 2600 \times 1.5 = +29,500,000 \text{ in. lb.}$$

$$M_l = 87^2 \times 1932 \times 1.5 = +21,900,000 \text{ ,,}$$

With load on span *CD*.—

Equations (108) and (109) reduce to :

$$2(1 + \alpha)m_B + m_C = 0$$

$$4m_B + 20m_C + 1 = 0$$

$$\therefore m_B = +0.0190, \text{ and } m_C = -0.0538.$$

The bending moments are :

Dead Load.

$$\text{At } B \text{ and } E, M_d = +87^2 \times 2600 \times 0.0190 \times 12 = +4,500,000 \text{ in. lb.}$$

$$C \text{ and } D, M_d = -87^2 \times 2600 \times 0.0538 \times 12 = -12,750,000 \text{ ,,}$$

Live Load.

$$\text{At } B \text{ and } E, M_l = +87^2 \times 1932 \times 0.0190 \times 12 = +3,340,000 \text{ ,,}$$

$$C \text{ and } D, M_l = -87^2 \times 1932 \times 0.0538 \times 12 = -9,450,000 \text{ ,,}$$

“ Free ” Moment :

$$M_d = 87^2 \times 2600 \times 1.5 = 29,500,000 \text{ in. lb.}$$

$$M_l = 87^2 \times 1932 \times 1.5 = 21,900,000 \text{ ,,}$$

Resultant Dead-Load Moments with all Spans Loaded.—Combining these results the resultant dead-load bending moments are :

$$\text{At } B \text{ or } E, M_B = -2,060,000 - 16,800,000 + 4,500,000 - 1,110,000 + 51,100 \\ = -15,419,000 \text{ in. lb.}$$

$$\text{At } C \text{ or } D, M_C = +556,000 - 11,320,000 - 12,750,000 + 3,100,000 - 153,000 \\ = -20,557,000 \text{ in. lb.}$$

The “ free ” moments are :

$$\text{In spans } AB \text{ and } EF, M_d = +6,400,000 \text{ in. lb.}$$

$$\text{,, ,, } BC, CD, \text{ and } DE, M_d = +29,500,000 \text{ ,,}$$

Maximum Negative Moments due to Live Loading.—

(1) At *B* (or *E*), spans *AB*, *BC*, and *DE* being loaded,

$M_B = - 1,210,000 - 12,500,000 - 825,000 = - 14,535,000$  in. lb.,  
with a corresponding value

$$M_C = + 326,000 - 8,410,000 + 2,320,000 = - 5,764,000 \text{ in. lb.}$$

and "free" moments  $M_i = + 3,750,000$  in. lb. in span *AB*

$$M_i = + 21,900,000 \quad \text{,,} \quad \text{,,} \quad \text{,,} \quad \text{BC.}$$

(2) At *C* (or *D*), spans *BC*, *CD*, and *EF* being loaded,

$M_C = - 8,410,000 - 9,450,000 - 90,000 = - 17,950,000$  in. lb.,  
with corresponding values

$$M_D = + 2,320,000 - 9,450,000 + 326,000 = - 6,804,000 \text{ in. lb.}$$

$$M_B = - 12,500,000 + 3,340,000 + 30,000 = - 9,130,000 \quad \text{,,}$$

and "free" moments  $M_i = + 21,900,000$  in. lb. in spans *BC* and *CD*.

Maximum Positive Moments due to Live Loading.—

(1) In span *AB* with *AB*, *CD*, and *EF* loaded,

$$M_B = - 1,210,000 + 3,340,000 + 30,000 = + 2,160,000 \text{ in. lb.}$$

and the "free" moment is  $+ 3,750,000$  in. lb. The maximum positive moment can then be found graphically.

(2) In span *BC* with *BC* and *DE* loaded,

$$M_B = - 12,500,000 - 825,000 = - 13,325,000 \text{ in. lb.},$$

and  $M_C = - 8,410,000 + 2,320,000 = - 6,090,000 \quad \text{,,}$

The "free" moment  $M_i = + 21,900,000$  in. lb., and the maximum positive moment can be found graphically.

(3) In span *CD* with *AB*, *CD*, and *EF* loaded,

$$M_C = M_D = + 326,000 - 9,450,000 - 90,000 = - 9,214,000 \text{ in. lb.}$$

The maximum positive moment

$$M_{108} = 21,900,000 - 9,214,000 = + 12,686,000 \text{ in. lb.}$$

Maximum Negative Moments due to Dead Load plus Live Load.—

(1) At *B* (or *E*),

$$M_B = - 15,419,000 - 14,535,000 = - 29,954,000 \text{ in. lb.}$$

with  $M_C = - 20,557,000 - 5,764,000 = - 26,321,000 \quad \text{,,}$

"Free" moment:  $M_{AB} = 6,400,000 + 3,750,000 = + 10,150,000$  in. lb.

"Free" moment:  $M_{BC} = 29,500,000 + 21,900,000 = + 51,400,000 \quad \text{,,}$

(2) At *C* (or *D*),

$$M_C = - 20,557,000 - 17,950,000 = - 38,507,000 \text{ in. lb.}$$

with  $M_B = - 15,419,000 - 9,130,000 = - 24,549,000 \quad \text{,,}$

and  $M_D = - 20,557,000 - 6,804,000 = - 27,461,000 \quad \text{,,}$

The "free" moment  $M_{BC} = M_{CD} = + 51,400,000$  in. lb.

(1) In span *AB*:

"Free" moment  $= 6,400,000 + 3,750,000 = + 10,150,000$  in. lb., and

$$M_B = - 15,419,000 + 2,160,000 = - 13,259,000 \text{ in. lb.}$$

From diagram (*Fig. 102*)  $M_{\max} = + 4,600,000$  in. lb.







$$\text{At } B \text{ (on right) } S_t = \frac{1}{2} \times 87 \times 1932 = + 84,000$$

$$+ \frac{(14,535,000 - 5,764,000)}{87 \times 12} = + 92,400 \text{ lb.}$$

$$- 8400'$$

$$\text{At } B \text{ (on left) } S_t = = - 34,800$$

$$\frac{14,535,000}{36 \times 12} = - 35,500 = - 70,300 \text{ lb.}$$

$$\text{At } C \text{ (on left) } S_t = = - 84,000$$

$$\frac{(17,950,000 - 9,130,000)}{87 \times 12} = - 92,450 \text{ lb.}$$

$$= - 8450$$

$$\text{At } C \text{ (on right) } S_t = = + 84,000$$

$$+ \frac{(17,950,000 - 6,804,000)}{87 \times 12} = + 94,650 \text{ lb.}$$

$$= + 10,650'$$

Combined Shears due to Dead Load plus Live Load.—

$$\text{At } A \begin{cases} S = 23,500 + 39,800 = + 63,300 \text{ lb. (maximum)} \\ S = 23,500 - 48,100 = - 24,600 \text{ ,, (minimum).} \end{cases}$$

$$\text{At } B \text{ (left), } S = - 94,900 - 70,300 = - 165,200 \text{ lb.}$$

$$\text{At } B \text{ (right), } S = 107,330 + 92,400 = + 199,730 \text{ lb.}$$

$$\text{At } C \text{ (left), } S = - 118,670 - 92,450 = - 211,120 \text{ lb.}$$

$$\text{At } C \text{ (right), } S = 113,000 + 94,650 = + 207,650 \text{ lb.}$$

CASE 2.—In order to illustrate the effect of a wide variation in depths of a girder and the error involved in assuming constant moments of inertia, a five-span girder will be considered with the spans equal to those in the case just considered, particulars being as follows (Fig. 103):

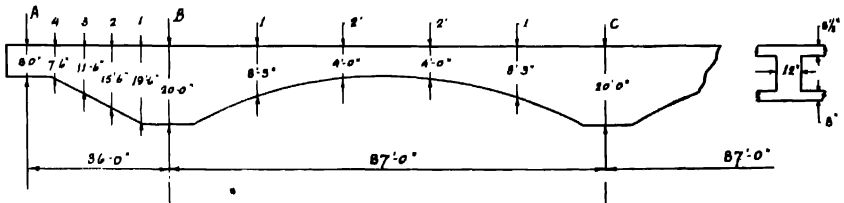

Fig. 103.

Two end spans,  $l_1 = 36$  ft. Three interior spans,  $l_2 = 87$  ft. Soffit slab connecting ribs 8 in. minimum at crown. Depths of end and interior girders as shown, all interior and both end girders being identical. Distance between girders = 7 ft. Average thickness of deck slab =  $8\frac{1}{2}$  in. Finish, tarmacadam, 2 in. thick. Live load 276 lb. per square foot. Depth of girders at midspan, 3 ft. 6 in.

Dead Load on 87-ft. Span.—

|                                   |                                   |   |
|-----------------------------------|-----------------------------------|---|
| Total decking on main span        | $87 \times 6 \times 104 = 54,400$ | Average dead load per linear                    |
| 2 in. tarmacadam                  | $87 \times 7 \times 20 = 12,200$  | foot  |
| Self weight                       |                                   | $= \frac{266,670}{87} = 2600 \text{ lb.} = w$ . |
| 3.5 ft. to 20 ft. $\times$ 12 in. | $= 710 \times 144 = 102,500$      |   |
| Soffit slab, average,             | $98 \times 6 \times 164 = 96,300$ | Live loading per linear foot                    |
| Cross beam at crown               | $6 \times 2.2 \times 96 = 1,270$  | $= 7 \times 276 = 1932 \text{ lb.} = w_1$ .     |
|                                   | $266,670$                         |   |

Dead Load on 36-ft. Span.—

|                            |                                   |   |
|----------------------------|-----------------------------------|---|
| Total decking on main span | $36 \times 6 \times 104 = 22,500$ | Average dead loading per                          |
| 2 in. tarmacadam           | $36 \times 7 \times 20 = 5040$    | linear foot                                       |
| Self weight                | $469 \times 144 = 67,500$         | $= \frac{118,640}{36} = 3290 \text{ lb.} = w_d$ . |
| Soffit slab                | $96 \times 6 \times 41 = 23,600$  |   |
|                            | $118,640$                         |   |

Since these are continuous slabs connecting the ribs at top and bottom the values of  $I$  will be taken as varying proportional to depth<sup>3</sup>. Such a variation could be ensured in any particular case by correctly varying the thickness of the soffit slab, or alternatively a lower power can be assumed.

Taking the values of  $K$  at point 2' as unity, the values of  $K$ , etc., at the various points are

$$\left. \begin{aligned} K_1 &= \frac{36}{87} \times \left(\frac{4}{19.5}\right)^3, & K_B &= \frac{36}{87} \times \left(\frac{4}{20}\right)^3, & a_1 &= 32.65 \\ K_2 &= \frac{36}{87} \times \left(\frac{4}{15.5}\right)^3, & K_B' &= \left(\frac{4}{20}\right)^3, & a_2 &= 31.95 \\ K_3 &= \frac{36}{87} \times \left(\frac{4}{11.5}\right)^3, & K_1' &= \left(\frac{4}{8.25}\right)^3, & b &= 13.37 \\ K_4 &= \frac{36}{87} \times \left(\frac{4}{7.5}\right)^3, & K_2' &= 1, & c &= 0.1606 \end{aligned} \right\} \begin{array}{l} \text{from equations (92),} \\ \text{(93), and (94).} \end{array}$$

Load on Span  $AB$ .—

Equations (96) to (99) become

$$\begin{aligned} 203.2 m_B + 166.5 m_C + 1 &= 0 \\ m_B + 2.39 m_C + m_D &= 0 \\ m_C + 2.39 m_D + m_E &= 0 \\ 0.819 m_D + m_E &= 0 \end{aligned}$$

$$\therefore m_B = -0.0094, m_C = +0.0054, m_D = -0.0034, \text{ and } m_E = +0.0028.$$

The bending moments are

Dead Load.

$$\begin{aligned} \text{At } B, M_d &= -36^2 \times 3290 \times 0.0094 \times 12 = -481,000 \text{ in. lb.} \\ C, M_d &= +36^2 \times 3290 \times 0.0054 \times 12 = +276,000 \text{ ,,} \\ D, M_d &= -36^2 \times 3290 \times 0.0034 \times 12 = -174,000 \text{ ,,} \\ E, M_d &= +36^2 \times 3290 \times 0.0028 \times 12 = +143,000 \text{ ,,} \end{aligned}$$

Live Load.

$$\begin{aligned} \text{At } B, M_l &= -36^2 \times 1932 \times 0.0094 \times 12 = -282,000 \text{ in. lb.} \\ C, M_l &= +36^2 \times 1932 \times 0.0054 \times 12 = +162,000 \text{ ,,} \\ D, M_l &= -36^2 \times 1932 \times 0.0034 \times 12 = -102,000 \text{ ,,} \\ E, M_l &= +36^2 \times 1932 \times 0.0028 \times 12 = +84,000 \text{ ,,} \end{aligned}$$

The "free" moments are

$$\begin{aligned} M_d &= +36^2 \times 3290 \times 1.5 = 6,400,000 \text{ in. lb.} \\ M_l &= +36^2 \times 1932 \times 1.5 = 3,750,000 \text{ ,,} \end{aligned}$$

Load on Span *BC*.—

Equations (100) to (103) become

$$\begin{aligned} 4.885 m_B + 4 m_C + 1 &= 0 \\ 4 m_B + 9.56 m_C + 4 m_D + 1 &= 0 \\ m_C + 2.39 m_D + m_E &= 0 \\ 0.819 m_D + m_E &= 0 \end{aligned}$$

giving  $m_B = -0.1650$ ,  $m_C = -0.0485$ ,  $m_D = +0.0308$ , and  $m_E = -0.0252$ .

The moments are then

Dead Load.

$$\begin{aligned} \text{At } B, M_d &= -87^2 \times 2600 \times 12 \times 0.1650 = -38,900,000 \text{ in. lb.} \\ C, M_d &= -87^2 \times 2600 \times 12 \times 0.0485 = 11,450,000 \text{ ,,} \\ D, M_d &= +87^2 \times 2600 \times 12 \times 0.0308 = +7,260,000 \text{ ,,} \\ E, M_d &= -87^2 \times 2600 \times 12 \times 0.0252 = -5,940,000 \text{ ,,} \end{aligned}$$

Live Load.

$$\begin{aligned} \text{At } B, M_l &= -87^2 \times 1932 \times 12 \times 0.1650 = -28,900,000 \text{ in. lb.} \\ C, M_l &= -87^2 \times 1932 \times 12 \times 0.0485 = 8,500,000 \text{ ,,} \\ D, M_l &= +87^2 \times 1932 \times 12 \times 0.0308 = +5,400,000 \text{ ,,} \\ E, M_l &= -87^2 \times 1932 \times 12 \times 0.0252 = -4,410,000 \text{ ,,} \end{aligned}$$

The "free" moments are

$$\begin{aligned} M_d &= 87^2 \times 2600 \times 1.5 = +29,500,000 \text{ in. lb.} \\ M_l &= 87^2 \times 1932 \times 1.5 = +21,900,000 \text{ ,,} \end{aligned}$$

Load on Span *CD*.—

Equations (108) and (109) become

$$\begin{aligned} 1.22 m_B + m_C &= 0 \\ 4 m_B + 13.55 m_C + 1 &= 0 \end{aligned}$$

giving  $m_B = m_E = +0.0798$ , and  $m_C = m_D = -0.0974$ .

The moments are then

Dead Load.

$$\begin{aligned} \text{At } B \text{ and } E, M_d &= +87^2 \times 2600 \times 12 \times 0.0798 = +18,850,000 \text{ in. lb.} \\ C \text{ and } D, M_d &= -87^2 \times 2600 \times 12 \times 0.0974 = -23,000,000 \text{ ,,} \end{aligned}$$

Live Load.

$$\begin{aligned} \text{At } B \text{ and } E, M_l &= +87^2 \times 1932 \times 12 \times 0.0798 = +14,000,000 \text{ in. lb.} \\ C \text{ and } D, M_l &= -87^2 \times 1932 \times 12 \times 0.0974 = -17,100,000 \text{ ,,} \end{aligned}$$

The "free" moments are, as before,

$$\begin{aligned} M_d &= +29,500,000 \text{ in. lb.} \\ M_l &= +21,900,000 \text{ ,,} \end{aligned}$$

Resultant Dead-Load Moments with all Spans Loaded.—

Combining these results the resultant dead-load moments are :

$$\text{At } B \text{ and } E, M_d = -481,000 - 38,900,000 + 18,850,000 - 5,940,000 + 143,000 \\ = -26,328,000 \text{ in. lb.}$$

$$\text{At } C \text{ and } D, M_d = 276,000 - 11,450,000 + 7,260,000 - 174,000 - 23,000,000 \\ = -27,088,000 \text{ in. lb.}$$

The "free" moments are :

$$\text{In spans } AB \text{ and } EF, M_d = \frac{1}{2} 6,400,000 \text{ in. lb.}$$

$$,, ,, BC, CD \text{ and } DE, M_d = +29,500,000 ,,$$

Maximum Negative Moments due to Live Load.—

(1) At *B* (or *E*) spans *AB*, *BC*, and *DE* loaded.

$$M_B = -282,000 - 28,900,000 - 4,410,000 = -33,592,000 \text{ in. lb.}$$

with a corresponding value

$$M_C = +162,000 - 8,500,000 + 5,400,000 = -2,938,000 \text{ in. lb.}$$

and "free" moments  $M_l = +3,750,000$  in. lb. in span *AB*

$$M_l = +21,900,000 ,, ,, BC.$$

(2) At *C* (or *D*) spans *BC*, *CD*, and *EF* loaded.

$$M_C = -8,500,000 - 17,100,000 - 102,000 = -25,702,000 \text{ in. lb.}$$

with corresponding values

$$M_B = -28,900,000 + 14,000,000 + 84,000 = -14,816,000 \text{ in. lb.}$$

$$M_D = +5,400,000 - 17,100,000 + 162,000 = -11,538,000 ,,$$

and "free" moments  $M_l = +21,900,000$  in. lb. in spans *BC* and *CD*.

Maximum Positive Moments due to Live Load.—

(1) In span *AB* with *AB*, *CD*, and *EF* loaded.

$$M_B = -282,000 + 14,000,000 + 84,000 = +13,802,000 \text{ in. lb.}$$

$$\text{"Free" moment } M_l = +3,750,000 \text{ in. lb.}$$

The maximum positive moment can then be found graphically.

(2) In span *BC* with *BC* and *DE* loaded.

$$M_B = -28,900,000 - 4,410,000 = -33,310,000 \text{ in. lb.}$$

$$M_C = -8,500,000 + 5,400,000 = -3,100,000 ,,$$

$$\text{"Free" moment } M_l = +21,900,000 \text{ in. lb.}$$

The maximum positive moment can be found graphically.

(3) In span *CD* with *AB*, *CD*, and *EF* loaded.

$$M_C = M_D = +162,000 - 17,100,000 - 102,000 = -17,040,000 \text{ in. lb.}$$

The maximum positive moment is

$$M_{\text{pos.}} = 21,900,000 - 17,040,000 = +4,860,000 \text{ in. lb.}$$

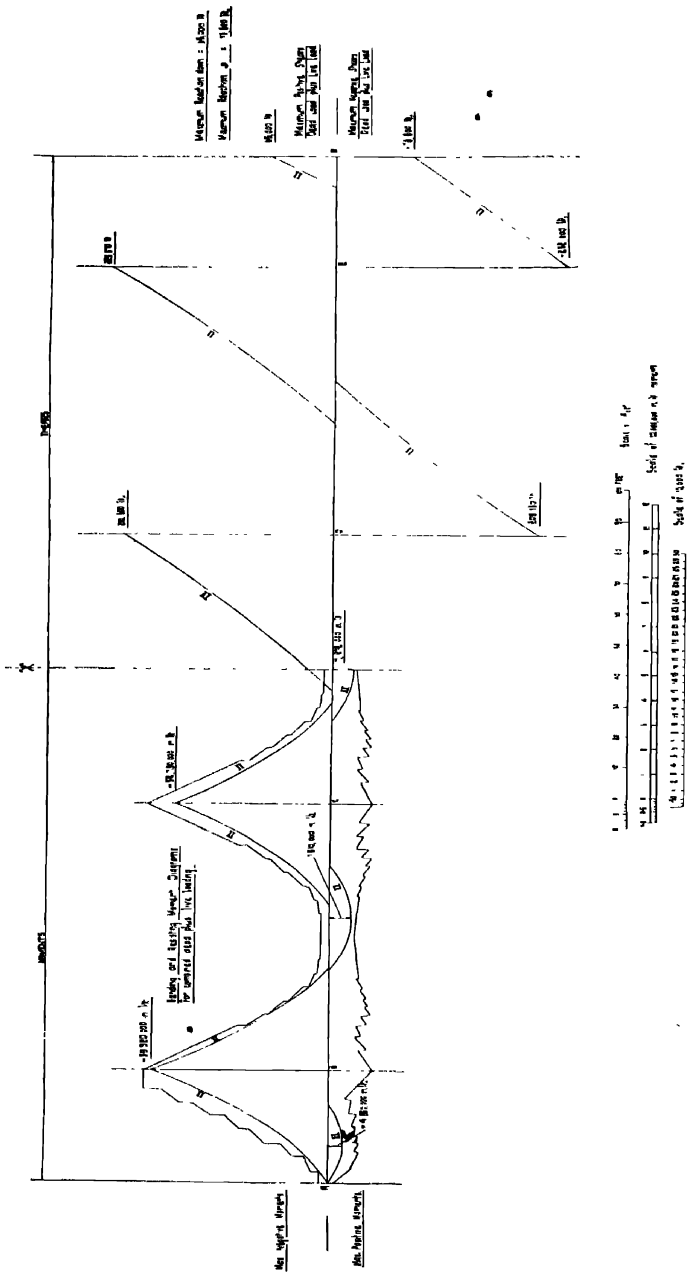

Maximum Negative Moment due to Dead Load plus Live Load.—

(1) At *B* (or *E*).

$$M_B = -26,328,000 - 33,592,000 = -59,920,000 \text{ in. lb.}$$

with  $M_C = -27,088,000 - 2,938,000 = -30,026,000 \text{ ,,}$

$$M_{AB} = +6,400,000 + 3,750,000 = +10,150,000 \text{ (" free " moment)}$$

$$M_{BC} = +29,500,000 + 21,900,000 = +51,400,000 \text{ (" free " moment).}$$

(2) At *C* (or *D*).

$$M_C = -27,088,000 - 25,702,000 = -52,790,000 \text{ in. lb.}$$

with  $M_B = -26,328,000 - 14,816,000 = -41,144,000 \text{ ,,}$

and  $M_D = -27,088,000 - 11,538,000 = -38,626,000 \text{ ,,}$

" Free " moments  $M_{BC} = M_{CD} = +51,400,000 \text{ ,,}$

Maximum Positive Moments due to Dead Load plus Live Load.—

(1) In span *AB*.

" Free " moment  $M_{AB} = +6,400,000 + 3,750,000 = +10,150,000 \text{ in. lb.}$

$$M_B = -26,328,000 + 13,802,000 = -12,526,000 \text{ ,,}$$

From diagram (*Fig. 104*)  $M_{\max.} = +4,850,000 \text{ in. lb.}$

(2) In span *BC*.

" Free " moment  $M_{BC} = +29,500,000 + 21,900,000 = +51,400,000 \text{ in. lb.}$

$$M_B = -26,328,000 - 33,310,000 = -59,638,000 \text{ ,,}$$

$$M_C = -27,088,000 - 3,100,000 = -30,188,000 \text{ ,,}$$

From diagram (*Fig. 104*)  $M_{\max.} = +7,510,000 \text{ in. lb.}$

(3) In span *CD*.

" Free " moment  $M_{CD} = +29,500,000 + 21,900,000 = +51,400,000 \text{ in. lb.}$

$$M_C = M_D = -27,088,000 - 17,040,000 = -44,128,000 \text{ ,,}$$

From diagram  $M_{\max.} = +7,272,000 \text{ in. lb.}$

Shears.—

(I) Dead Load Shears.

At *A*,  $S_d = \frac{1}{2} \times 36 \times 3290 = +59,200$

$$- \frac{26,328,000}{36 \times 12} = -61,000 \left. \vphantom{\frac{1}{2} \times 36 \times 3290} \right\} -1800 \text{ lb.}$$

At *B* (on right),  $S_d = \frac{1}{2} \times 87 \times 2600 = +113,000$

$$+ \frac{(26,328,000 - 27,088,000)}{87 \times 12} = -730 \left. \vphantom{\frac{1}{2} \times 87 \times 2600} \right\} +112,270 \text{ lb.}$$

At *B* (on left),  $S_d = -59,200 - 61,000 = -120,200 \text{ lb.}$

At *C* (on left),  $S_d = -113,000 - 730 = -113,730 \text{ ,,}$

At *C* (on right),  $S_d = +113,000 \text{ ,,}$

(II) Live Load Shears.

At *A*,  $S_l = \frac{1}{2} \times 36 \times 1932 = 34,800$

$$+ \frac{13,802,000}{36 \times 12} = 32,000 \left. \vphantom{\frac{1}{2} \times 36 \times 1932} \right\} 66,800 \text{ lb. (maximum)}$$

and  $S_l = -\frac{33,592,000}{36 \times 12} = -77,800 \text{ lb. (minimum).}$

$$\text{At } B \text{ (on right), } S_t = \left. \begin{aligned} &-\frac{1}{2} \times 87 \times 1932 = + 84,000 \\ &+ \frac{(33,592,000 - 2,938,000)}{87 \times 12} \\ &= + 29,300 \end{aligned} \right\} 113,300 \text{ lb.}$$

$$\text{At } B \text{ (on left), } S_t = \left. \begin{aligned} &-\frac{1}{2} \times 36 \times 1932 = - 34,800 \\ &\frac{33,592,000}{36 \times 12} = - 77,600 \end{aligned} \right\} 112,400 \text{ lb.}$$

$$\text{At } C \text{ (on left), } S_t = \begin{aligned} &- 84,000 \\ &- \frac{(25,702,000 - 14,816,000)}{87 \times 12} = - 94,400 \text{ lb.} \\ &= - 10,400 \end{aligned}$$

$$\text{At } C \text{ (on right), } S_t = \begin{aligned} &+ 84,000 \\ &+ \frac{(25,702,000 - 11,538,000)}{87 \times 12} = + 97,500 \text{ lb.} \\ &= + 13,500 \end{aligned}$$

Combined shears due to dead load plus live load.—

$$\text{At } A, S = - 1800 + 66,800 = + 65,000 \text{ lb.}$$

$$S = - 1800 - 77,000 = - 78,800 \text{ ,,}$$

$$B \text{ (left), } S = - 120,200 - 112,400 = - 232,600 \text{ lb.}$$

$$B \text{ (right), } S = + 112,270 + 113,300 = + 225,570 \text{ ,,}$$

$$C \text{ (left), } S = - 113,730 - 94,400 = - 208,130 \text{ ,,}$$

$$C \text{ (right), } S = + 113,000 + 97,500 = + 210,500 \text{ ,,}$$

### Comparison of Crown Sections in Cases I and II.

The maximum positive crown moments (Figs. 102 and 104) are

$$(1) M = 23,310,000 \text{ in. lb. (constant moment of inertia).}$$

$$(2) M = 7,510,000 \text{ ,, (variable ,, ,, ,, ).}$$

In the design for case (2) the overall crown depth was made for structural reasons 3 ft. 6 in., and the section was reinforced with twelve 1½-in. bars in tension. The concrete stress is given by equation (17),

$$c = \frac{M}{\left(1 - \frac{t'}{2nd}\right) Bt'(d-z)}$$

$$\text{where, from (19) and (18), } n = \frac{p'm + \frac{1}{2}\left(\frac{t'}{d}\right)^2}{p'm + \frac{t'}{d}} \text{ and } z = \frac{\left(2n - \frac{4t'}{3d}\right)t'}{2\left(2n - \frac{t'}{d}\right)}$$



$$p' = \frac{14.72}{84 \times 37.5} = 0.0047; \quad n = \frac{(15 \times 0.0047) + \frac{1}{2} \left( \frac{8.5}{37.5} \right)^2}{(15 \times 0.0047) + \frac{8.50}{37.5}} = 0.323.$$

$$z = \frac{\left( 0.646 - \frac{4 \times 8.5}{3 \times 37.5} \right) 8.5}{2 \left( 0.646 - \frac{8.5}{37.5} \right)} = 3.5 \text{ in. and } (d - z) = 34 \text{ in.}$$

$$c = \frac{7,510,000}{\left( 1 - \frac{8.5}{0.646 \times 37.5} \right) 84 \times 8.5 \times 34} = 475 \text{ lb. per square inch.}$$

$$l = \text{steel stress} = \frac{7,510,000}{14.72 \times 34} = 15,000 \text{ lb. per square inch.}$$

The required depth to give a similar stress for case (1) with  $M = 23,310,000$  in. lb. would be approximately

$$d = \frac{5 \times 8.5}{3} + \frac{23,310,000}{475 \times 84 \times 8.5} = 82.5 \text{ in., or } 87 \text{ in. overall.}$$

The ratio of depths =  $\frac{87}{53} = 2.07$ .

By designing with deep haunches and a continuous bottom slab the crown depth has been reduced to about  $\frac{1}{25}$  of the span, as against about  $\frac{1}{12}$  for the ordinary type beam design (using the same stresses).

If a concrete stress of 750 lb. per square inch and a steel stress of 16,000 lb. per square inch are allowed the minimum depths are found to be 5 ft. 3 in. for case (1) with uniform moment of inertia, and 2 ft. 9 in. for case (2) with varying moment of inertia. The extreme depth can therefore be reduced for these stresses, and without the use of compressive steel, to  $\frac{1}{32}$  of the span for variable moment of inertia as against  $\frac{1}{16}$  of the span for uniform moment of inertia. Further reduction in depth can be made if stresses of 18,000 and 950 lb. per square inch or other higher stresses are used.

**Design with Variable Moment of Inertia.**

(1) Crown section (*Fig. 105*).—As previously, 3 ft. 6 in. deep overall and reinforced with twelve  $1\frac{1}{4}$ -in. bars in the bottom.

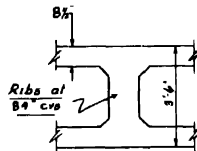

**Fig. 105.**

(2) Springing section (*Fig. 107*).— $M = 59,920,000$  in. lb. Here

$d = 240 \text{ in.} - 4\frac{1}{2} \text{ in.} = 235.5 \text{ in., } z = 10 \text{ in., } k = 0.156,$   
and the lever arm = 225.5 in.

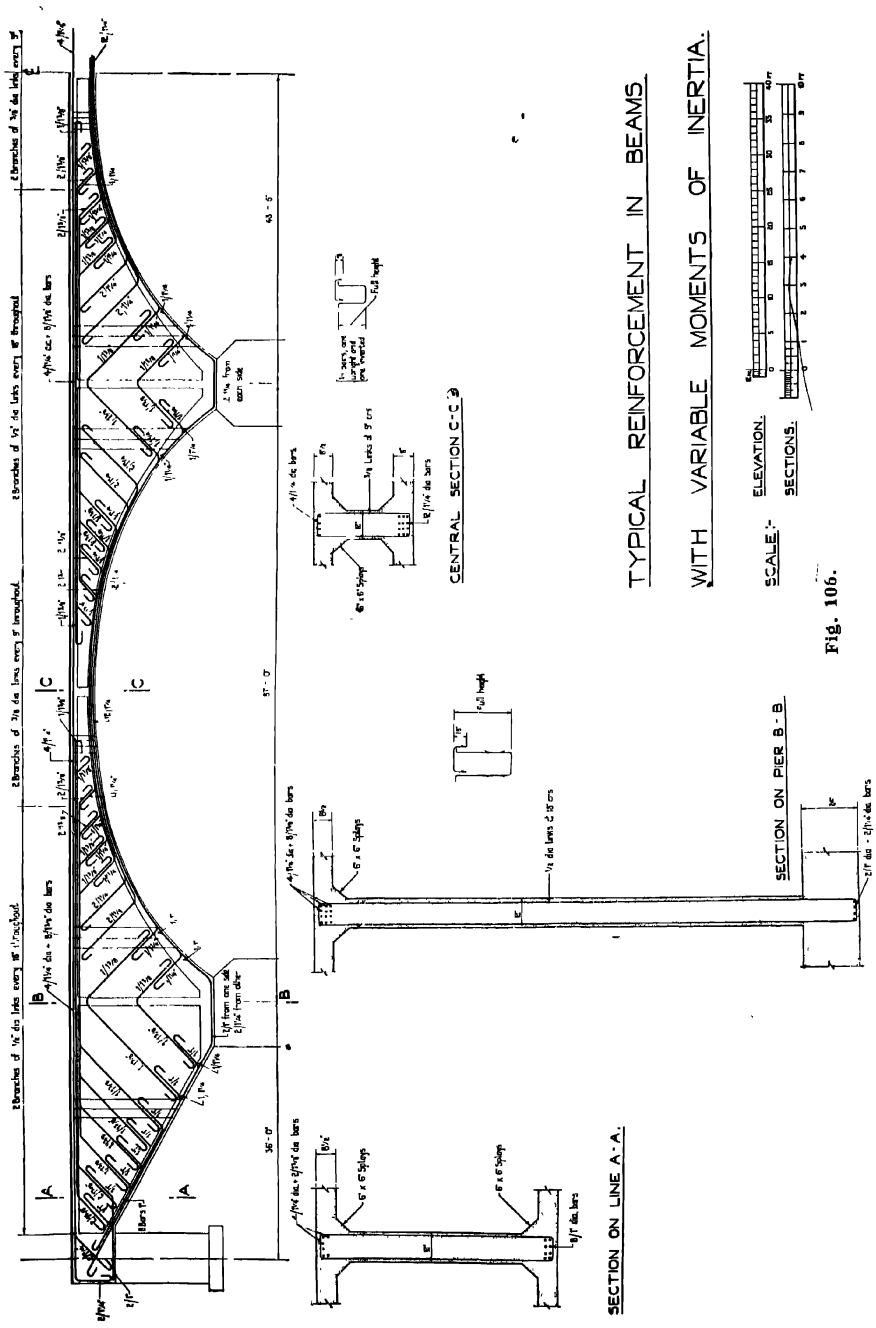

TYPICAL REINFORCEMENT IN BEAMS  
WITH VARIABLE MOMENTS OF INERTIA.

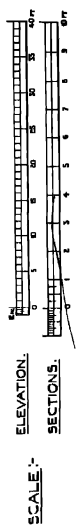

Fig. 106.

Four 1¼-in. and eight 1⅜-in. reinforcement bars = 16.8 sq. in. in tension.

$$\text{Steel stress} = \frac{59,920,000}{16.8 \times 225.5} = 15,800 \text{ lb. per square inch.}$$

The concrete stress is given approximately by

$$c = \frac{59,920,000}{\left(1 - \frac{24}{0.312 \times 235.5}\right) 84 \times 24 \times 225.5} = 196 \text{ lb. per square inch.}$$

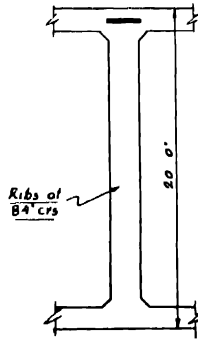

Fig. 107.

The arrangement of steel is shown on *Fig. 106*, and it will be noted that four 1¼-in. bars are carried through continuously at the top to assist in framing up the stirrup reinforcement. The bottom bars should be bent up into the ribs to give a secure connection between the 8-in. soffit slab and the ribs; since the soffit slab will be concreted before the ribs, and allowed to set, it is necessary to obtain a connection between the two; this is best done by bending up the bars, since the stirrups are not very effective for this purpose owing to their inclination to the soffit towards the ends of the span.

## CHAPTER V

### DESIGN OF PORTAL FRAME BRIDGES

THE hinged portal is a statically indeterminate structure, and it is necessary to find an expression for the magnitude of the horizontal thrust by the elastic theory before the bending moments can be determined statically. Formulæ follow for a rectangular hinged portal under any system of horizontal and vertical forces and with variations in the moment of inertia at any point in the frame. These do not allow for the effect of shortening of the top member due to the horizontal thrust as this is practically negligible. The results can be obtained by the Theory of Least Work or by slope-deflections, but for the sake of brevity examples showing the application only to practical design are included here.

CASE I (*Fig. 108*)—Uniformly distributed load  $w$  lb. per foot on  $BC$ .

If  $I_1$  = the moment of inertia of the vertical members,  $I_2$  = the moment of inertia of the horizontal member, and  $k = \frac{I_2 h}{I_1 l}$ ,  $H = \frac{w l^2}{4h(2k + 3)}$  and  $M_B = M_C = -hH$ .

CASE II (*Fig. 109*).—With a point load  $W$  on  $BC$

$$H = \frac{3Wab}{2hl(2k + 3)}$$

$$M_B = M_C = hH.$$

The maximum positive moment  $M = \frac{Wab}{l} - hH$

$$V_A = \frac{Wb}{l}.$$

CASE III (*Fig. 110*).—With a triangular load varying from zero at the top to  $p$  lb. per linear foot at the bottom of each post

$$H = \frac{ph}{20} \cdot \frac{11k + 20}{2k + 3}$$

$$M_B = M_C = hH - \frac{ph^2}{3}.$$

CASE IV (*Fig. 111*).—For uniformly distributed load of  $p$  lb. per linear foot on one post

$$H = \frac{ph}{8} \cdot \frac{11k + 18}{2k + 3}$$

$$V = \frac{ph^2}{2l}$$

and  $M_B = M_C = Hh - \frac{ph^2}{2}.$

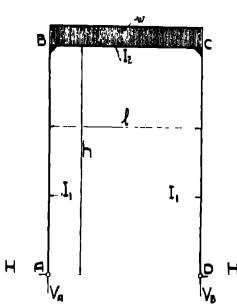

Fig. 108.

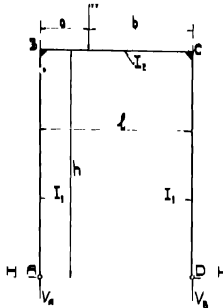

Fig. 109.

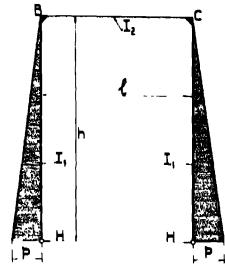

Fig. 110.

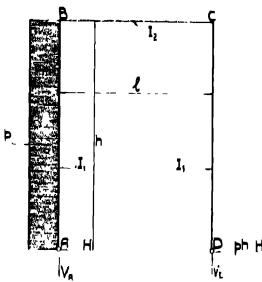

Fig. 111.

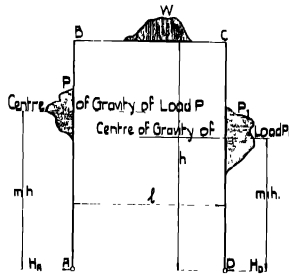

Fig. 112.

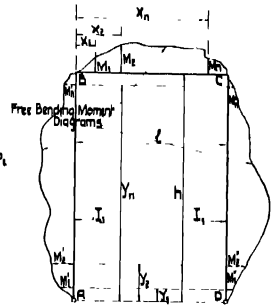

Fig. 113.

GENERAL CASE (A) (Fig. 112).—With three loads as shown in the illustration

$$H_A = -P + \frac{1}{2}(mP + m_1P_1) + \frac{k}{h^3} \cdot Q_1 + \frac{1}{hl} Q_2 + \frac{k}{h^3} Q_3 + \left( \frac{1}{h^2} \times K_t \right) \quad (1 + \frac{2}{3}k)$$

$M_B$  and  $M_C$  may now be found statically (Fig. 113) and  $M_B = -hH_A - Ph(1 - m)$ .

The following additional notation is required :

$Q_1$  = the area of the " free " bending moment diagram (for the load  $P$ ) multiplied by the distance of its centre of gravity from  $A$ ,

$Q_2$  = the area of the " free " bending moment diagram for the load  $W$ ,

$Q_3$  = the area of the " free " bending moment diagram (for the load  $P_1$ ) multiplied by the distance of its centre of gravity from  $D$ ,

$K_t$  = the factor allowing for the effect of temperature changes

$$= \epsilon \times E \times I_2 \times t'$$

where  $\epsilon$  = the coefficient of expansion for a rise or fall in temperature of 1 deg. F.,

$E$  = the modulus of elasticity,

$I_2$  = the moment of inertia of the horizontal member, and

$t$  = the variation in temperature in deg. F., a rise being positive and a fall negative.

$Q_1$ ,  $Q_2$ , and  $Q_3$  may be found accurately by dividing  $h$  and  $l$  into a number of equal divisions (eight to twelve are usual). If  $(n + 1)$  equals the number of divisions in a vertical or horizontal member,

$$Q_1 = \frac{h}{n + 1} [(M_1' \times y_1) + (M_2' \times y_2) + \dots + (M_n' \times y_n)]$$

where  $M_1'$ ,  $M_2'$ , etc., are the "free" bending moments at points 1, 2, etc., respectively, and  $y_1$ ,  $y_2$ , etc., are the distances of points 1, 2, etc., respectively from  $A$  (see Fig. 113).

$$Q_2 = \frac{l}{n + 1} (M_1 + M_2 + \dots + M_n)$$

$$Q_3 = \frac{h}{n + 1} [(M_1'' \times y_1) + (M_2'' \times y_2) + \dots + (M_n'' \times y_n)]$$

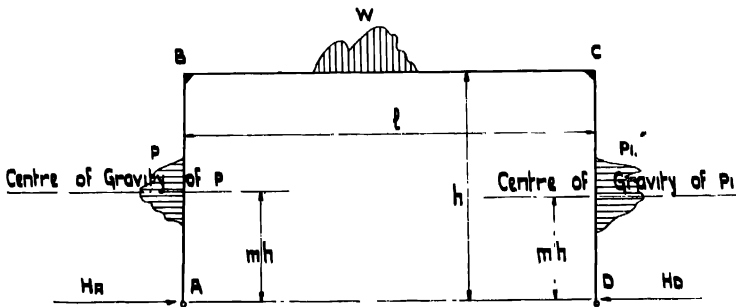

Fig. 114.

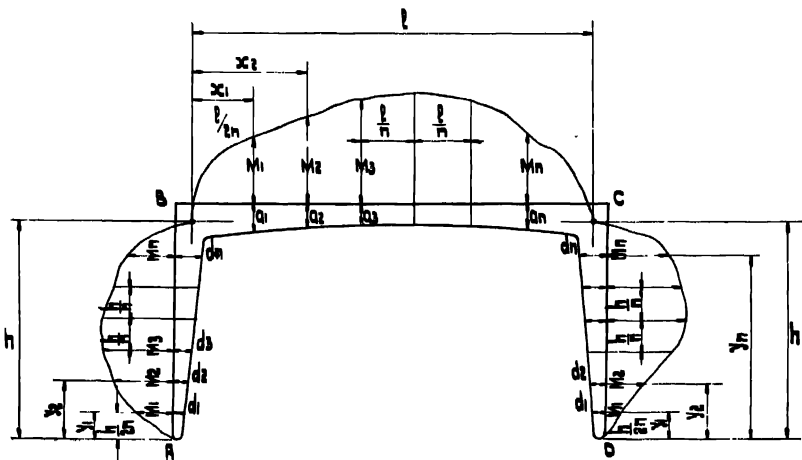

Fig. 115.

In the great majority of cases the values of  $Q_1$ ,  $Q_2$ , and  $Q_3$  can be found by addition from the following results :

(1) A concentrated load  $P$  at a distance  $a$  from the point  $A$

$$Q_1 = \frac{1}{6}a(h^2 - a^2)P$$

(2) A uniformly distributed load  $p$  per linear foot over the full height  $h$  of the post

$$Q_1 = \frac{1}{24}ph^4$$

(3) A varying distributed loading  $p$  per linear foot at  $A$  diminishing uniformly to zero at  $B$

$$Q_1 = \frac{7}{360}ph^4$$

(4) A varying distributed loading zero at  $A$  and increasing uniformly to  $p$  at point  $B$

$$Q_1 = \frac{1}{45}ph^4$$

(5) A concentrated load  $P$  on the span  $BC$  distant  $a$  from  $B$

$$Q_2 = \frac{1}{8}Wa(l - a)l$$

(6) A uniformly distributed loading  $p$  per linear foot over the whole span  $BC$

$$Q_2 = \frac{1}{12}pl^3$$

The result for a system of loads can be obtained from (1) and (6) by summation.

EFFECT OF TEMPERATURE CHANGES.—Due to variation in temperature

$$H = \frac{3EI_2t}{h^2(3 + 2k)}, \text{ and } M_B = M_C = -hH$$

For a rise in temperature  $t$  is positive. For a fall in temperature  $t$  is negative.

The preceding formulæ only apply to symmetrical two-hinged rectangular portal frames with vertical or horizontal members of uniform cross section.

**Formulæ for Hinged Portal Frames.**

GENERAL CASE (B) (Figs. 114 and 115).—In this case

$$H_A = -P + \frac{1}{2}(m_1.P_1 + mP) + \frac{S_1 + lS_2 + S_3 + K_t}{2K_1 + hlK_2}$$

where  $S_1 = \left( \frac{M_1'.y_1}{d_1^3} + \frac{M_2'.y_2}{d_2^3} + \dots + \frac{M_n'.y_n}{d_n^3} \right)$

$$S_2 = \left( \frac{M_1}{a_1^3} + \frac{M_2}{a_2^3} + \dots + \frac{M_n}{a_n^3} \right)$$

$$S_3 = \left( \frac{M_1''.y_1}{d_1^3} + \frac{M_2''.y_2}{d_2^3} + \dots + \frac{M_n''.y_n}{d_n^3} \right)$$

$$K_t = \frac{b(n + 1)}{12} \times \epsilon.t.\frac{l}{h}.E \text{ (the temperature factor)}$$

$$K_2 = \left( \frac{I}{a_1^3} + \frac{I}{a_2^3} + \dots + \frac{I}{a_n^3} \right) \text{ and}$$

$$K_1 = \left( \frac{y_1^2}{d_1^3} + \frac{y_2^2}{d_2^3} + \dots + \frac{I}{d_n^3} \right)$$

$b$  = the breadth of the vertical and horizontal members of the frame and is assumed to be constant.

The remainder of the notation is shown on the diagrams, or has been given previously.

An example will be given to show the simplicity of the application of this formula, which it is believed was given for the first time by one of the writers in "Concrete and Constructional Engineering," December, 1934. When the horizontal thrust  $H_A$  has been determined the moments and vertical loading may be determined statically, thus  $M_h = -hH_A - P(1 - m)h$ .

### The Hinged Portal.

The portal type of bridge can be used effectively in cases where headroom is strictly limited over the full span, and where the span is not too great, and especially if the roadway is wide. These conditions would constitute an ideal case for a portal. An arch would be impossible due to the reduction of headroom at the ends of the span; a parapet girder scheme would not be economical for a wide roadway on account of the heavy secondary beam system required, and a freely-supported girder bridge would also be handicapped by the headroom condition. Another case suitable for the use of the portal type occurs when an arch construction is unsuitable on account of the difficulty of dealing with abutment thrusts due to low bearing capacity of the ground.

For spans up to 24 ft. it is generally advisable to avoid ribs, and span with a slab only. This simplifies the construction without appreciably increasing the cost. The design worked out is for a bridge required to carry a roadway for trucks between one section of a works and another on the opposite side of an existing thoroughfare. The new truckway was required to slope down on each side of the existing road, giving a clear headroom of 12 ft. between the soffit of the bridge and the top of the road. *Fig. 116* shows a plan and section of the structure, and the full working calculations are as follows.

The two walls and deck slab form a frame which can be assumed to be hinged at a point just above the base slab. The effective height is reckoned as 14 ft. and the effective span as 24 ft. The deck load forms a large proportion of the total load, and a rough calculation is required to determine the approximate slab thickness required. The live load was given as a concentration of 22 tons on a width of 10 ft., and the ground surcharge as 400 lb. per square foot.

Assuming a 24-in. deck slab partially fixed at the ends, and a point load of 4940 lb. at midspan equivalent to 22 tons on 10 ft.,

$$\begin{aligned} M_p &= 4940 \times 24 \times \frac{1}{4}^2 \times 0.7 = 249,000 \\ M_d &= 288 \times 24^2 \times \frac{1}{12} = 166,000 \end{aligned}$$

415,000 in. lb.

Assuming the maximum compressive strength in the concrete at 750 lb. per square inch,  $m = 15$ , and  $t = 16,000$  lb. per square inch,

$$d = \left\{ \frac{415,000}{133.5 \times 12} \right\}^{\frac{1}{2}} = 16.15 \text{ in.}$$



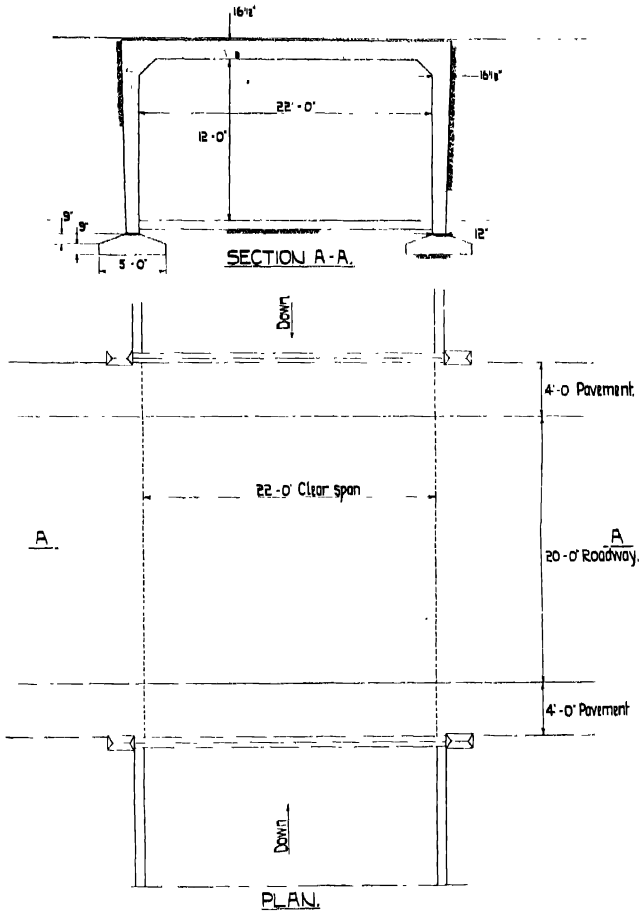

Fig. 116.

Assuming a total slab thickness of 18 in., the following adjustments in span, etc., may be made.

$$\text{Span} = l = \text{clear span} + d = 23.5 \text{ ft.}$$

$$h = 13.75 \text{ ft.}$$

$$\text{Live load} = 22 \times \frac{2240}{10} = 4940 \text{ lb. acting at midspan.}$$

Average thickness of walls = 15 in.

|                    |       |
|--------------------|-------|
| Dead loading       | lb.   |
| 18-in. slab        | = 216 |
| 2-in. road surface | = 24  |

Side Pressure.—

$w$  = density of earth = 100 lb. per cubic foot.

$\phi$  = angle of repose = 35 deg.

$$w \left\{ \frac{1 - \sin \phi}{1 + \sin \phi} \right\} = K = 27 \text{ lb.}; \text{ pressure at depth } h = Kh.$$

Assuming the surcharge at 400 lb. per square foot,  $p_s = 400 \times 0.27 = 108$  lb. per square foot acting uniformly over the whole face of the wall.

It will be a safe assumption to take  $\frac{1}{2}p$  as the dead load and  $p_s + \frac{1}{2}p$  as the live load; this will allow for the full value of  $p$  and, at the same time, for a possible shrinkage of the filling away from the face of the wall. The dead load moments and thrusts will first be worked out, and then combined with the moments and thrusts due to the live loads.

The values of the moments and thrusts may be found by means of the formulæ for hinged portal frames previously given.

$$\text{In this case } k = \frac{I_2 h}{I_1 l} = \frac{1.5^3 \times 13.75}{1.25^3 \times 23.5} = 1.01.$$

For the uniformly distributed dead load on the deck slab

$$H = \frac{WL^2}{4h(2k+3)} = \frac{240 \times 23.5^2}{4 \times 13.75(2 \times 1.01 + 3)} = 480 \text{ lb.}$$

$$M_B = M_C = \frac{1}{2}hH = \frac{1}{2} \times 13.75 \times 12 \times 480 \text{ lb.} = 79,200 \text{ in. lb.}$$

$$V_A = 240 \times \frac{23.5}{2} = 2820 \text{ lb.}$$

For the point load acting at midspan

$$H = \frac{3Pl}{8h(2k+3)} = \frac{3 \times 4940 \times 23.5}{8 \times 13.75(2 \times 1.01 + 3)} = 630 \text{ lb.}$$

$$M_B = M_C = \frac{1}{2}hH = \frac{1}{2} \times 13.75 \times 12 \times 630 \text{ lb.} = 104,000 \text{ in. lb.}$$

$$V_A = 4940 \text{ lb.} \times \frac{1}{2} = 2470 \text{ lb.}$$

Considering one-half of the unsurcharged earth pressure to act against each vertical member,

$$p = 13.75 \times \frac{27}{2} \text{ lb.} = 185 \text{ lb.}$$

$$H = \frac{ph}{20} \frac{11k+20}{2k+3} = \frac{185 \times 13.75}{20} \times \frac{(11 \times 1.01) + 20}{(2 \times 1.01) + 3} = 795 \text{ lb.}$$

$$M_B = M_C = \left( hH - \frac{ph^2}{3} \right) = \left[ 13.75 \times 795 - \frac{186 \times 13.75^2}{3} \right] \frac{1}{2}$$

$$= -9450 \text{ in. lb.}$$

$$V_A = 0.$$

Considering earth pressure due to surcharge acting against the wall  $AB$ ,

$$H_A = \frac{p_s h}{8} \times \frac{11k+18}{2k+3} = \frac{108 \times 13.75}{8} \times \frac{(11 \times 1.01) + 18}{(2 \times 1.01) + 3} = 1075 \text{ lb.}$$

$$M_B = \left( hH - \frac{ph^2}{2} \right) = \left[ 1075 \times 13.75 - \frac{108 \times 13.75^2}{2} \right] 12 = 55,200 \text{ in. lb.}$$

$$V = \frac{ps h^2}{2l} = \frac{108 \times 13.75^2}{2 \times 23.5} = 435 \text{ lb.}$$

$$H_D = ps h + H_A = 108 \times 13.75 - 1075 = 410 \text{ lb.}$$

$$M_C = -H_D \times h = -410 \times 13.75 \times 12 = -67,700 \text{ in. lb.}$$

With earth pressure due to surcharge against the wall *CD*, by symmetry with the preceding case,

$$\begin{aligned} H_A &= 410 \text{ lb.} & H_D &= -1075 \text{ lb.} \\ M_B &= -67,700 \text{ in. lb.} & M_C &= 55,200 \text{ in. lb.} \end{aligned}$$

Effect of rise in temperature of 20 deg. F.,

$$H = \frac{3\epsilon EI_s t}{h^2(3+2k)} = \frac{3 \times 0.000006 \times 2,000,000 \times \frac{12 \times 18^3}{12} \times 20}{165^2(3+2 \times 1.01)} = 31 \text{ lb.}$$

$$M_B = M_C = -31 \times 165 = -5110 \text{ in. lb.}$$

Effect of fall in temperature of 20 deg. F.,

$$H = -31 \text{ lb.}, \quad M_B = M_C = 5110 \text{ in. lb.}$$

The values of *H*, *V<sub>A</sub>*, *M<sub>B</sub>*, and *M<sub>C</sub>* are tabulated, and, by combining them, the maximum moments and thrusts may be found.

The maximum negative moment at *B* (or *C*) is

$$M_B = -79,200 - 104,000 - 9450 - 67,700 - 5110 = -265,460 \text{ in. lb.}$$

For this moment

$$V_A = 2820 + 2470 + 435 = 5725 \text{ lb.}$$

The maximum positive moment occurs at midspan of the deck slab when the point load of 4940 lb. is at that point, the side pressure is a minimum, and there is at the same time a fall in temperature. The value of the maximum positive moment may be found by subtracting the negative moment at *B* (or *C*) from the "free" bending moment.

$$\begin{aligned} \text{Maximum positive moment} &= (240 \times 23.5^2 \times \frac{1}{8}) + (4940 \times 23.5 \times \frac{1}{4}) \\ &\quad - 79,200 - 9450 - 104,000 + 5110 = 359,250 \text{ in. lb.} \end{aligned}$$

The thrusts and moments due to the dead and live loads are shown in *Table XVI*.

*Fig. 117* shows the maximum positive moment with the accompanying moments on other parts of the frame.

*Fig. 118* shows the maximum negative moment in one of the vertical members. The preceding is the usual method of calculation; in most cases the maximum negative moment will be much less than shown, since the passive earth pressure will come into action on the wall opposite to the one surcharged up to any level

$$\text{not greater than } \frac{1 + \sin \phi}{1 - \sin \phi} w h.$$

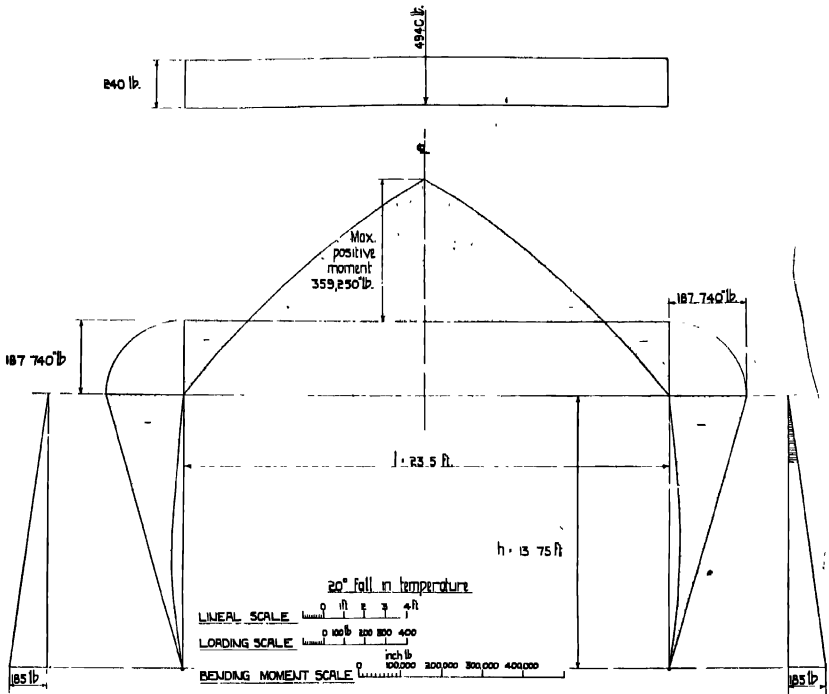

Fig. 117.—Maximum Positive Bending Moment.

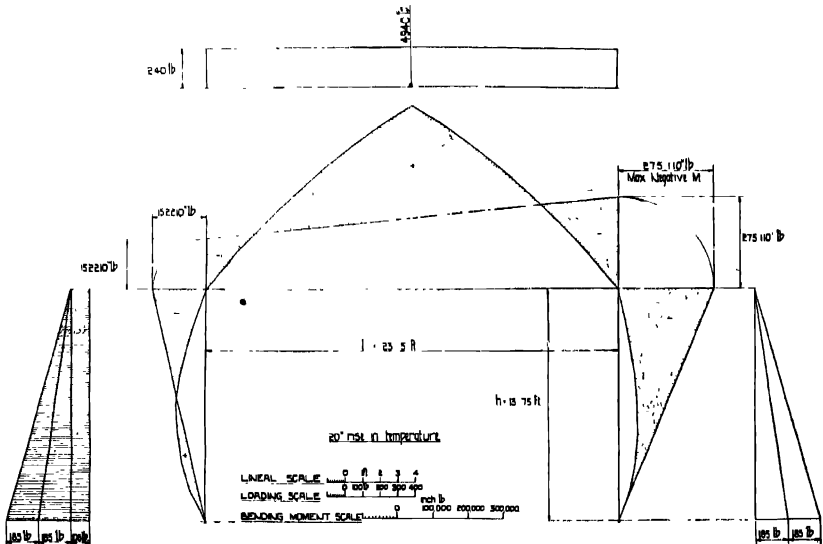

Fig. 118.—Maximum Negative Bending Moment.

The total slab thickness of the decking may be made  $16\frac{1}{2}$  in. with an effective depth of 15 in. The area of steel required in the bottom of the deck slab is

$$A_t = \frac{359,250}{16,000 \times 15 \times 0.88} = 1.7 \text{ sq. in.}$$

that is,  $1\frac{1}{8}$ -in. bars at 7-in. centres. One-inch diameter bars are used at 7-in. centres in the top of the slab at the supports.

TABLE XVI.  
DEAD LOADS.

| Loading   | H (lb.) | V <sub>A</sub> (lb.) | M <sub>B</sub> (in. lb.) | M <sub>O</sub> (in. lb.) |
|---|---------|----------------------|--------------------------|--------------------------|
| Uniform load on decking . . . . .                                 | 480     | 2820                 | - 79,400                 | - 79,400                 |
| *One-half the unsurcharged earth pressure on both walls . . . . . | - 795   |                      | 9450                     | - 9450                   |
| Total effect of dead loads . . . . .                              | - 315   | 2820                 | - 88,850                 | - 88,850                 |

\* The other half is added and treated as a live load.

LIVE LOADS.

| Loading  | H (lb.) | V <sub>A</sub> (lb.) | M <sub>B</sub> (in. lb.) | M <sub>O</sub> (in. lb.) |
|--|---------|----------------------|--------------------------|--------------------------|
| Point load at midspan of deck . . . . .                          | 630     | 2470                 | - 104,000                | - 104,000                |
| One-half the unsurcharged earth pressure on both walls . . . . . | - 795   | 0                    | - 9450                   | - 9450                   |
| Earth pressure due to surcharge on wall AB . . . . .             | - 1075  | - 435                | 55,200                   | - 67,700                 |
| Earth pressure due to surcharge on wall CD . . . . .             | 410     | 435                  | - 67,700                 | 55,200                   |
| Effect of rise in temperature of 20 deg. . . . .                 | 31      | 0                    | - 5110                   | - 5110                   |
| Effect of fall in temperature of 20 deg. . . . .                 | - 31    | 0                    | + 5110                   | + 5110                   |

The general arrangement of the reinforcement is shown in Fig. 119. It will be seen that the vertical members are of varying width, although no allowance was made in the calculations for a varying moment of inertia. The difference between the results obtained by calculations taking into account a varying moment of inertia in the vertical members and the preceding calculations is much greater than a superficial consideration would lead one to expect, and for large or important structures the more accurate method should be used. In order to demonstrate the simplicity of the method allowing for vertical members of varying width, the preceding case will be worked out again, and the effect will be shown of the variation in the moments of inertia of the posts.

The height will be divided into nine equal lengths of 1.53 ft. each making the assumed total height 13.77 ft.

The span will be divided into nine equal lengths of 2.61 ft., making a total length of 23.49 ft. The vertical members will be assumed to slope uniformly from  $16\frac{1}{2}$  in. at the top to 12 in. at the bottom, and the deck will be assumed to have a constant thickness of  $16\frac{1}{2}$  in. The case worked out will be that producing the maximum positive moment at midspan, that is, with minimum side pressure, and the point load of 4940 lb. at midspan. It will be necessary to draw the "free" bending moment diagrams for the horizontal pressure and for the

combined vertical point load and the uniformly distributed load. The values of  $y$ ,  $y^2$ ,  $d$ ,  $d^3$ , etc., are given in *Tables XVII and XVIII*, and are substituted in the formula for  $H$ . It will be noted that the points given in the tables are located at the centroid of each division.

TABLE XVII

| Point   | $y$ (ft) | $y^2$  | $d$ (ft) | $d^3$ | $M'$<br>(ft. lb) | $\frac{y^2}{d^3}$        | $\frac{M'y}{d^3}$        |
|---------|----------|--------|----------|-------|------------------|--------------------------|--------------------------|
| 1 . . . | 0.765    | 0.585  | 1.021    | 1.064 | 600              | 0.554                    | 431                      |
| 2 . . . | 2.295    | 5.27   | 1.063    | 1.201 | 1497             | 4.388                    | 2861                     |
| 3 . . . | 3.825    | 14.63  | 1.104    | 1.346 | 2031             | 10.87                    | 5772                     |
| 4 . . . | 5.355    | 28.68  | 1.146    | 1.505 | 2251             | 19.01                    | 8009                     |
| 5 . . . | 6.885    | 47.40  | 1.188    | 1.676 | 2205             | 28.28                    | 9005                     |
| 6 . . . | 8.415    | 70.81  | 1.229    | 1.856 | 1940             | 38.15                    | 8795                     |
| 7 . . . | 9.945    | 98.90  | 1.271    | 2.053 | 1507             | 48.17                    | 7300                     |
| 8 . . . | 11.475   | 131.68 | 1.313    | 2.264 | 953              | 58.16                    | 4830                     |
| 9 . . . | 13.005   | 169.30 | 1.354    | 2.482 | 326              | 68.21                    | 1708                     |
|         |          |        |          |       |                  | 275.79                   | 48,711                   |
|         |          |        |          |       |                  | $\Sigma \frac{y^2}{d^3}$ | $\Sigma \frac{M'y}{d^3}$ |

TABLE XVIII.

| Point   | $a$ (ft) | $a$   | $a^3$ | $M$    | $\frac{1}{a^3}$        | $\frac{M}{a^3}$         |
|---------|----------|-------|-------|--------|------------------------|-------------------------|
| 1 . . . | 1.306    | 1.375 | 2.6   | 6702   | 0.385                  | $\frac{6702}{2.6}$      |
| 2 . . . | 3.917    | "     | "     | 18,878 | "                      | $\frac{18,878}{2.6}$    |
| 3 . . . | 6.528    | "     | "     | 29,418 | "                      | $\frac{29,418}{2.6}$    |
| 4 . . . | 9.139    | "     | "     | 38,314 | "                      | $\frac{38,314}{2.6}$    |
| 5 . . . | 11.750   | "     | "     | 45,583 | "                      | $\frac{45,583}{2.6}$    |
| 6 . . . | 14.361   | "     | "     | 38,314 | "                      | $\frac{38,314}{2.6}$    |
| 7 . . . | 16.972   | "     | "     | 29,418 | "                      | $\frac{29,418}{2.6}$    |
| 8 . . . | 19.583   | "     | "     | 18,878 | "                      | $\frac{18,878}{2.6}$    |
| 9 . . . | 22.194   | "     | "     | 6702   | "                      | $\frac{6702}{2.6}$      |
|         |          |       |       |        | $\Sigma \frac{1}{a^3}$ | $\Sigma \frac{M}{a^3}$  |
|         |          |       |       |        | = $9 \times 0.385$     | = $\frac{232,207}{2.6}$ |
|         |          |       |       |        | = 3.465                | = 89,310                |

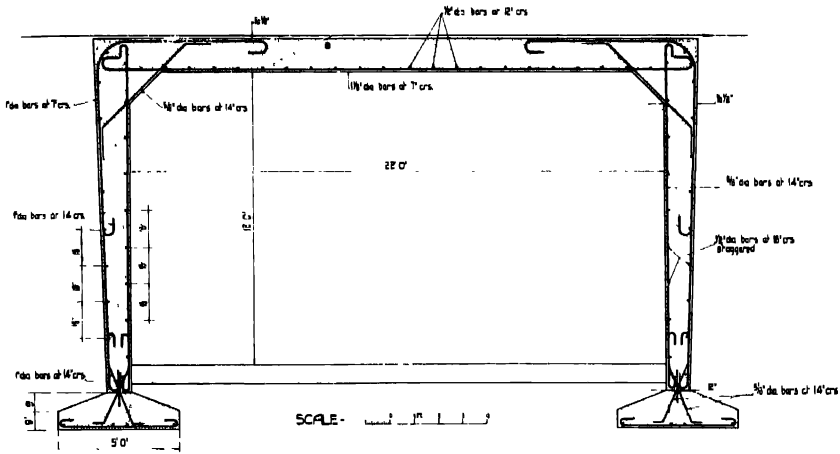

Fig. 119.—Arrangement of Reinforcement.

$$H_A = -P + \frac{1}{2}(mP + m_1P_1)$$

$$2 \sum_0^h \frac{M'y}{d^3} + l \sum_0^l \frac{M}{a^3} + \frac{b}{12}(n+1) \frac{l}{h} .e.tE$$

$$hl \sum_0^u \frac{1}{d^3} + 2 \sum_0^h \frac{y^2}{d^3}$$

$$= -853 +$$

$$(2 \times 48,711) + (23.5 \times 89,310) - \left( \frac{10}{12} \times \frac{23.5}{13.77} \times 6 \times 10^{-6} \times 20 \times 2 \times 10^6 \times 144 \right)$$

$$\frac{(13.77 \times 23.5 \times 3.465) + (2 \times 275.79)}{}$$

$$= -853 + 1289 = 436 \text{ lb.}$$

The values of  $H_A$  obtained before are as follows :

|                         |                            |                                |         |
|-------------------------|----------------------------|--------------------------------|---------|
| $H_A$ due to horizontal | uniformly distributed load | = 480                          |         |
| "                       | "                          | point load at midspan          | = 630   |
| "                       | "                          | half uncharged earth pressure  | = - 795 |
| "                       | "                          | fall in temperature of 20 deg. | = - 31  |
|                         |                            | 284                            |         |

The difference is 436 lb. - 284 lb. = 152 lb.

$$M_B = M_C = [(-436 \times 13.77) - (3.5 \times 13.77^3 \times \frac{1}{3})] \cdot 12$$

$$= -216,000 \text{ in. lb.}$$

Maximum positive moment at midspan

$$= (240 \times 23.52^2 \times \frac{1}{8}) + (4940 \times 23.52 \times \frac{1}{4}) - 216,000 = 331,000 \text{ in. lb.}$$

The maximum positive moment obtained by the previous calculations was 358,600 in. lb., a difference of 27,600 in. lb., or approximately 8 per cent.

It will be gathered from these results that sloping vertical members are economical, as they provide stiffness where it is most needed.

In some cases, especially with large spans, the differences due to varying moments of inertia may be much greater than in the previous example. For instance, such a case would arise with a ribbed design when deep haunches are required at the angles, and where the slab between the ribs is placed so as to afford the maximum resisting moments, being diverted to the soffits of the ribs beyond the contraflexure points, a change over also occurring in the posts. In such a case, the moments of inertia at the ends of the span may be large compared with those in the centre, with a consequent increase of the bending moments at the intersection and a diminution of the central positive moments in the deck span. For this reason it may be in some cases necessary to apply the general formulæ, although normally it is sufficient to assume constant moments of inertia in the members.

Most sections of members of a portal frame are subject to a direct thrust in addition to the bending moment. Methods of calculating the stresses for such conditions are given in the next chapter.

### **Fixed Portal Frames.**

Only portal frames with hinges at the bottoms of the vertical members are considered in the foregoing. Portal frames, the bottoms of the vertical members of which are fixed, are not analysed, as in practice there is difficulty in ensuring that complete fixity or a predetermined degree of partial fixity is obtained. Should the assumed degree of fixity not be obtained, the bending moments, thrusts, and shearing forces on the frame may vary considerably from those provided for in the design. It is therefore preferable to insert hinges at the bottoms of the vertical members, thereby ensuring compliance with the assumption that there is no bending moment at these points.

In addition to the calculations for a fixed portal frame being more complex than for a hinged frame, the effects of unequal settlement of the foundations, shrinking of the concrete and changes of temperature are more serious on a fixed frame.



FIG. 120.

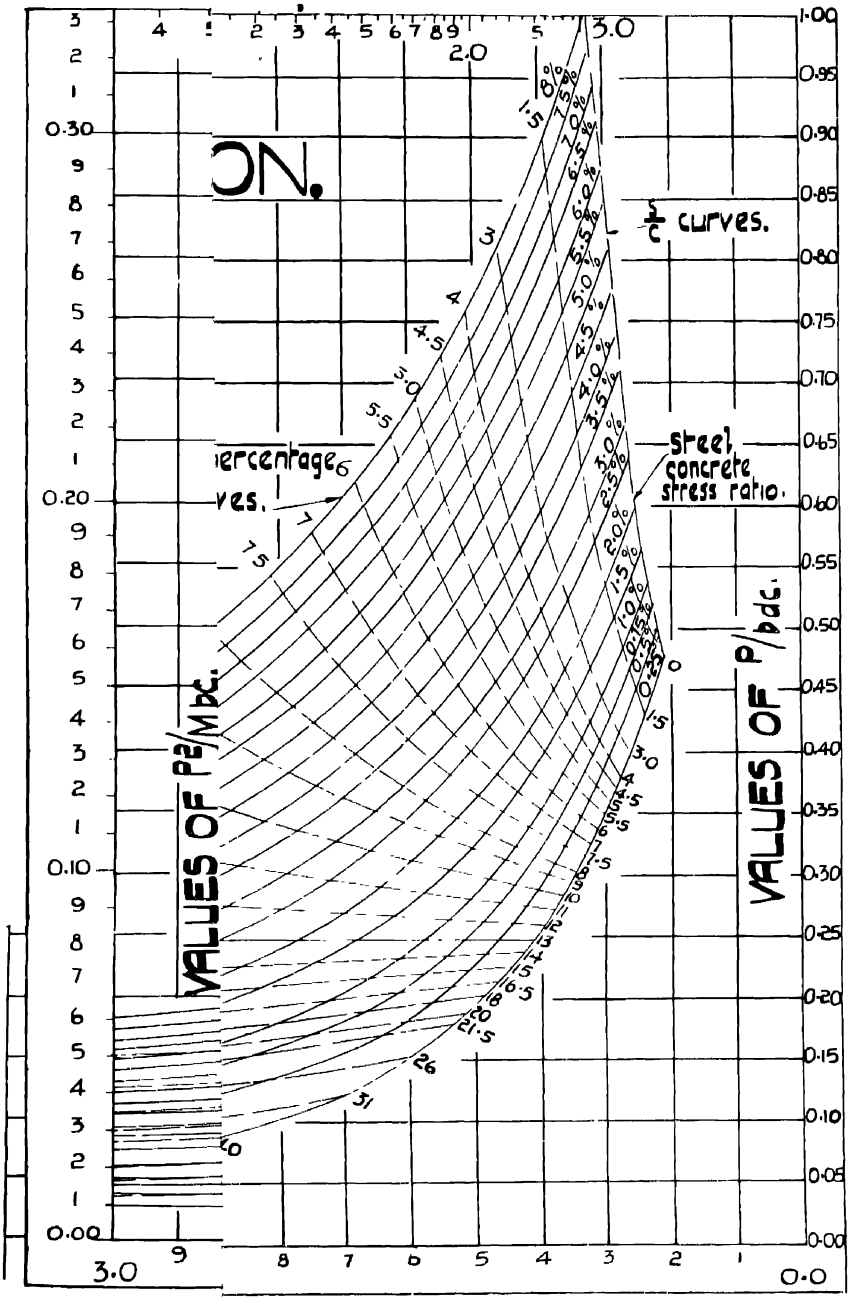



## CHAPTER VI

### COMBINED THRUST AND BENDING

#### Calculation of Rectangular Sections Reinforced equally on Two Faces.

THE problem of combined thrust and bending on reinforced concrete sections offers little trouble from the theoretical standpoint, and it is only when an attempt is made to express the solution in a simple practical form that any difficulty arises. Unless a form of graph or table is used it is necessary to assume a section with a certain percentage of reinforcement and find the depth of the neutral axis by the solution of a cubic equation. When the depth of the neutral axis is known, the compressive and tensile stresses in the concrete and steel may be found by simple formulæ. This method offers no real difficulties, but it is a long and tedious process to arrive at an economical section and several attempts may have to be made before a section is found which will keep the stresses within the desired limits.

Several methods have been devised to lessen the amount of calculation required, and many solutions have been published. The method given here is such that, any two of the three variables (breadth, depth, and steel percentage) being given, the third can be obtained immediately without the necessity of determining any subsidiary quantity, such as that defining the position of the neutral axis.

The following notation is used :

$M$  = bending moment (in. lb.)

$P$  or  $N$  = direct thrust (lb.)

$b$  = breadth of the section (in.)

$d$  = overall depth of the section (in.)

$A$  = area of reinforcement on either face of the section (sq. in.)

$c$  = maximum compressive stress in the concrete (lb. per square inch)

$s$  = tension stress in the steel (lb. per square inch)

$p$  = percentage of total reinforcement =  $\frac{200A}{bd}$

$m$  = modular ratio.

CASE I.—TENSION OCCURS ACROSS THE SECTION.—Where tension and compression occur across the section the graph on *Fig. 120* is applied as in the following examples.

Example (a).— $M = 1,400,000$  in. lb. ;  $P = 100,000$  lb. ;  $d = 24$  in. ;  $b = 15$  in. ; maximum allowable stress in concrete = 800 lb. per square inch.

To find the percentage of steel reinforcement required :

$$\frac{M}{Pd} = \frac{1,400,000}{100,000 \times 24} = 0.584 = \text{eccentricity ratio.}$$

$\frac{P}{bdc} = \frac{100,000}{24 \times 15 \times 800} = 0.347 = \text{ratio of stress in concrete section for central loading to allowable stress in reinforced section for eccentric loading.}$

The values of  $\frac{P}{bdc}$  are given on the right-hand vertical scale, and the values of  $\frac{M}{Pd}$  are given on the bottom horizontal scale. Find 0.347 on the right-hand vertical scale, project horizontally, and find 0.584 on the bottom horizontal scale and project vertically upwards. The intersection point will be found to be between the curves representing 2 per cent. and  $2\frac{1}{2}$  per cent. of steel, and 2.5 will be used as the approximate percentage required. The intersection point also lies between the curves representing the ratios  $\frac{s}{c} = 8$  and 9 respectively, and  $s$  (approximately)  $= 8.75 \times 800 = 7000$  lb. per square inch.

Example (b).— $M = 2,500,000$  in. lb. ;  $P = 120,000$  lb. ;  $d = 30$  in. ;  $p = 1.5$  per cent. ;  $c = 900$  lb. per square inch.

$$\text{To find the required value of } b, \frac{M}{Pd} = \frac{2,500,000}{120,000 \times 30} = 0.695.$$

Find the value of 0.695 on the bottom horizontal scale and project vertically upwards until the intersection point with the curve representing 1.5 per cent. is reached ; then project horizontally to the right where the value 0.24 for  $\frac{P}{bdc}$  is found.

$$\therefore b = \frac{120,000}{0.24 \times 900 \times 30} = 18.5 \text{ in. or, say, } 19 \text{ in.}$$

The intersection point lies between the curves representing  $\frac{s}{c} = 13$  and 14 respectively, and  $s = 13.5 \times 900 = 12,100$  lb. per square inch.

Example (c).— $M = 1,800,000$  in. lb. ;  $P = 150,000$  lb. ;  $b = 15$  in. ;  $p = 1$  per cent. ;  $c = 750$  lb. per square inch.

$$\text{To find the required value of } d, \frac{P^2}{Mbc} = \frac{150,000^2}{1,800,000 \times 15 \times 750} = 1.11.$$

Values of  $\frac{P^2}{Mbc}$  will be found on the left-hand vertical scale and continued on the top horizontal scale (1.11 is on the top scale), and a straightedge should be laid from this point to the point 0.0 at the junction of the bottom and the right-hand scales. Project horizontally from the intersection of the line 1.11 to 0.0 with the curve for  $p = 1$  per cent., and read the value 0.385 on the right-hand vertical scale.

$$\therefore \frac{P}{bdc} = 0.385$$

$$d = \frac{150,000}{15 \times 750 \times 0.385} = 34.6 \text{ in. or, say, } 35 \text{ in.}$$

$$s = 5.2 \times 750 = 3900 \text{ lb. per square inch.}$$

Example (d).— $M = 2,800,000$  in. lb. ;  $P = 600,000$  lb. ;  $b = 24$  in. ;  $p = 2$  per cent. ;  $c = 900$  lb. per square inch.

$$\frac{P^2}{Mbc} = \frac{600,000^2}{2,800,000 \times 24 \times 900} = 5.95.$$

The maximum value of  $\frac{P^2}{Mbc}$  given on the graph is 3, and therefore for the present example tension does not occur in the section. The example will be worked out under Case II.

It must be noted that the graph is strictly true only for a certain ratio of the cover of the steel to the depth of the beam. The graph has been worked out assuming the distance from the centre of the steel on one face to the centre of steel on the other face equals 0.85 of the total depth of the section, that is,  $0.85d$ . The general case is dealt with later.

CASE II.—NO TENSION ACROSS THE SECTION.—For this case a graph has not been prepared, since it is desirable where possible to obtain results by a direct formula. The formulæ given here assume that the distance from the centre of the steel on one face to the centre of steel on the opposite face is  $0.85d$ , and they have been simplified by an approximation which for practical purposes does not affect the result.

$$(i) d = \frac{P}{2b(1 + 0.14p)c} \left\{ 1 + \left( 1 + \frac{24cMb}{P^2} \right)^{\frac{1}{2}} \right\}$$

$$(ii) b = \frac{P}{dc(1 + 0.14p)} + \frac{6M}{d^2c(1 + 0.14p)^2}$$

$$(iii) c = \frac{P}{bd(1 + 0.14p)} + \frac{6M}{bd^2(1 + 0.14p)^2}$$

As before,  $p$  is the percentage of steel included in both faces of the section so that  $p = \frac{200A}{bd}$ ,  $A$  being the area on one face only.

$$(iv) p = \frac{P}{0.28bdc} \left\{ 1 + \left( 1 + \frac{24cMb}{P^2} \right)^{\frac{1}{2}} \right\} - 7.14$$

Example (e).— $M = 2,800,000$  in. lb.;  $P = 600,000$  lb.;  $b = 24$  in.;  $p = 4$  per cent.;  $c = 900$  lb. per square inch; required to determine  $d$ .

From the curves it is found that no tension exists across the section.

$$d = \frac{600,000}{2 \times 24(1 + 0.14 \times 4)900} \left\{ 1 + \left( 1 + \frac{24 \times 900 \times 2,800,000 \times 24}{(600,000)^2} \right)^{\frac{1}{2}} \right\}$$

= 29 in.

Example (f).— $M = 600,000$  in. lb.;  $P = 220,000$  lb.;  $c = 750$  lb. per square inch;  $b = 18$  in.;  $d = 18$  in.;

$$p = \frac{220,000}{0.28 \times 18 \times 18 \times 750} \left\{ 1 + \left( 1 + \frac{24 \times 750 \times 600,000 \times 18}{(220,000)^2} \right)^{\frac{1}{2}} \right\} - 7.14$$

= 3.35 per cent.

$$\text{Area of steel on each face} = \frac{18 \times 18 \times 3.35}{200} = 5.4 \text{ sq. in., say, three 1-in.}$$

and three  $1\frac{1}{8}$ -in. bars.

CASES I AND II FOR ANY MODULAR RATIO  $m$ .—The curves on *Figs.* 120 to 122 and 124 to 127 are drawn for  $m = 15$ . In the case of any other ratio  $m$  the curves

can still be used;  $p$  being the actual percentage to be placed, the percentage curve for  $\frac{mp}{15}$  can be used as already described. For instance 1.5 per cent. to be placed with a modular ratio of 10 would be read as  $\frac{10}{15} \times 1.5 = 1$  per cent., and the depth or breadth of the section so determined is the correct result. The value of  $\frac{s}{c}$

from the curves becomes  $\frac{s'}{c} = \frac{m}{15} \cdot \frac{s}{c}$  and  $s' =$  true tensile steel stress  $= \frac{m}{15} s$ . The same remark applies to the algebraical method given under Case II. By choosing the correct percentage curve,  $s'$  can always be given a reasonable value. The curves are drawn for a cover ratio  $k = 0.075$ ; for modifications necessary to allow for a different value, see the general method IV given later; except for estimating purposes the curves there given are to be preferred in all cases other than Case III.

CASE III.—NO STEEL IN COMPRESSION.—The curves drawn for this case (Figs. 121 and 122) are also for  $m = 15$  and  $k = 0.075$ , and are to be used similarly to those given under Case I; for the sake of clearness they have been divided into two ranges. In the lower range (Fig. 121) the value of  $\frac{N^2}{Mbc}$  is to be joined to the origin and the value of  $\frac{N}{bdc}$  read off corresponding to the intersection with the percentage curve used; in the curves for the upper range (Fig. 122), since the origin is off the paper, a secondary bottom horizontal scale marked  $\frac{N^2}{Mbc}$  has been constructed. Joining points on the left vertical or top horizontal to the bottom horizontal scale, the same value of  $\frac{N^2}{Mbc}$  will determine a line, which produced would pass through the origin, and the intersection with the percentage curve can be used as before. These curves can also be used for a different modulus  $m$  in the same way as indicated in Cases I and II; the percentage of steel to be placed is  $\frac{15}{m} \times$  percentage on curve.

The correction for a value of  $k$  differing from 0.075 can be made as follows if required: Using the curves as they stand with  $k = 0.075$ , to find a depth  $d$  corresponding to a breadth  $b$  read off at the same time the value  $\sigma = \frac{s}{c}$ , corresponding to a chosen value of  $p$ , then  $x = \frac{13.85}{\sigma + 15}$  and the variation of the required steel percentage is given by  $\delta p = \left( \frac{a - b}{c - d} \right) \times p$ .

Where  $a = 3 [(1 - k - x) (\frac{1}{2} - k) - 0.425(0.925 - x)] [x^2 + 0.3(1 - k)p]$   
 $b = [1.5x^2 - 2x^3 - 0.9(\frac{1}{2} - k) (1 - k)p] [k - 0.075]$   
 $c = [1.5x^2 - 2x^3 - 0.9(\frac{1}{2} - k) (1 - k)p] [x - (1 - k)]$   
 $d = 3(\frac{1}{2} - k) (1 - k - x) [x^2 + 0.3(1 - k)p]$

FIG. 121.  
[SEE OVERLEAF  
FOR FIG. 122]

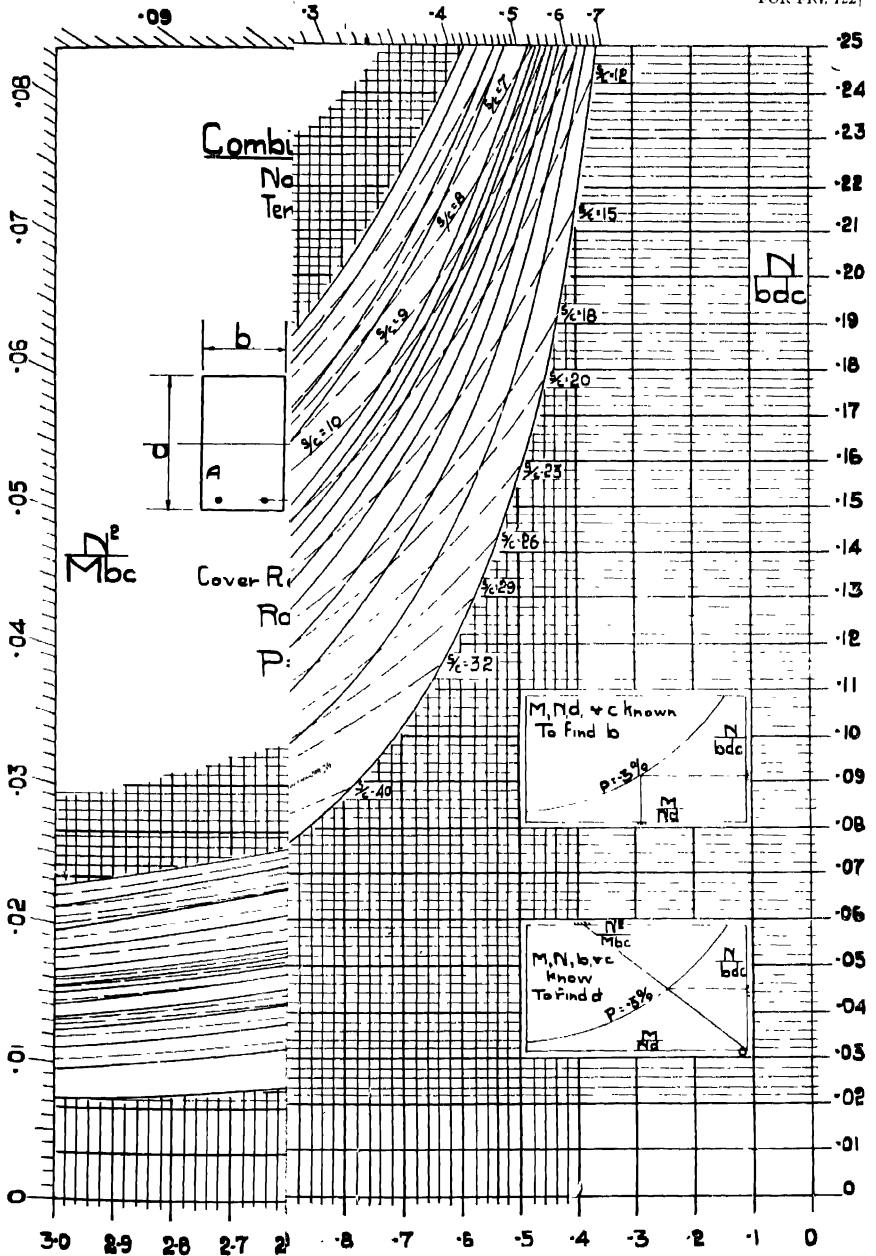
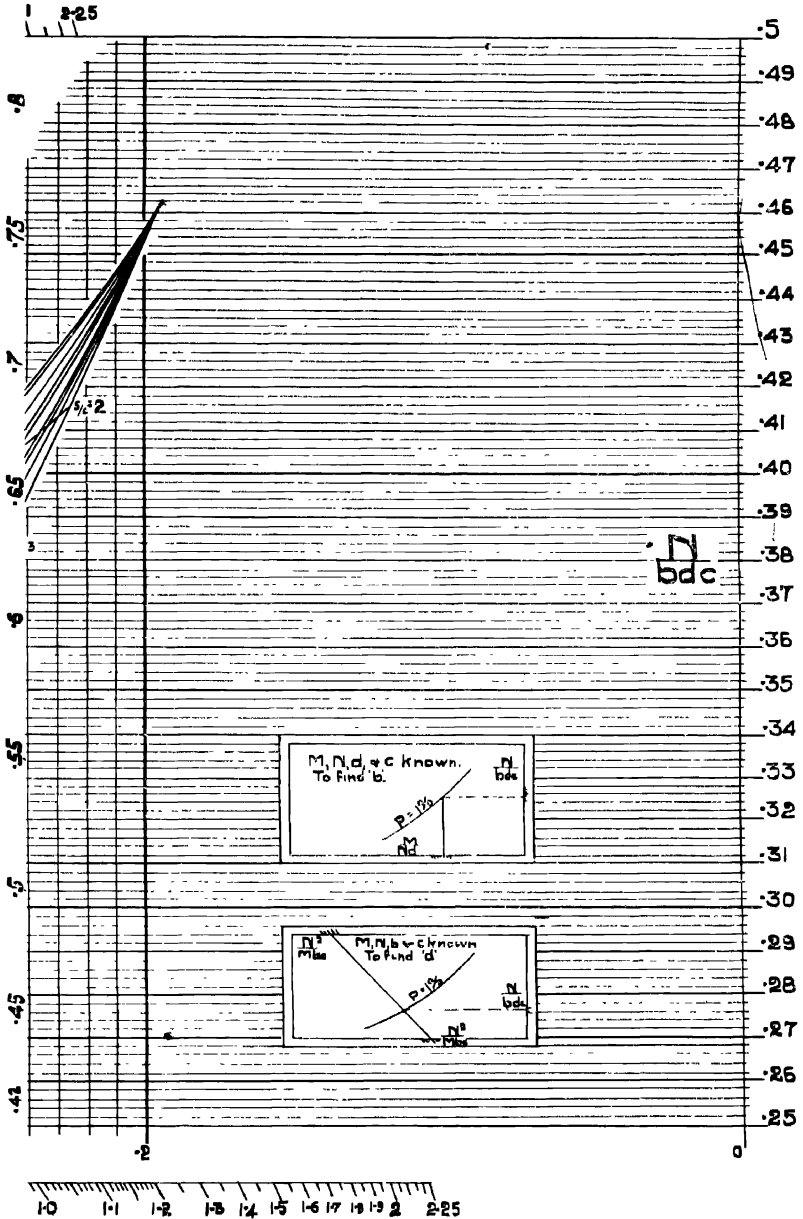

FIG. 122.



Impression Steel.



$$\delta x = \frac{0.3x[(0.075 - k)p + (1 - k - x)\delta p]}{[x^2 + 0.3(1 - k)p]}; \delta \sigma = \frac{15}{x^2}[(0.075 - k)x - (1 - k)\delta x].$$

With  $\sigma' = \sigma + \delta\sigma$ ,  $s' = \sigma'c$ , and  $p' = p + \delta p$ .

The section  $b \times d$  is maintained as found from the curves but with a new steel percentage  $p'$  and steel stress  $s'$ . The same method applies if  $d$  is fixed and  $b$  is to be found. The previous calculation assumes  $m = 15$ , but for any other value the

percentage  $p'$  actually placed is to be read on the curves as  $\frac{m}{15}p'$ , or alternatively by

$p' = \frac{15}{m}p$  = actual percentage to be placed,  $p$  being the curve value. The exact

value of the steel stress is then obtained from the formula  $\sigma'' = \frac{m}{15}\sigma'$ , where  $\sigma'' = \frac{s''}{c}$  or  $s'' = \sigma''c$ .

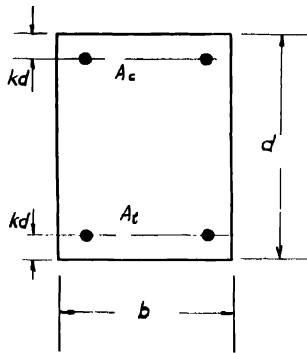

Fig. 123.

It will be seen that the use of these curves is very simple provided allowance has not to be made for a variation of  $k$  from the assumed value 0.075.

GENERAL CASE IV.—Any modulus  $m$ , cover ratio  $k$ , ratio  $r$  of area of compression to tension steel, and tension acting across part of the section (Fig. 123).

$$p = \frac{100(A_c + A_t)}{bd}, \quad r = \frac{A_c}{A_t}$$

$M$  = applied moment about centre line of section

$N$  = applied thrust

$$\sigma = \frac{s}{c} = \text{ratio of steel to concrete stress.}$$

The curves (Figs. 124 to 127) have been drawn (1) with  $\frac{N^2}{b^2d^2c^2}$  as ordinates and  $\frac{M}{bd^2c}$  as abscissæ ( $A$  and  $B$ , Figs. 124 and 125); (2) with  $\frac{N}{bdc}$  as ordinates and  $\frac{M}{bd^2c}$  as abscissæ ( $C$  and  $D$ , Figs. 126 and 127). (The scales of abscissæ are not used and are

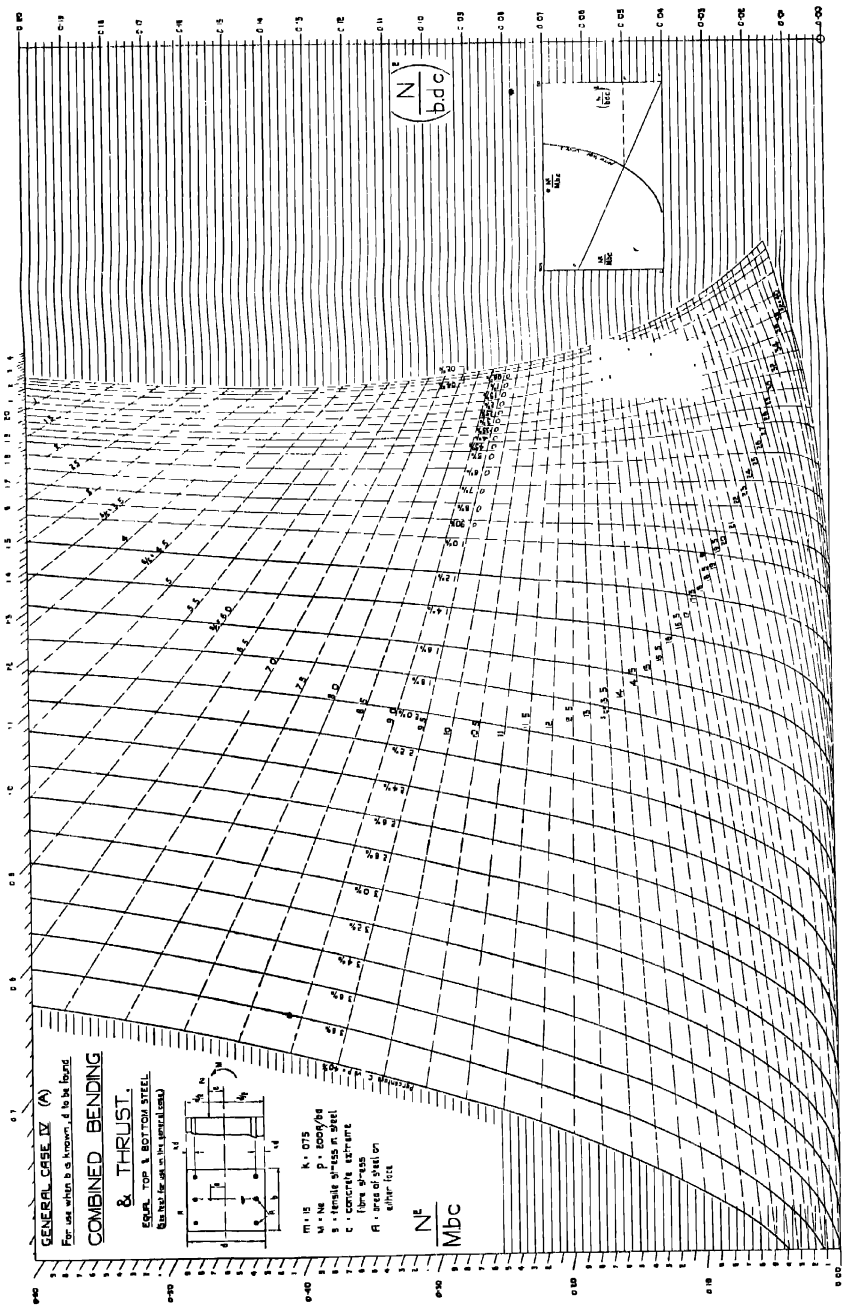
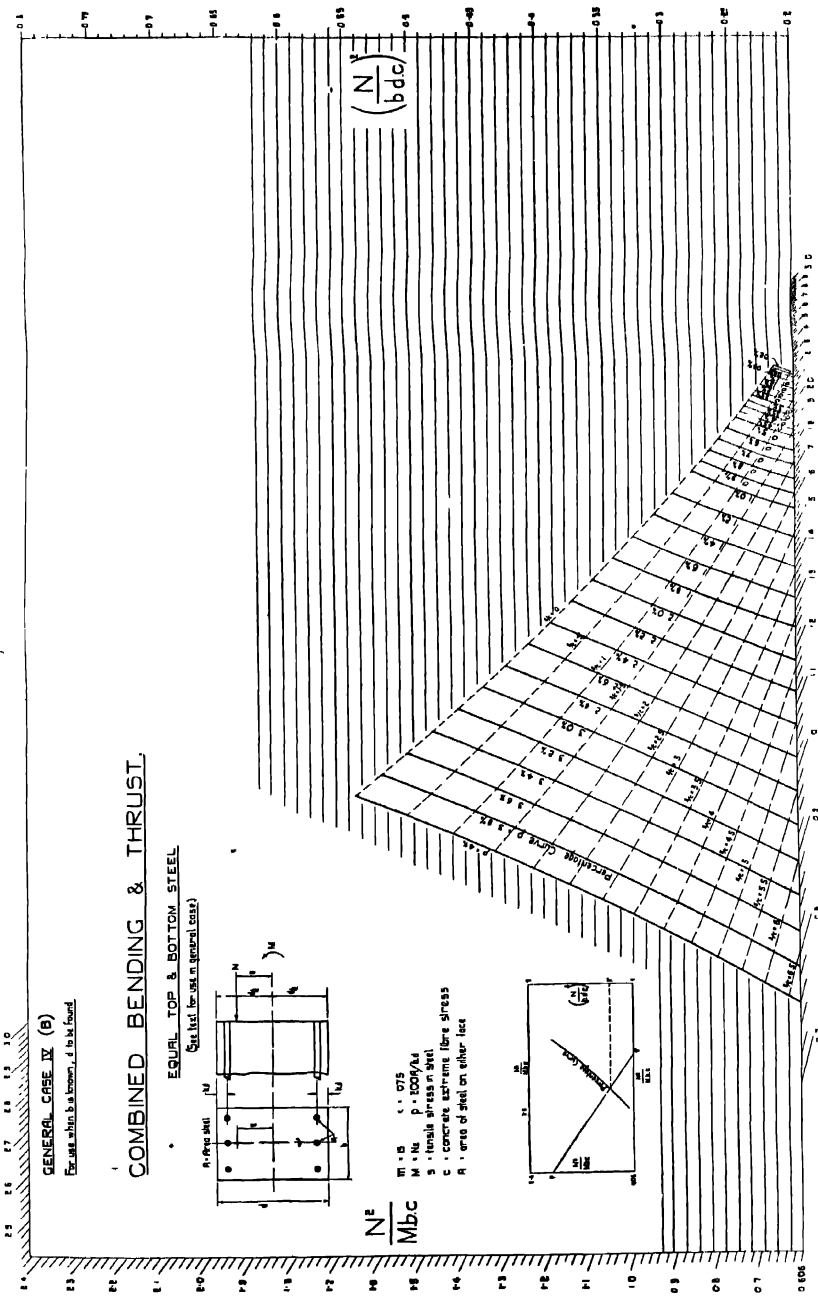

Fig. 124.



**GENERAL CASE IV (B)**  
 For use when  $e$  is known, if to be found

**COMBINED BENDING & THRUST**

**EQUAL TOP & BOTTOM STEEL**  
 (See list for use in general cases)

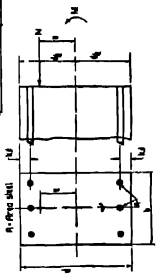

$$\frac{N}{Mbc}$$

- M = 0.075
- N = 10
- p = 100%/A
- S = tensile stress in steel
- C = concrete extreme fibre stress
- A = area of steel on either face

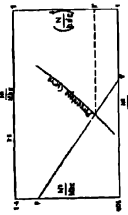

Fig. 125.

therefore not shown.) For clearness curves (1) and (2) are divided into two ranges of  $\frac{N}{bcd}$  and  $\frac{N^2}{b^2d^2c^2}$ . Referring to the lower ranges (curves A and C) it will be seen that the left vertical and top horizontal lines are graduated with the ratios of ordinates to abscissæ, which values are constant on lines drawn to the origin; these ratios are the values of  $\frac{Nd}{M}$  and  $\frac{N^2}{Mbc}$ . Curves (1) therefore enable  $b$  to be fixed for a given value of  $d$  and (2)  $d$  for a given value of  $b$ , since  $\frac{Nd}{M}$  does not contain  $b$  and  $\frac{N^2}{Mbc}$  does not contain  $d$ . In either case the value of  $\frac{Nd}{M}$  or  $\frac{N^2}{Mbc}$  is to be joined to the origin by a straightedge; the intersection with the percentage steel curve chosen gives a value of  $\frac{N}{bcd}$  or  $\frac{N^2}{b^2d^2c^2}$  on the right vertical, from which  $b$  or  $d$  can be found.

In the upper ranges (curves B and D) the same method is employed, but since the origin is off the paper a supplementary bottom horizontal scale of values of  $\frac{Nd}{M}$  or  $\frac{N^2}{Mbc}$  has been added; straightedge lines joining equal values of these expressions on the left vertical or top horizontal to the bottom horizontal will all pass through the origin if produced. In this way any particular  $\frac{Nd}{M}$  or  $\frac{N^2}{Mbc}$  values can be laid down as a straight line, and the intersection with the  $p$  curve gives  $\frac{N}{bcd}$  or  $\frac{N^2}{b^2d^2c^2}$  as before.

Curves are also drawn giving constant values of  $\sigma = \frac{s}{c}$  so that this quantity is known at every intersection of the straightedge line with the chosen  $p$  curve. In this way the tensile steel stress can at once be found.

Case (a)— $r = 1$  or equal steel on both faces with  $k = 0.075$  and  $m = 15$ . The curves can be used as they stand, and  $\sigma = \frac{s}{c}$  is given directly. The results are the same, but more accurate than those obtained from the curves given under Case I.

Case (b)— $r = 1$  but for any modulus  $m$ ,  $k = 0.075$ . Use the curves in the same way but refer to a percentage curve  $\frac{m}{15}p$  where  $p$  is the actual percentage placed.  $s' =$  actual steel stress  $= \frac{m}{15}s$  where  $s$  is found from  $\sigma = \frac{s}{c}$ .

Case (c)— $r = 1$ ,  $m = 15$ ,  $k =$  any value. Determine  $b$ ,  $d$ , and  $\sigma$  from the curves corresponding to a chosen value of  $p$ , then  $x = \frac{13.88}{(\sigma + 15)}$  and the variation in the required steel percentage is

$$\delta p = \frac{3\left[\left(\frac{1}{2} - k\right)^2 - 0.425^2\right] [x^2 + 0.15p]}{[1.5x^2 - 2x^3 - 0.9\left(\frac{1}{2} - k\right)^2p] \left[x - \frac{1}{2}\right] - 3\left(\frac{1}{2} - k\right)^2(x^2 + 0.15p)} \times p.$$

$$\text{Also } \delta x = \frac{0.3x(\frac{1}{2} - x)}{(x^2 + 0.15p)} \times \delta p \quad .$$

$$\text{and } \delta \sigma = \frac{15}{x^2} \{ (0.075 - k)x - (1 - k)\delta x \}$$

$$\sigma' = \sigma + \delta \sigma \text{ and } s' = \sigma'c, p' = p + \delta p.$$

The required alteration in the steel percentage along with the variation in the steel stress are therefore determined.

Alternatively, let  $p$  = percentage to be placed. Calculate  $p' = \frac{5^2(1 - 2k)^2}{4 \cdot 25^2} p$

and find the two curves  $p$  and  $p'$ . Lay down the straightedge line  $OP$  (Fig. 128) and find the  $\sigma$  curve such that the point  $c$  of the right angle triangle  $abc$  lies on  $OP'$ .

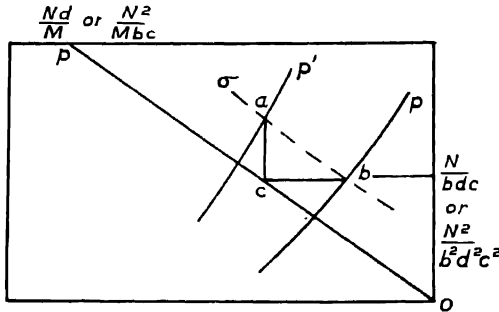

Fig. 128.

Then  $cb$  produced to the right vertical gives the true value of  $\frac{N}{bd^2c}$ , or  $\frac{N^2}{b^2d^2c^2}$ , so that  $b$  or  $d$  can be found. The correct  $\sigma$  curve to satisfy this construction can always be interpolated by eye.

When  $k = 0.05, \quad p' = 1.12 p$   
 $k = 0.075, \text{ case (a)} \quad p' = p \text{ and the curves coalesce}$   
 $k = 0.10, \quad p' = 0.885 p$   
 $k = 0.15, \quad p' = 0.678 p.$

The true value of  $\sigma' = \frac{s'}{c}$  where  $s'$  equals the true steel stress

$$= \left\{ \frac{10(1 - k)(\sigma + 15) - 138.7}{9.25(\sigma + 15) - 138.7} \right\} \sigma,$$

$\sigma$  being read from the curves.

This alternative method is however only of practical use when the curves have been drawn to a larger scale than can be conveniently reproduced in ordinary book form.

Case (d)— $r = 1, m$  any value,  $k$  any value. Modification from (c), exactly as

in case (b) with  $\sigma'' = \frac{m}{15} \sigma'$ .

Case (e)— $r = \frac{1}{2}$ , or one-half as much steel in compression as in tension.  $m = 15$ ,  $k$  any value. Using the curves as they stand, determine  $b$ ,  $d$ ,  $p$  and  $\sigma$ .

Then  $x = \frac{13.88}{(\sigma + 15)}$ . Taking the three coefficients  $\alpha$ ,  $\beta$  and  $\gamma$  from the following table :

|     | $k$   | $\alpha$ | $\beta$ | $\gamma$ |
|-----|-------|----------|---------|----------|
| (a) | 0.05  | 2.78     | 1.50    | 0.650    |
| (b) | 0.075 | 2.52     | 1.42    | 0.642    |
| (c) | 0.10  | 2.27     | 1.33    | 0.633    |
| (d) | 0.15  | 1.81     | 1.17    | 0.617    |

the variation in the steel percentage is given by

$$\delta p = \frac{(\gamma - \frac{1}{2})(15x^2 - 20x^3 - 0.9p\alpha) + 3(\alpha - 1.8 - \beta x)(x^2 + 0.3p\gamma)}{(x - \gamma)(15x^2 - 20x^3 - 0.9p\alpha) - 3(\alpha - \beta x)(x^2 + 0.3p\gamma)} \times p$$

$$\delta x = \frac{0.3\{p(\gamma - \frac{1}{2}) + (\gamma - x)\delta p\}x}{(x^2 + 0.3p\gamma)}$$

$$\delta \sigma = \frac{15}{x^2} \{(0.075 - k)x - (1 - k)\delta x\}$$

with  $\sigma' = \sigma + \delta\sigma$ , and  $s' = \sigma'c$ ,  $p' = p + \delta p$ .

Case (f)— $r = \frac{1}{2}$ ,  $m$  any value,  $k$  any value. This modification from (e) is to be dealt with exactly as under (d),  $p$  being read throughout as  $\frac{m}{15}p$  and being the actual percentage used.

Case (g)— $r = 2$ , or twice as much steel in compression as in tension. This case is dealt with exactly as for (e) and (f) except that  $\alpha$ ,  $\beta$ , and  $\gamma$  are as follows :

| $k$   | $\alpha$ | $\beta$ | $\gamma$ |
|-------|----------|---------|----------|
| 0.05  | 1.275    | 1.5     | 0.350    |
| 0.075 | 1.098    | 1.42    | 0.358    |
| 0.10  | 0.933    | 1.33    | 0.367    |
| 0.15  | 0.642    | 1.17    | 0.383    |

Case (h)— $r = \frac{1}{4}$ , or one-quarter as much steel in compression as in tension. As for case (g) but  $\alpha$ ,  $\beta$ , and  $\gamma$  are as follows :

| $k$   | $\alpha$ | $\beta$ | $\gamma$ |
|-------|----------|---------|----------|
| 0.05  | 3.375    | 2.7     | 0.77     |
| 0.075 | 3.081    | 2.55    | 0.755    |
| 0.10  | 2.800    | 2.40    | 0.74     |
| 0.15  | 2.275    | 2.10    | 0.71     |

Case (j)— $r = 0$ , or no steel in compression. This case has been dealt with directly by means of curves under Case III.

VERIFICATION OF STRESSES IN A GIVEN SECTION (Fig. 129) —

$$p = \frac{100(A_c + A_t)}{bd}, \quad r = \frac{A_c}{A}$$

$$e = \frac{M}{Nd}, \quad m = \text{modular ratio}$$

$M$  = moment about the centre line of section

$N$  = applied thrust

$$x = \frac{1}{2} - e + \frac{1}{10}(\beta + \sqrt{\beta^2 - \alpha^3})^{\frac{1}{2}} + \frac{1}{10}(\beta - \sqrt{\beta^2 - \alpha^3})^{\frac{1}{2}}$$

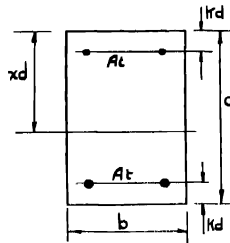

Fig. 129.

where 
$$\alpha = 25(2e - 1)^2 \cdot mp \left( 2e + \frac{(1-r)(1-2k)}{(1+r)} \right)$$

$$\beta = \frac{3mp}{(1+r)} [5(2e - 1)((1+r)e + \frac{1}{2}(1-r)(1-2k)) + 10(1 - (1-r)k)e + 5(1 - (1+r)k)(1 - 2k)] - 125(2e - 1)^3.$$

The external fibre concrete stress is given by

$$\left\{ \frac{1}{2}x + \frac{mp}{100(1+r)} \left( (1+r) - \frac{(1 - (1-r)k)}{x} \right) \right\} \frac{N}{bd}$$

and the tensile steel stress by

$$s = \frac{mc(1 - x - k)}{x}$$

Case (a)—Equal steel on two faces ( $r = 1$ ):

$$\alpha = 25(2e - 1)^2 - 2mpe$$

$$\beta = (30e^2 + 7.5(1 - 2k)^2)mp - 125(2e - 1)^3.$$

Case (b)—No steel in compression ( $r = 0$ ):

$$\alpha = 25(2e - 1)^2 - mp(2e + 1 - 2k)$$

$$\beta = (30e^2 + 30(1 - 2k)e + 7.5(1 - 2k)^2)mp - 125(2e - 1)^3.$$

Case (c)— $r = \frac{1}{2}$  or one-half steel in compression as in tension :

$$\alpha = 25(2e - 1)^2 - mp(2e + \frac{1}{3}(1 - 2k))$$

$$\beta = (30e^2 + 10(1 - 2k)e + 7.5(1 - 2k)^2)mp - 125(2e - 1)^3.$$

Case (d)— $r = \frac{1}{4}$  or one-quarter steel in compression as in tension :

$$\alpha = 25(2e - 1)^2 - mp(2e + \frac{3}{5}(1 - 2k))$$

$$\beta = (30e^2 + 18(1 - 2k)e + 7.5(1 - 2k)^2)mp - 125(2e - 1)^3.$$

GENERAL CASE,  $m$ ,  $r$ , AND  $k$  ANY VALUE ; ONLY COMPRESSION ACTING OVER SECTION.—

Let  $M$  = applied moment about centre line of section

$N$  = applied thrust

$$p = \frac{100(A_c + A_c')}{bd}, \quad r = \frac{A_c}{A_c'}$$

$c$  = maximum unit compression in concrete.

The depth  $d$  for a given breadth is given by the positive root of the quadratic  $Ad^2 - Bd - C = 0$  where

$$A = bc \left[ \left( 1 + \frac{mp}{100} \right) \left( \frac{mp[1 - k(r + 1)](\frac{1}{2} - k)}{100(r + 1)} + \frac{1}{12} \right) \right. \\ \left. + \left( \frac{mp(r - 1)(\frac{1}{2} - k)}{100(r + 1)} \right) \left( \frac{mp[1 + (r - 1)k]}{100(r + 1)} + \frac{1}{2} \right) \right]$$

$$B = \left[ \frac{mp[1 - k(r + 1)](\frac{1}{2} - k)}{100(r + 1)} + \frac{1}{12} \right] N$$

$$C = \left[ \frac{mp[1 - (1 - r)k]}{100(r + 1)} + \frac{1}{2} \right] M.$$

For equal steel on both faces ( $r = 1$ ) the solution of the quadratic with  $k = 0.075$  and  $m = 15$  gives

$$d = \frac{N}{2bc(1 + 0.15p)} \left\{ 1 + \sqrt{\frac{24Mbc}{N^2} \times \alpha} \right\}$$

where  $\alpha$  is a constant which can usually be taken equal to 1 ; its values for different percentages are as follows :

| $p$ (per cent.) | $\alpha$ |
|-----------------|----------|
| 1               | 1.00     |
| 1.5             | 1.01     |
| 2               | 1.025    |
| 2.5             | 1.045    |
| 3               | 1.06     |
| 3.5             | 1.09     |
| 4               | 1.11     |

Also

$$b = \frac{N}{cd(1 + 0.15p)} + \frac{6M\alpha}{cd^2(1 + 0.15p)^2}$$



When  $r = 2$ , or there is twice as much steel on the more compressed side than on that less compressed,  $u$  is given by  $Ad^2 - Bd - C = 0$ , where

$$A = \left[ \left( 1 + \frac{mp}{100} \right) \left( \frac{mp(1-3k)(\frac{1}{2}-k)}{300} + \frac{1}{12} \right) + \frac{mp(\frac{1}{2}-k)}{300} \left( \frac{mp(1+k)}{300} + \frac{1}{2} \right) \right] bc,$$

$$B = \left[ \frac{mp(1-3k)(\frac{1}{2}-k)}{300} + \frac{1}{12} \right] N \quad \text{and} \quad C = \left[ \frac{mp(1+k)}{300} + \frac{1}{2} \right] M.$$

When  $m = 15$  and  $k = 0.075$ :

$$A = \left[ \frac{1}{12} (1 + 0.15p) (1 + 0.198p) + 0.011 (1 + 0.108p) p \right] bc,$$

$$B = \frac{1}{12} (1 + 0.15p) (1 + 0.198p) N, \quad \text{and} \quad C = \frac{1}{2} (1 + 0.108p) M.$$

Other cases can be worked out from the general formulæ.

CASE V.—COMBINED BENDING AND THRUST ON CIRCULAR OR POLYGONAL SECTIONS (Fig. 130).—The curves (Fig. 131) given for this case assume that the steel is concentrated at the extremities of the core diameter. This is the usual case, since in bridge members bending occurs only in one plane; the main steel should therefore be placed on a diameter and not distributed around the section. Since such sections are usually hooped to give a high concrete stress the concrete outside the core is neglected.

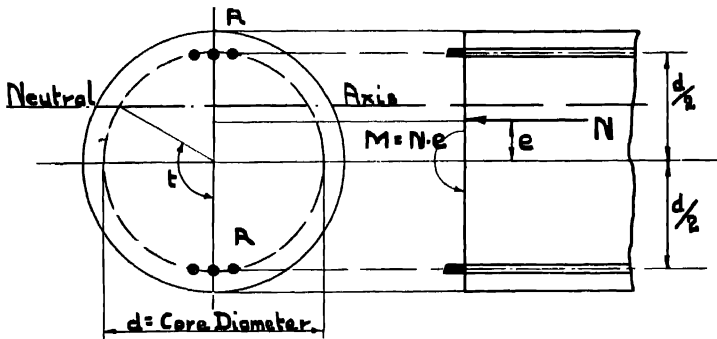

$$p = \frac{1000A}{\pi d^2} = \text{Total Steel Percentage.}$$

$A$  = Area of Steel in Each Face.

Fig. 130.

The curves give simultaneous values of  $\frac{N}{d^2c}$ ,  $\frac{M}{d^3c}$ ,  $p$  and  $\frac{s}{c}$ . A scale of  $\frac{M}{Nd}$  is shown along the left-hand vertical and the top horizontal. To use the curves assume  $d$ , calculate  $\frac{M}{Nd}$ , and lay off a straight line from this value to the origin at the bottom right-hand corner; where this line cuts any chosen  $p$  or  $\frac{s}{c}$  curve, the value of  $\frac{N}{d^2c}$  is read, from which  $c$  and  $s$  can be calculated. Two trial values of  $d$  usually give the desired stresses.

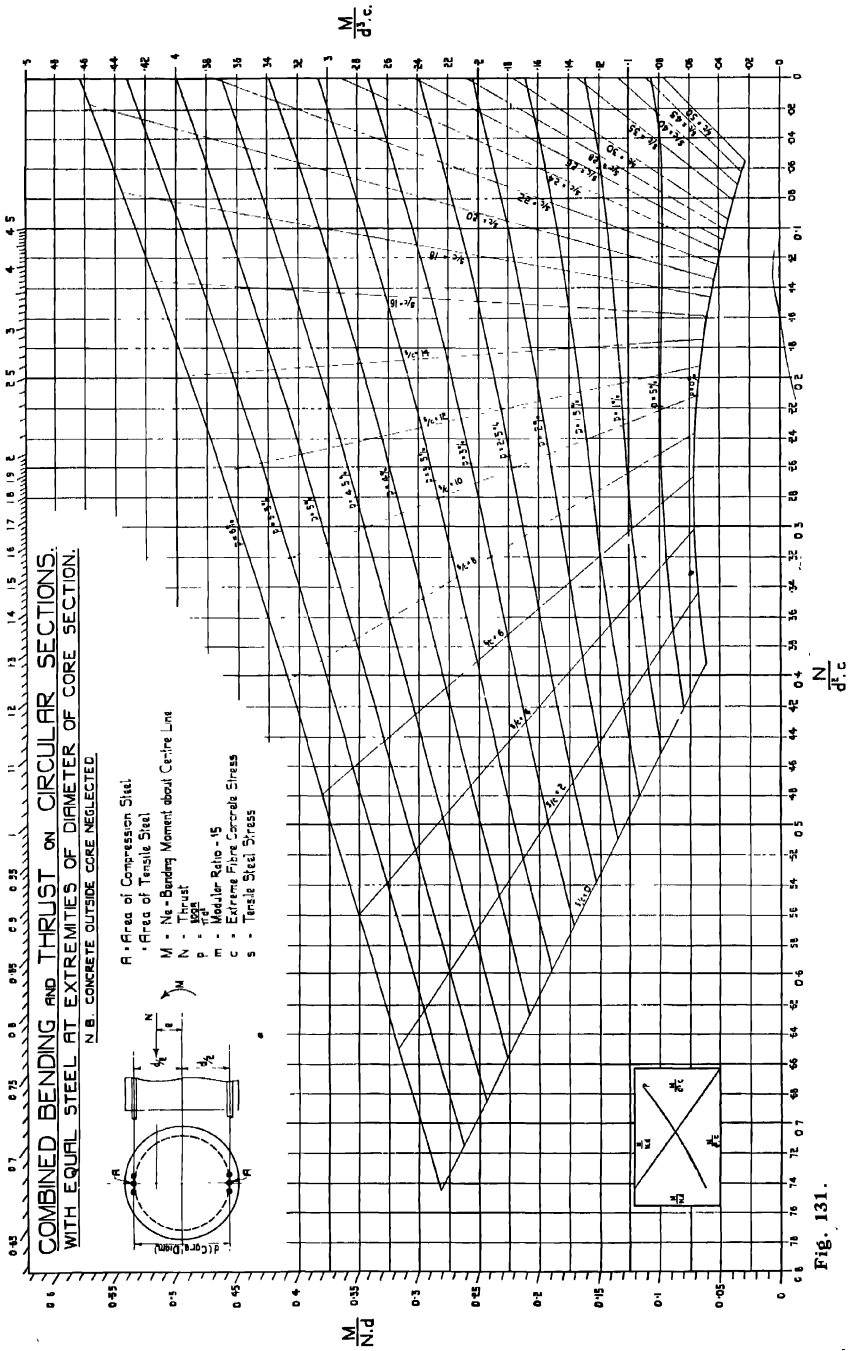

Fig. 131.

By the addition of curves giving the ratio of  $\left(\frac{N}{d^2c}\right)^3$  or  $\frac{N}{M^2c}$  for constant  $\left(\frac{M}{d^3c}\right)^2$

values, the system of curves could be used to give  $d$  immediately, without trial, for an assumed concrete stress, but this appears to be an unnecessary complication.

The curves are drawn for a ratio of moduli equal to 15. For any other ratio ( $m$ ) the curves can be used in exactly the same way but,  $p$  being the percentage written against the curve found to give a correct value for  $c$ , the actual steel to be placed is  $p' = \frac{15}{m}p$  and the true value of  $\frac{s}{c} = \frac{m}{15} \times$  value of  $\frac{s}{c}$  on the curves.

In the case where only compression acts across the section, the maximum concrete stress is given by the formula

$$c = \frac{1}{\pi d^2} \left\{ \frac{800M}{(25 + mp)d} + \frac{400N}{(100 + mp)} \right\}$$

with a steel stress  $s = mc$ ,  $p$  being the total steel percentage as before.

Example 1.-  $M = 54,000,000$  in. lb.;  $N = 1,800,000$  lb.; rectangular section with  $b = 96$  in.;  $p = 0.3$  per cent.;  $c = 600$  lb. per square inch;  $m = 15$ ;  $k = 0.075$ . Reinforcement equal on two faces. It is required to determine  $d$ . In this case

$$\frac{N^2}{Mbc} = \frac{(1,800,000)^2}{54,000,000 \times 96 \times 600} = 1.04.$$

Using the curves for Case IV ( $A$ ), a diagonal from 1.04 to the origin cuts the curve  $p = 0.3$  per cent. at a point giving

$$\left(\frac{N}{bdc}\right)^2 = 0.108 \text{ and } \sigma = \frac{s}{c} = 6.70.$$

Then 
$$d = \frac{N}{bc\sqrt{0.108}} = \frac{1,800,000}{96 \times 600 \times 0.329} = 95 \text{ in.}$$

The steel stress  $s = 6.70 \times 600 = 4020$  lb. per square inch, and the steel area  $= 2A = 0.3 \times 96 \times \frac{95^2}{100} = 27.4$  sq. in., or  $A = 13.7$  sq. in. on each face.

Example 2.-  $M = 54,000,000$  in. lb.;  $N = 1,800,000$  lb.; rectangular section with  $d = 95$  in.;  $p = 0.3$  per cent.;  $c = 600$  lb. per square inch;  $m = 15$ ;  $k = 0.075$ . Reinforcement equal on two faces. It is required to determine  $b$ .

$$\frac{Nd}{M} = \frac{1,800,000 \times 95}{54,000,000} = 3.165.$$

Using the curves for Case IV ( $C$ ), a diagonal from 3.165 to the origin cuts the curve  $p = 0.3$  per cent. at a point giving  $\frac{N}{bdc} = 0.329$  and  $\sigma = 6.7$ . Then

$$b = \frac{N}{0.329 \times dc} = \frac{1,800,000}{0.329 \times 95 \times 600} = 96 \text{ in.}$$
 As in Example 1,  $s = 4020$  lb. per square inch;  $2A = 27.4$  sq. in.

Example 3.— $M = 54,000,000$  in. lb. ;  $N = 1,800,000$  lb. ; rectangular section with  $b = 96$  in. ;  $p = 0.3$  per cent. ;  $c = 1200$  lb. per square inch ;  $m = 10$  ;  $k = 0.075$ . Reinforcement equal on two faces. To determine  $d$  we have

$$\frac{N^2}{Mbc} = \frac{(1,800,000)^2}{54,000,000 \times 96 \times 1200} = 0.52.$$

Since the modulus is 10, the percentage curve to be used corresponding to  $p = 0.3$  per cent. actually to be placed is

$$p' = \frac{10}{16} \times 0.3 = 0.2 \text{ per cent.}$$

Using the curves for Case IV (A), a diagonal from 0.52 to the origin cuts the curve  $p = 0.2$  per cent. at a point giving

$$\left(\frac{N}{bdc}\right)^2 = 0.047 \text{ and } \sigma = \frac{s}{c} = 16.5.$$

Then  $d = \frac{N}{bc\sqrt{0.047}} = \frac{1,800,000}{96 \times 1200 \times 0.217} = 72$  in., requiring a section 96 in. by 72 in.

$s = \frac{10}{16} \times 16.5 \times 1200 = 13,200$  lb. per square inch, and the steel area

$$= 2A = 0.3 \times 96 \times 72 = 20.8 \text{ sq. in.}$$

$\therefore A = 10.4$  sq. in. on each face.

Example 4.— $M = 54,000,000$  in. lb. ;  $N = 1,800,000$  lb. ; rectangular section with  $d = 72$  in. ;  $p = 0.3$  per cent. ;  $c = 1200$  lb. per square inch ;  $m = 10$  ;  $k = 0.075$ . Reinforcement equal on two faces. To determine  $b$  we find

$$\frac{Nd}{M} = \frac{1,800,000 \times 72}{54,000,000} = 2.4.$$

As in Example 3, the curve  $p = \frac{10}{16} \times 0.3 = 0.2$  per cent. is to be used. Using the curves for Case IV (C) a diagonal from 2.4 to the origin cuts the curve  $p = 0.2$  per cent. at a point giving  $\frac{N}{bdc} = 0.217$  and  $\sigma = \frac{s}{c} = 16.5$ .

Then  $b = \frac{N}{0.217 \times dc} = \frac{1,800,000}{0.217 \times 72 \times 1200} = 96$  in., requiring a section 96 in. by 72 in. as before.

$\frac{s}{c} = 13,200$  lb. per square inch and  $2A = 20.8$  sq. in. as in Example 3.

Example 5.— $M = 54,000,000$  in. lb. ;  $N = 1,800,000$  lb. ; rectangular section with  $b = 96$  in. ;  $p = 0.15$  per cent. ;  $c = 600$  lb. per square inch ;  $m = 15$  ;  $k = 0.075$ . Reinforcement on tension face only. To determine  $d$  we have

$$\frac{N^2}{Mbc} = \frac{(1,800,000)^2}{54,000,000 \times 96 \times 600} = 1.04.$$

Using curves III (B) (Fig. 122) a line from 1.04 on the top and bottom horizontals would cut  $p = 0.15$  per cent. at a point giving  $\frac{N}{bdc} = 0.316$  (interpolating

between 0.1 per cent. and 0.2 per cent. by eye) ;  $\sigma = \frac{s}{c} = 6.4$ .

Then 
$$d = \frac{N}{bc \times 0.316} = \frac{1,800,000}{96 \times 600 \times 0.316} = 99 \text{ in.}$$

$$s = 6.4 \times 600 = 3840 \text{ lb. per square inch.}$$

$$A = 0.15 \times 99 \times 96 = 14.25 \text{ sq. in.}$$

If  $p$  be made 0.3 per cent., giving the same percentage on one face as the two faces in Example 1, then  $\frac{N}{bdc} = 0.322$  is given by the intersection of the same diagonal with  $p = 0.3$  per cent. Also  $d = \frac{N}{0.322bc} = \frac{1,800,000}{96 \times 600 \times 0.322} = 97$  in compared with 95 in. in Example 1.

$s = 5.5 \times 600 = 3300$  lb. per square inch.  
 $A = 0.3 \times 96 \times 97 = 28$  sq. in. compared with 27.4 sq. in. in Example 1.

Example 6.— $M = 54,000,000$  in. lb. ;  $N = 1,800,000$  lb. ; rectangular section with  $b = 96$  in. ;  $p = 0.15$  per cent. ;  $c = 1200$  lb. per square inch ;  $m = 10$  ;  $k = 0.075$ . Reinforcement on one face only. To determine  $d$  we have

$$\frac{N^2}{Mbc} = \frac{(1,800,000)^2}{54,000,000 \times 96 \times 1200} = 0.52.$$

Using the curves for Case III (A) (Fig. 121), a line from 0.52 to the origin cuts  $p' = 0.1$  per cent. at a point giving  $\frac{N}{bdc} = 0.212$ ,  $p'$  being taken  $= \frac{1}{16} \times 0.15 = 0.1$  per cent. In this case  $\sigma = \frac{s}{c} = 15.5$ .

Then 
$$d = \frac{N}{bc \times 0.212} = \frac{1,800,000}{96 \times 1200 \times 0.212} = 74 \text{ in.}$$

$$s = \frac{1}{16} \times 15.5 \times 1200 = 12,400 \text{ lb. per square inch.}$$

$$A = 0.15 \times 96 \times 74 = 10.7 \text{ sq. in. on the tension face.}$$

If a percentage  $p = 0.3$  per cent. is used (being the same amount on one face as on the two faces in Example 3) then  $p' = \frac{1}{16} \times 0.3 = 0.2$  per cent.,

$$\frac{N}{bdc} = 0.222 \text{ and } \sigma = \frac{s}{c} = 12.75 \text{ from the curves.}$$

$\therefore d = \frac{1,800,000}{96 \times 1200 \times 0.222} = 70\frac{1}{2}$  in. as against 72 in. in Example 3.

Also  $s = \frac{1}{16} \times 12.75 \times 1200 = 10,200$  lb. per square inch, and  
 $2A = 0.3 \times 96 \times 70.5 = 20.3$  sq. in.

Example 7.—The conditions being as in Example 1, but with  $k = 0.15$  in place of 0.075, it is required to determine the alteration in percentage of steel required to give the same section of 96 in. by 95 in. with the assumed concrete stress  $c = 600$  lb. per square inch, and to find the altered steel stress.

Using the formulæ [General Case IV (C)],

$$x = \frac{13.88}{\sigma + 15} = \frac{13.88}{6.7 + 15} = 0.64, \quad p = 0.3 \text{ per cent.}$$

$$\begin{aligned}
 3\left[\left(\frac{1}{2} - k\right)^2 - 0.425^2\right][x^2 + 0.15p] &= -3 \times 0.0581 \times 0.455 = -0.0793 \\
 [1.5x^2 - 2x^3 - 0.9\left(\frac{1}{2} - k\right)^2p][x - \frac{1}{2}] &= 0.057 \times 0.14 = 0.008 \\
 3\left(\frac{1}{2} - k\right)^2(x^2 + 0.15p) &= 3 \times 0.35^2 \times 0.455 = 0.167.
 \end{aligned}$$

$$\text{Then } \delta p = \frac{-0.0793}{0.008 - 0.167} p = 0.50p - 0.50 \times 0.3 = 0.15, \text{ and the corrected}$$

percentage is  $p' = p + \delta p = 0.3 + 0.15 = 0.45$  per cent.

$$\text{Also } 0.3x\left(\frac{1}{2} - x\right) = -0.3 \times 0.64 \times 0.14 = -0.0269,$$

$$x^2 + 0.15p = 0.455,$$

$$\delta x = -\frac{0.0269}{0.4550} \times 0.15 = -0.00887,$$

$$\delta \sigma = \frac{15}{0.64^2} \{(0.075 - 0.15)0.64 + 0.85 \times 0.00887\} = -1.48.$$

$\therefore \sigma' = 6.7 - 1.48 = 5.22$ , and  $s' = 600 \times 5.22 = 3130$  lb. per square inch. And  $2A = 0.450 \times 96 \times \frac{9.5}{100} = 41$  sq. in., or  $20.5$  sq. in. on each face.

The section 96 in. by 95 in. with  $k = 0.15$  is to be reinforced with 20.5 sq. in. of steel in each face with a stress of 3140 lb. per square inch, in place of a section 96 in. by 95 in. with  $k = 0.075$ , reinforced with 13.7 sq. in. of steel in each face with a stress of 4020 lb. per square inch.

Example 8.--To verify the stresses in the section determined in Example 1, we find

$$e = \frac{M}{Nd} = \frac{54,000,000}{1,800,000 \times 95} = 0.316.$$

Using the formulæ for verification of Case (a), we have

$$\begin{aligned}
 \alpha &= 25(2e - 1)^2 - 2mpe = 25(0.632 - 1)^2 - 30 \times 0.3 \times 0.316 = 0.542; \\
 \beta &= [30e^2 + 7.5(1 - 2k)^2]mp - 125(2e - 1)^3 = 44.09;
 \end{aligned}$$

$$\therefore (\beta + \sqrt{\beta^2 - \alpha^3})^{\frac{1}{3}} = 4.451 \text{ and } (\beta - \sqrt{\beta^2 - \alpha^3})^{\frac{1}{3}} = 0.1218.$$

$$\text{Also } x = \frac{1}{2} - e + \frac{1}{10} [(\beta + \sqrt{\beta^2 - \alpha^3})^{\frac{1}{3}} + (\beta - \sqrt{\beta^2 - \alpha^3})^{\frac{1}{3}}] = 0.6413.$$

$$\therefore c = \frac{1,800,000}{\left[\frac{1}{2}x + \frac{mp}{200}\left(2 - \frac{1}{x}\right)\right]bd} = \frac{1,800,000}{3015} = 598 \text{ lb. per square inch as against}$$

600 lb. per square inch assumed.

$$s = \left(\frac{1 - x - k}{x}\right)mc = \left(\frac{1 - 0.6413 - 0.075}{0.6413}\right)15 \times 598 = 3970 \text{ lb. per square inch against 4020 lb. per square inch found.}$$

In the modified case Example 7 with  $k = 0.15$  and  $p = 0.45$ ,

$$\therefore \alpha = -0.8804 \text{ and } \beta = 51.26.$$

$$\therefore (\beta + \sqrt{\beta^2 - \alpha^3})^{\frac{1}{3}} = 4.680 \text{ and } (\beta - \sqrt{\beta^2 - \alpha^3})^{\frac{1}{3}} = -0.188.$$

$$x = \frac{1}{2} - 0.316 + 0.4492 = 0.6332.$$

$$\therefore c = \frac{1,800,000}{3016} = 598 \text{ lb. per square inch, as against 600 lb. per square inch assumed.}$$

$s = \left( \frac{1 - 0.6332 - 0.15}{0.6331} \right) 15 \times 598 = 3070$  lb. per square inch in place of 3140 lb. per square inch found.

Example 9.— $M = 54,000,000$  in. lb. ;  $N = 1,800,000$  lb. ; rectangular section with  $b = 96$  in. and  $d = 95$  in. having twice the area of steel in compression as in tension ;  $c = 600$  lb. per square inch ;  $m = 15$  ; and  $h = 0.075$ . To determine  $p'$ , the total steel percentage, and the steel stress.

From Example 1,  $p = 0.3$  per cent. ;  $\alpha = 1.098$  ;  $\beta = -1.42$  ; and

$$\gamma = 0.358. \text{ Also } x = \frac{13.88}{6.7 + 15} = 0.64.$$

$$\begin{aligned} \therefore (\gamma - \frac{1}{2})(15x^2 - 20x^3 - 0.9p\alpha) &= -0.087, \\ 3(\alpha - 1.8 - \beta x)(x^2 + 0.3p\gamma) &= 0.2745, \\ (x - \gamma)(15x^2 - 20x^3 - 0.9p\alpha) &= 0.173, \\ 3(\alpha - \beta x)(x^2 + 0.3p\gamma) &= 2.67. \end{aligned}$$

$$\delta p = \frac{-0.087 + 0.2745}{0.173 - 2.67} \times 0.3 = -0.0225, \text{ and } p' = \text{required percentage}$$

$$= 0.3 - 0.0225 = 0.2775.$$

$$\begin{aligned} 0.3[p(\gamma - \frac{1}{2}) + (\gamma - x)\delta p]x &= -0.00695, \\ [x^2 + 0.3p\gamma] &= 0.4418, \end{aligned}$$

$$\delta x = \frac{-0.00695}{0.4418} = -0.0157$$

$$\delta \sigma = \frac{15 \times 0.925 \times 0.0157}{0.642} = 0.532$$

$$\therefore \sigma' = \sigma + \delta \sigma = 7.23$$

$s' =$  tensile steel stress  $= 7.23 \times 600 = 4340$  lb. per square inch. In this case there is a reduction in the percentage of steel required as compared with the same section having equal steel on the two faces. The total steel required is

$A_c + A_t = \frac{0.2775 \times 95 \times 96}{100} = 25.3$  sq. in., say, 8.5 sq. in. in tension and 17 sq. in. in compression.

Example 10.— $M = 35,000,000$  in. lb. ;  $N = 1,000,000$  lb. ; octagonal section with hooped core ;  $c = 2000$  lb. per square inch (allowing for hooping) ; and  $m = 10$ . It is required to determine the diameter corresponding to  $p' = 3$  per cent. of steel placed on a diameter.

Since  $m = 10$ , the curve value of  $p$  to be used is

$$p = 3 \times \frac{10}{15} = 2 \text{ per cent.}, \text{ and assuming } d = 48 \text{ in.}$$

$$\frac{M}{Nd} = \frac{35,000,000}{1,000,000 \times 48} = 0.730.$$

A diagonal joining the point 0.73 to the origin cuts the curve  $p = 2$  per cent.

at a point where  $\frac{N}{d^2c} = 0.219$  ;  $\frac{s}{c} = 11.8$ .

Then  $c = \frac{1,000,000}{48^2 \times 0.219} = 1980$  lb. per square inch, and

$$s = \frac{1}{1.5} \times 11.8 \times 1980 = 15,600 \text{ lb. per square inch.}$$

The steel area is  $2A = \frac{\pi \times 48^2 \times 3}{400} = 54$  sq. in., or 27 sq. in. on each side.

The diameter overall allowing 6 in. for cover is  $d = 48$  in. + 6 in. = 4 ft. 6 in.



## CHAPTER VII

### DESIGN OF ARCHES

In ordinary cases only three types of reinforced concrete arches require consideration, namely, (1) the three-hinged type, (2) arches without hinges, and (3) the bowstring type.

The first is specially applicable where settlement of the foundations may be anticipated, and would not generally be chosen in the cases where rock or firm boulder clay could be reached. Since the ground conditions are not usually favourable where the three-hinged type is employed, a framed superstructure with columns or cross walls, beams, and deck slab is the best construction to lighten the foundation loading; where, however, the rise of the arch is unusually small relative to the span, a solid earth filling without superstructure may prove more economical.

A three-hinged arch with the quarter-point thicknesses greater than the springing thicknesses is not always attractive in appearance, and the line of the extrados may be masked by thin spandrel walls extending to road level; the hinges are usually difficult to mask, and it is probably best to show them. Although the three-hinged type with mask walls and hollow superstructure is the best for comparatively poor foundations, there is no objection to the use of a three-hinged arch with solid filling for small or medium rises, between foundations on rock or boulder clay.

Three-hinged arches are generally constructed in the barrel form, although isolated ribs can be used. The barrel form is specially convenient in allowing the use of bar hinges, the total thrusts being resisted by reinforcement projecting on each side into the concrete far enough to develop the full stress in the steel. Such hinges have proved satisfactory, and their use makes unnecessary the special cast-iron or steel hinges required in the case of three-hinged rib arches and which are usually an expensive item.

The three-hinged arch is specially applicable to cases where it is desired to avoid the use of falsework in rivers subject to severe flooding. In these cases the reinforcement may consist of structural steelwork from which the falsework may be hung, the hinges allowing easy erection of the steel when working from both banks of the river.

The hingeless type of arch is the usual form of arched construction, but should only be employed where very firm ground can be reached directly or on piled foundations. The construction is simpler than the three-hinged type, and the resulting form of the arch satisfies all æsthetic requirements without any masking being required. There are two main types: (*a*) The solid-filled barrel-arch type, which is the best for small rises, and (*b*) The barrel-arch or isolated-rib type with an open superstructure, which is more adapted to medium and

high rise-span ratios. In general the ribbed type is most economical and lends itself to high concrete stresses with spiral reinforcement.

The solid-filled type should never be employed for high rise-span ratios, since the spandrel walls become unnecessarily heavy and expensive to construct and the additional foundation loading is relatively considerable.

One of the chief objections to the use of the hingeless type, namely the unnecessarily tedious calculations for moving point loads, no longer applies; regulations now allow the use of distributed moving loads with only a single concentration, and the calculations are relatively simple.

The third type, or bowstring, is a special form of construction in which main ribs rise above the deck level and support the deck by means of hanging columns. It is often employed and is, indeed, the only type possible for single spans where the headroom under an ordinary arched construction would be insufficient. In this type the arch thrusts are taken by tension steel reinforcing longitudinal ribs at deck level. The forces on the abutments can therefore

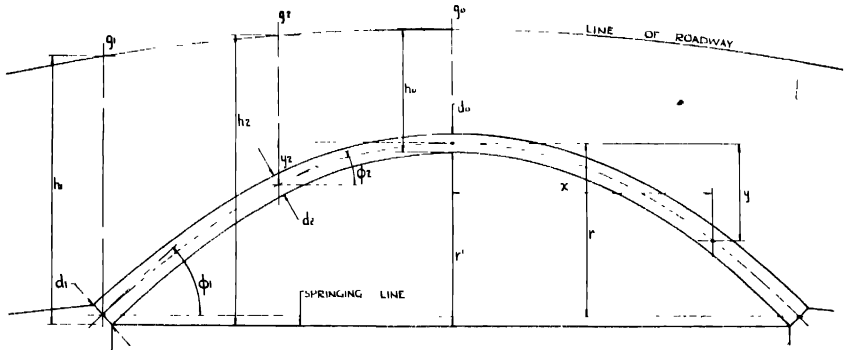

Fig. 132.

be made vertical by the use of sliding or rolling supports, and considerable saving in the foundations results from the absence of horizontal thrusts.

It would seem that a three-lunged type of arch should preferably be used in the case of bowstring bridges, since the extension in the ties may be considerable; in any case one end of the bridge should always rest on roller bearings to ensure vertical forces on the abutments. It is clear that there are disadvantages in a form of structure in which so many members are under tensional stress throughout their entire lengths, and it is often difficult to ensure that hair cracks in the concrete will not occur. On this account very conservative stresses only should be adopted in the calculation of the tension steel reinforcement.

The lateral bracing of the ribs in the bowstring type should be carefully considered and cross beams of ample strength provided to connect the ribs; these should be carried as far as possible along the ribs from the crown of the arch as the provision of the necessary headroom will permit; in addition, diagonal bracing between the ribs at the crown is often advisable.

**Methods of Calculation.**

The sufficiency of an arch design can only be checked finally by means of exact methods applied formally either graphically or algebraically. The process involves a very considerable expenditure of time and pre-supposes a knowledge of the arch thicknesses, the arch line, and the reinforcement.

In order to avoid the tedious repetition of this method, it is essential that the sections and the arch line should be determined so that a final check may give the required stresses in the section with the predetermined arch line or, at the worst, moments which can be resisted by a slight alteration in the reinforcement percentages or in the concrete mixture. The relative moments of inertia of the sections are so little affected by a slight alteration in the reinforcement that such an alteration, if required, will not invalidate the results of the check calculations as regards moments.

The main difficulty of arch design is the correct predetermination of the sections, reinforcements, and arch line. The following approximate methods can be applied in the various cases. In all cases the live loading will be considered as equivalent to a distributed load plus a single moving concentration.

**Three-hinged Arch with Earth Filling (Fig 132).**

- Let  $p$  = the distributed live loading in lb. per square foot,
- $P$  = the concentrated live load on one axle per foot width of arch (lb.),
- $r$  = the rise from centre to centre of the arch (ft.),
- $l$  = the span of arch between hinge centres (ft.),
- $w$  = the density of the filling (lb. per cubic foot), and
- $w_1$  = the density of the concrete (lb. per cubic foot).

It is a considerable convenience in the details of the calculations to place the hinges so that the clear and centre-to-centre spans are equal; if this is not the case, the modification will be obvious.

From the diagram (Fig. 132) the rate of loading at the crown for distributed loading over the full span is  $g_0 = w(h_0 - d_0) + w_1d_0 + p$  . . . . . (1) where  $d_0$  is assumed in the first instance.

Similarly  $g_1 = w(h_1 - d_1 \sec \phi_1) + w_1d_1 \sec \phi_1 + p$  . . . . . (2)

where  $d_1$  is similarly assumed, and  $\sec \phi_1 = \sqrt{1 + \frac{16r'^2}{l^2}}$  approximately.

$r$  = rise at centre  
 $= r' + \frac{1}{2}d_0 - \frac{1}{2}d_1 \sec \phi_1$  . . . . . (3)

The crown thrust due to D.L. + distributed L.L. over the whole span + concentrated L.L. at crown is

$$H_0 = \frac{(5g_0 + g_1)l^2}{48r} + \frac{Pl}{4r} . . . . . (4)$$

The vertical forces at the springings are given by

$$V_1 = (2g_0 + g_1)\frac{l}{6} + \frac{1}{2}P . . . . . (5)$$

The resultant force at the springing is

$$R = H_0 \cos \phi_1 + V_1 \sin \phi_1 \quad (6)$$

Let  $c$  = allowable concrete stress in lb. per square inch, and  $\alpha_0$  and  $\alpha_1$  the steel ratios at the crown and springing. The values of the crown and springing thicknesses are, for a modular ratio of 15,

$$d_0 = \frac{H_0}{144c(1 + 14\alpha_0)} \text{ ft.} \quad (7)$$

$$d_1 = \frac{R}{144c(1 + 14\alpha_1)} \text{ ft.} \quad (8)$$

The calculations for these equations can then be repeated if necessary, with the corrected values of  $d_0$  and  $d_1$  obtained from (7) and (8).

The maximum moment at the quarter-point is approximately

$$M_2 = \frac{1}{64} \rho l^2 + \frac{Pl}{8} \left( \frac{1}{2} + \frac{y_2}{r} \right) \text{ ft. lb.} \quad (9)$$

on the assumptions that the arch line has been drawn for dead load plus one-half the distributed live load, and that the concentrated load is placed over the quarter-point to give the maximum moment.

Here

$$y_2 = \text{quarter-point ordinate} \\ = \frac{(23g_0 + g_1)r}{16(5g_0 + g_1)}$$

The corresponding thrust is given approximately by the formula

$$N_2 = H \sec \phi_2 + \frac{P}{2} \left( \frac{l}{4r} + \frac{3r}{l} \right) \sec \phi_2 \quad (10)$$

where  $H = \left( H_0 - \frac{\rho l^2}{16r} \right)$  and  $\sec \phi_2 = \sqrt{1 + \frac{4r^2}{l^2}}$ .

The required thickness ( $d_2$ ) at the quarter-point is then to be determined by using equations (9) and (10) and the method for combined bending and thrust (see Chapter VI).

The arch line is now determined as follows:

Let 
$$g_0 = w(h_0 - d_0) + w_1 d_0 + \frac{1}{2} \rho \quad (11)$$

$\frac{1}{2} \rho$  being now substituted for  $\rho$  in equation (1) and the final value of  $d_0$  used.

Also 
$$g_1 = w(h_1 - d_1 \sec \phi_1) + w_1 d_1 \sec \phi_1 + \rho,$$

where 
$$\sec \phi_1 = \sqrt{1 + \frac{16r^2}{l^2}}$$
 in the first place.

Recalculate  $g_1$  from the equation

$$g_1 = w(h_1 - d_1 \sec \phi_1) + w_1 d_1 \sec \phi_1 + \frac{1}{2} \rho \quad (11a)$$

thus obtaining a first approximation,

using the value  $\sec \phi_1 = \sqrt{1 + \tan^2 \phi_1}$

where 
$$\tan \phi_1 = \frac{(2g_0 + g_1)}{(5g_0 + g_1)} \times \frac{8r}{l}.$$

The quantities  $g_0$  and  $g_1$  are the unit rates of loading for dead load plus one-half the live load at the crown and springing.

The quarter-point ordinate is given as a first approximation by

$$y_2 = \frac{23g_0 + g_1}{16(5g_0 + g_1)} \times r; \sec \phi_2 = \sqrt{1 + \tan^2 \phi_2}, \text{ and } \tan \phi_2 = \frac{(11g_0 + g_1)}{(5g_0 + g_1)} \times \frac{r}{l}$$

Let  $g_2$  be the rate of loading at the quarter-point, then

$$g_2 = w(h_2 - r - \frac{1}{2}d_1 \sec \phi_1 + y_2 - \frac{1}{2}d_2 \sec \phi_2) + w_1 d_2 \sec \phi_2 + \frac{1}{2}p \quad (12)$$

Using these values, a second approximation gives

$$y_2 = \frac{(24g_2 - g_1 + 97g_0)}{16(16g_2 + g_1 + 13g_0)} \times r \dots \dots \dots (13)$$

$$\sec \phi_1 = \sqrt{1 + \tan^2 \phi_1}; \tan \phi_1 = \frac{8(6g_0 + 7g_1 + 32g_2)}{3(13g_0 + g_1 + 16g_2)} \times \frac{r}{l} \dots \dots (14)$$

$$\sec \phi_2 = \sqrt{1 + \tan^2 \phi_2}; \tan \phi_2 = \frac{2(57g_0 - g_1 + 34g_2)}{3(13g_0 + g_1 + 16g_2)} \times \frac{r}{l} \dots \dots (15)$$

$g_0$  is given by equation (11)

$$g_1 = w(h_1 - d_1 \sec \phi_1) + w_1 d_1 \sec \phi_1 + \frac{1}{2}p \dots \dots \dots (16)$$

$$g_2 = w(h_2 - r - \frac{1}{2}d_1 \sec \phi_1 + y_2 - \frac{1}{2}d_2 \sec \phi_2) + w_1 d_2 \sec \phi_2 + \frac{1}{2}p \quad (17)$$

in which equation (13) is to be used for  $y_2$ , and (14) and (15) for  $\phi_1$  and  $\phi_2$ .

Then the equation to the centre line is given by

$$y = \frac{r}{3(13g_0 + g_1 + 16g_2)} \times \left[ 360g_0 \left(\frac{x}{l}\right)^2 - 80(15g_0 + g_1 + 16g_2) \left(\frac{x}{l}\right)^4 + 512(3g_0 + g_1 + 4g_2) \left(\frac{x}{l}\right)^6 \right] \quad (18)$$

$g_0$ ,  $g_1$ , and  $g_2$  being obtained from equations (11), (16), and (17).

This equation for the centre line applies to all types of arch with or without hinges, and when  $g_0$ ,  $g_1$ , and  $g_2$  have been determined correctly it gives a centre line practically coincident with the line of the resultant thrust for the assumed condition of loads. In the foregoing treatment the line is coincident with the thrust line for dead load + one-half the distributed live loads; if the terms  $\frac{1}{2}p$  are omitted the arch line agrees with the line of thrust under dead loads only.

If the semi-span is divided into ten equal divisions, equation (18) can be written

$$y = \frac{r}{30(13g_0 + g_1 + 16g_2)} \left[ 9g_0 N^2 - \frac{(15g_0 + g_1 + 16g_2)N^4}{200} + \frac{(3g_0 + g_1 + 4g_2)N^6}{12,500} \right] \quad (18a)$$

where  $N = 0, 1, 2, \dots, 10$ .

If the semi-span is divided into twenty equal divisions, equation (18) can be written

$$y = \frac{r}{120(13g_0 + g_1 + 16g_2)} \left[ 9g_0N^2 - \frac{(15g_0 + g_1 - 16g_2)N^4}{800} + \frac{(3g_0 + g_1 - 4g_2)N^6}{200,000} \right] \quad (18b)$$

where  $N = 0, 1, 2, \dots, 20$ .

**Setting out the Arch.**

From equation (18a) or (18b) the arch line is drawn as follows :

Set off  $01', 1'2', \text{ etc.}$  (Fig. 133), equal to  $01, 12, \text{ etc.}$ , on a straight line  $OP$  and set up ordinates  $\frac{1}{2}d_0, \frac{1}{2}d_2$  and  $\frac{1}{2}d_1$ , to the same scale. Describe circular arcs  $AB$  and  $AC$  tangential to a horizontal through  $A$  and draw the other ordinates. With points  $0, 1, 2, 3, \dots$  as centres describe circles with radii equal to the ordinates at  $0, 1', 2', \dots$ . Then the envelopes to the complete series of circles give the intrados and extrados of the required arch.

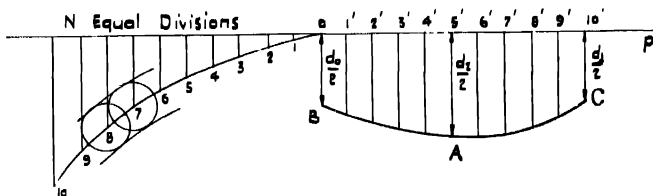

Fig. 133.

**Alternative Method for Line of Arch.**

The following method is applicable to all forms of arch and gives the arch form extremely accurately ; it is especially applicable to large spans.

Calculate  $d_0, d_1$  and  $d_2$  as already described for the three-hinged type, or, as subsequently explained, for a fixed-end arch ; then determine  $g_0$  and  $g_1$  from equations (11) and (11a). Set out the arch line by means of the equation

$$y = \frac{8r}{(5g_0 + g_1)} \left[ 3g_0 + 2(g_1 - g_0) \frac{x^2}{l^2} \right] \frac{x^2}{l^2} \dots \dots (19)$$

and draw the intrados and extrados as before.

From a scale drawing of the arch, roadway, etc., draw the line of thrust in the usual manner. A new arch is then drawn with this line of thrust as axis. The process can be repeated as a check, but this will scarcely ever be necessary, since the arch line and the line of thrust converge very rapidly.

**Unsymmetrical Three-hinged Arches.**

Wherever possible the line joining the springings should be made parallel to the line of roadway, and even when the roadway is on a slope this method of setting out the arch line can be followed, the ordinates being now set out from an inclined line through the crown hinge parallel to the roadway.

When the heights of filling over the springings on the two sides of the arch differ considerably and the arch is horizontal, the arch line can be set out as follows.

Determine  $g_0$  the crown loading,  $g_1$  the lesser loading over a springing, and  $g_1'$  the greater loading over the other springing (Fig. 134) from equations similar to (11) and (11a).

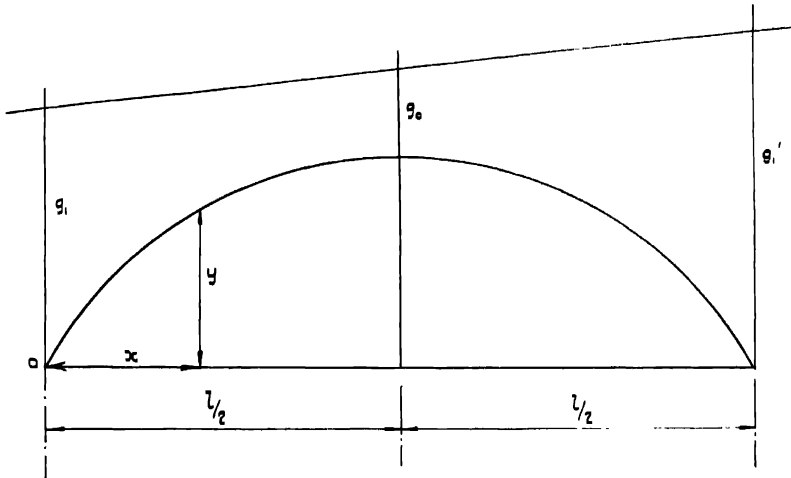

Fig. 134.

Calculate the arch thicknesses from equations (4), (5), (6), (7), (9), and (10) using the value  $\frac{1}{2}(g_1 + g_1')$  in place of  $g_1$ ,  $H$  being written

$$H = \frac{[5g_0 + \frac{1}{2}(g_1 + g_1')]l^2}{48r} + \frac{Pl}{4r}$$

Set out the arch line from the equation

$$y = \frac{8 \left[ (2g_0 + g_1) \left( \frac{x}{l} \right) - 3g_1 \left( \frac{x}{l} \right)^2 - (4g_0 - 3g_1 - g_1') \left( \frac{x}{l} \right)^3 - (g_1 + g_1' - 2g_0) \left( \frac{x}{l} \right)^4 \right] r}{(5g_0 + \frac{1}{2}g_1 + \frac{1}{2}g_1')} \quad (20)$$

For small spans this approximation to the arch line will be sufficient ; for larger spans of 100 ft. or over a closer approximation can be obtained as follows.

Set out the arch by means of equation (20) and make a scale drawing with the arch thicknesses and roadway shown. The line of thrust is then drawn graphically and a new arch is constructed with this line as axis. This process can be repeated, but the second approximation is usually sufficiently accurate.

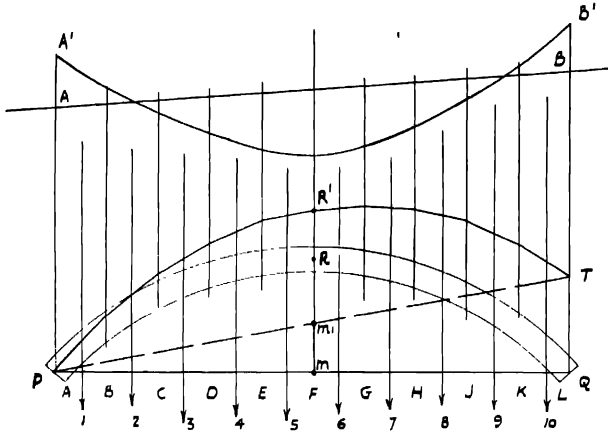

Fig. 135.

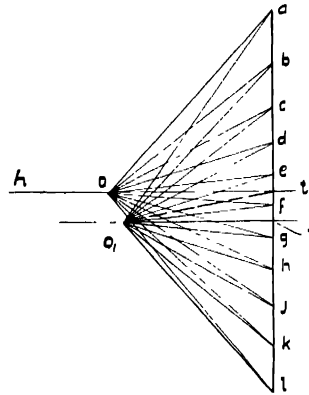

Fig. 136.

The arch line can be most conveniently drawn in all such cases as follows (Fig. 135):

- (1) Divide the span into a number of equal divisions, say 10, 20, or 40,
- (2) Draw the equivalent line of total loading  $A'B'$  with  $PQ$  as base, the weight of the arch and one-half the live loading being reduced to the equivalent depth of earth,
- (3) Calculate the weights of the equivalent filling 1, 2, 3, etc., acting at the mid-points of the equal divisions,
- (4) Set off these loads to any scale on a vertical line  $ab, bc \dots kl$ , choose any pole  $o_1$ , and join  $o_1$  to  $a, b, c \dots l$  (Fig. 136),
- (5) Starting from the springing  $P$  draw the line of thrust  $PR'T$  with sides parallel to  $o_1a, o_1b$ , etc.,



- (6) Join  $PT$  and draw  $o_1t$  parallel to  $PT$ ; through  $t$  draw a horizontal line  $ht$  and take a point  $o$  such that  $to = t'o_1 \times \frac{R'm'}{Rm}$ , where  $t'o_1$  is the perpendicular from  $o_1$  to  $al$ , and finally
- (7) Draw a line of thrust with  $o$  as pole. This line will pass through  $P$ ,  $R$ , and  $Q$ , and is the required line of thrust.

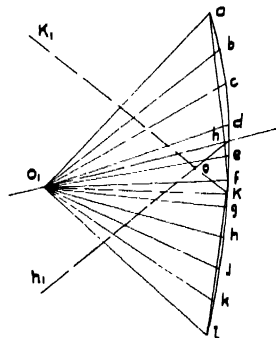
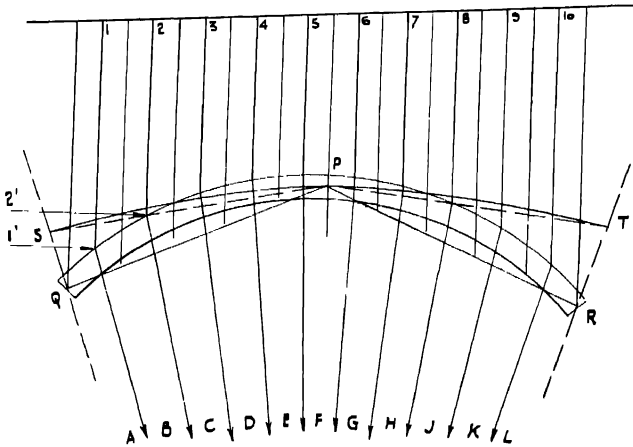

Fig. 137.

A similar method can be used where the lateral earth pressures must be taken into account as, for example, in arches of high rise-span ratio. In such cases, a line of arch being chosen according to ordinary practice, the line is corrected by drawing the corresponding line of thrust for the applied loads. If the arch line is reasonably chosen in the first instance the arch axis rapidly converges to the line of thrust, and two repetitions of the process are usually sufficient. In this case the

line of thrust is drawn as follows (*Fig. 137*). (1) Calculate the vertical loads 1, 2, 3, etc., with the corresponding minimum lateral pressure :  $\mathbf{1}' = \frac{\mathbf{1} - \sin \phi}{\mathbf{1} + \sin \phi} w h_1 \Delta h$ , etc.

(2) Draw the force polygon  $a, b, c \dots k, l$ , with any pole  $o_1$ . (3) Starting from  $P$  draw a line of thrust  $PS$ , the elements being parallel to  $o_1f, o_1e \dots o_1a$ , and the point  $s$  lying on a line through  $Q$  parallel to  $af$ . (4) Draw  $o_1h$  parallel to  $PS$ , cutting the straight line  $af$  in  $h$ , and through  $h$  draw a line  $hh_1$  parallel to  $PQ$ . (5) Starting again from  $P$ , draw a line of thrust  $PT$ ,  $T$  lying on a line  $TR$  through  $R$  parallel to  $lf$ . (6) Draw  $o_1k$  parallel to  $PT$ , cutting the straight line  $lf$  in  $k$ , and through  $k$  a line  $kk'$  parallel to  $PR$ . The intersection  $o$  of  $hh_1$  and  $kk'$  is the required pole  $o$  and a line of thrust starting from  $P$  will pass through  $Q$  and  $R$ .

The lateral thrust may vary within wide limits and many old structures are stable as the pressures vary within the limits so as to give stability. Since this may involve appreciable moments, the minimum value for the lateral pressure should be allowed.

**Three-hinged Arch with Open Superstructure.**

In this case  $g_0, g_1$ , and  $g_2$ , the load per linear foot, including full distributed live load applied to a 1-ft. width of barrel arch or to a single arch rib, are to be calculated from preliminary sketch drawings. Equations (4), (5), (6), (7), (8), (9), and (10) apply with the values to determine the arch sections.

For the arch line equations (18), (18a) and (18b) apply, and, as before,  $g_0, g_1$  and  $g_2$  are to include one-half the distributed live load only.

In estimating the dead loads due to the columns or cross walls, let  $C$  be the

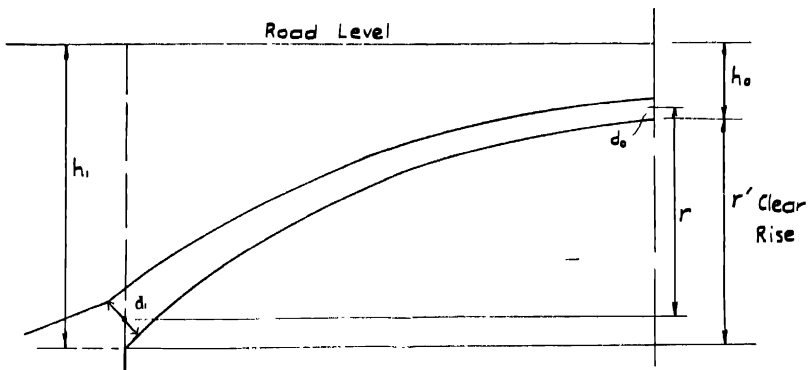

**Fig. 138.**

weight of a column placed over the springing, and  $a$  the common distance between columns. Then a value  $C/a$  is to be added to  $g_1$  and a similar quantity  $C'/a$  to  $g_2$ ,  $C'$  being the weight of a real or imaginary column over the quarter point.

The alternative graphical method previously indicated gives the most accurate results for the arch line, in this case the loads being treated as concentrations under the columns and cross walls, and the weight of the arch treated as concentrations at the same points. The arch line should then be taken as a mean line between curves inscribing and circumscribing the funicular polygon.

**Arch with Earth Filling and Built-in Ends.**

The arch rib should be arranged so that for dead load plus one-half the distributed live load the resulting moments are zero, although the curve is sometimes laid out for dead load only. The method applies equally to open superstructures ; in such cases  $g_0$  and  $g_1$  are to be estimated from sketch drawings. The rates of loading due to dead load plus one-half the live load at the crown and springings are given by

$$g_0 = w(h_0 - d_0) + w_1 d_0 + \frac{1}{2} p$$

$$g_1 = w(h_1 - d_1 \sec \phi_1) + w_1 d_1 \sec \phi_1 + \frac{1}{2} p.$$

Here  $d_1 = d_0 \left( \frac{\sec \phi_1}{n} \right)^3$  where  $n$  is a constant having any value between 0.15 and 1, but usually 0.25 to 0.30.

$$\sec \phi_1 = \sqrt{1 + \frac{16r'^2}{l^2}}$$
 as a first approximation.

With these values of  $d_0$  and  $d_1$ , calculate  $r$  and  $\sec \phi_1$  from the equations

$$r = r' + \frac{1}{2} d_0 - \frac{1}{2} d_1 \sec \phi_1$$

$$\sec \phi_1 = \sqrt{1 + \tan^2 \phi_1}$$

and

$$\tan \phi_1 = \frac{(2g_0 + g_1)}{(5g_0 + g_1)} \times \frac{8r}{l}.$$

Then second approximations are

$$g_0 = w(h_0 - d_0) + w_1 d_0 + \frac{1}{2} p \quad \dots \dots \dots (21)$$

$$g_1 = w(h_1 - d_1 \sec \phi_1) + w_1 d_1 \sec \phi_1 + \frac{1}{2} p \quad \dots \dots \dots (22)$$

$$n = \left( \frac{d_0}{d_1} \right)^3 \sec \phi_1 \quad \dots \dots \dots (23)$$

$$m = \frac{g_1}{g_0} \quad \dots \dots \dots (24)$$

The process can be repeated if necessary until there is no variation in the value of  $g_0$ ,  $g_1$ , or  $n$ .

**Crown Section.**

The thrust due to dead load plus one-half the live load is

$$H_0 = \frac{(5g_0 + g_1)l^2}{48r} \quad \dots \dots \dots (25)$$

Only the maximum positive live load moment requires to be considered, and this is given by

$$M_1 = (C_0 p l^2 + C_0' P l) \frac{1}{100} \quad \dots \dots \dots (26)$$

with a thrust

$$H_1 = \left( D_0 \frac{p l^2}{r} + D_0' \frac{P l}{r} \right) \frac{1}{10} \quad \dots \dots \dots (27)$$

where  $C_0$ ,  $C_0'$ ,  $D_0$ , and  $D_0'$  are given in order in each vertical group of the double-entry Table XIX. The coefficient  $D_0$  allows for the different distribution of live loading from that included in equation (25).

In this method, the concentration is assumed to be placed over the crown of the arch.

TABLE XIX.  
Values of  $C_0, C_0', D_0,$  and  $D_0'$ — $C_{10n}$  Section

| m    | Values of m |       |       |       |       |       |       |       |       |       |       |       |       |       |       |       |       |       |
|------|-------------|-------|-------|-------|-------|-------|-------|-------|-------|-------|-------|-------|-------|-------|-------|-------|-------|-------|
|      | 1.0         | 1.5   | 2.0   | 2.5   | 3.0   | 3.5   | 4.0   | 4.5   | 5.0   | 5.5   | 6.0   | 6.5   | 7.0   | 7.5   | 8.0   | 8.5   |       |       |
| 1.0  | $C_0$       | 0.54  | 0.55  | 0.56  | 0.57  | 0.58  | 0.58  | 0.59  | 0.59  | 0.60  | 0.61  | 0.61  | 0.61  | 0.62  | 0.62  | 0.63  | 0.64  |       |
|      | $C_0'$      | 4.7   | 4.9   | 5.0   | 5.2   | 5.3   | 5.4   | 5.6   | 5.7   | 5.8   | 5.8   | 5.9   | 5.9   | 6.0   | 6.0   | 6.0   | 6.0   |       |
|      | $D_0$       | -0.03 | -0.01 | +0.02 | +0.04 | +0.06 | +0.08 | +0.10 | -0.11 | -0.11 | -0.13 | +0.14 | +0.15 | +0.16 | +0.17 | +0.18 | +0.18 | 0.19  |
| 0.8  | $C_0$       | 2.34  | 2.35  | 2.35  | 2.37  | 2.37  | 2.38  | 2.40  | 2.40  | 2.41  | 2.41  | 2.41  | 2.42  | 2.42  | 2.43  | 2.43  | 2.43  | 0.61  |
|      | $C_0'$      | 0.52  | 0.53  | 0.54  | 0.54  | 0.55  | 0.56  | 0.57  | 0.57  | 0.58  | 0.58  | 0.59  | 0.59  | 0.59  | 0.60  | 0.61  | 0.61  | 0.61  |
|      | $D_0$       | 4.6   | 4.8   | 4.9   | 5.0   | 5.1   | 5.2   | 5.3   | 5.4   | 5.5   | 5.6   | 5.7   | 5.7   | 5.8   | 5.8   | 5.9   | 5.9   | 5.9   |
| 0.6  | $C_0$       | -0.04 | 0.00  | +0.02 | +0.04 | +0.06 | +0.07 | +0.08 | +0.10 | -0.11 | +0.13 | +0.13 | +0.14 | +0.15 | +0.16 | +0.17 | +0.18 | +0.19 |
|      | $C_0'$      | 2.41  | 2.43  | 2.45  | 2.46  | 2.47  | 2.49  | 2.50  | 2.51  | 2.52  | 2.53  | 2.53  | 2.53  | 2.54  | 2.54  | 2.54  | 2.54  | 2.54  |
|      | $D_0$       | 0.49  | 0.50  | 0.50  | 0.51  | 0.52  | 0.52  | 0.53  | 0.53  | 0.54  | 0.54  | 0.55  | 0.55  | 0.56  | 0.57  | 0.57  | 0.58  | 0.58  |
| 0.5  | $C_0$       | 4.4   | 4.6   | 4.7   | 4.9   | 5.0   | 5.1   | 5.2   | 5.3   | 5.3   | 5.3   | 5.3   | 5.4   | 5.4   | 5.4   | 5.5   | 5.6   | 5.6   |
|      | $C_0'$      | -0.04 | 0.00  | +0.02 | +0.04 | +0.06 | +0.07 | +0.08 | +0.10 | -0.11 | +0.13 | +0.13 | +0.14 | +0.15 | +0.16 | +0.17 | +0.18 | +0.19 |
|      | $D_0$       | 2.41  | 2.43  | 2.45  | 2.46  | 2.47  | 2.49  | 2.50  | 2.51  | 2.52  | 2.53  | 2.53  | 2.53  | 2.54  | 2.54  | 2.54  | 2.54  | 2.54  |
| 0.4  | $C_0$       | 0.47  | 0.48  | 0.49  | 0.49  | 0.50  | 0.50  | 0.51  | 0.51  | 0.52  | 0.52  | 0.53  | 0.53  | 0.54  | 0.54  | 0.54  | 0.55  | 0.55  |
|      | $C_0'$      | 4.3   | 4.5   | 4.6   | 4.8   | 4.9   | 4.9   | 5.0   | 5.1   | 5.2   | 5.3   | 5.3   | 5.4   | 5.4   | 5.4   | 5.5   | 5.5   | 5.5   |
|      | $D_0$       | -0.04 | -0.01 | +0.02 | +0.04 | +0.06 | +0.07 | +0.08 | +0.10 | -0.11 | +0.13 | +0.13 | +0.14 | +0.15 | +0.16 | +0.17 | +0.18 | +0.19 |
| 0.3  | $C_0$       | 0.46  | 0.47  | 0.47  | 0.47  | 0.48  | 0.48  | 0.49  | 0.49  | 0.50  | 0.50  | 0.51  | 0.51  | 0.52  | 0.52  | 0.52  | 0.53  | 0.53  |
|      | $C_0'$      | 4.2   | 4.4   | 4.5   | 4.7   | 4.8   | 4.8   | 4.9   | 5.0   | 5.1   | 5.2   | 5.2   | 5.2   | 5.2   | 5.3   | 5.3   | 5.4   | 5.4   |
|      | $D_0$       | -0.04 | -0.01 | +0.01 | +0.04 | +0.05 | +0.07 | +0.08 | +0.10 | -0.11 | +0.13 | +0.13 | +0.14 | +0.15 | +0.16 | +0.17 | +0.18 | +0.19 |
| 0.25 | $C_0$       | 2.47  | 2.49  | 2.51  | 2.53  | 2.54  | 2.57  | 2.57  | 2.58  | 2.59  | 2.60  | 2.61  | 2.62  | 2.62  | 2.63  | 2.63  | 2.64  | 2.64  |
|      | $C_0'$      | 0.44  | 0.44  | 0.45  | 0.46  | 0.46  | 0.47  | 0.48  | 0.48  | 0.48  | 0.48  | 0.49  | 0.49  | 0.49  | 0.50  | 0.50  | 0.51  | 0.51  |
|      | $D_0$       | -0.04 | -0.01 | +0.01 | +0.04 | +0.05 | +0.06 | +0.08 | +0.09 | -0.10 | +0.10 | +0.11 | +0.12 | +0.14 | +0.15 | +0.17 | +0.17 | +0.17 |
| 0.20 | $C_0$       | 0.43  | 0.43  | 0.44  | 0.44  | 0.45  | 0.45  | 0.46  | 0.46  | 0.46  | 0.47  | 0.47  | 0.47  | 0.47  | 0.47  | 0.48  | 0.48  | 0.48  |
|      | $C_0'$      | 4.1   | 4.2   | 4.3   | 4.4   | 4.5   | 4.6   | 4.7   | 4.8   | 4.9   | 4.9   | 4.9   | 5.0   | 5.1   | 5.1   | 5.2   | 5.2   | 5.2   |
|      | $D_0$       | -0.04 | -0.02 | -0.01 | +0.03 | +0.05 | +0.06 | +0.08 | +0.09 | -0.10 | +0.10 | +0.11 | +0.13 | +0.14 | +0.15 | +0.16 | +0.17 | +0.17 |
| 0.15 | $C_0$       | 2.54  | 2.57  | 2.59  | 2.62  | 2.64  | 2.66  | 2.67  | 2.68  | 2.69  | 2.70  | 2.71  | 2.72  | 2.73  | 2.74  | 2.74  | 2.75  | 2.75  |
|      | $C_0'$      | 0.41  | 0.42  | 0.42  | 0.43  | 0.43  | 0.43  | 0.44  | 0.44  | 0.45  | 0.45  | 0.45  | 0.45  | 0.46  | 0.46  | 0.46  | 0.46  | 0.46  |
|      | $D_0$       | 4.0   | 4.1   | 4.3   | 4.4   | 4.5   | 4.5   | 4.6   | 4.7   | 4.7   | 4.8   | 4.8   | 4.9   | 4.9   | 4.9   | 5.0   | 5.0   | 5.0   |
| 0.1  | $C_0$       | -0.04 | -0.01 | +0.01 | +0.03 | +0.05 | +0.06 | +0.08 | +0.09 | -0.10 | +0.10 | +0.11 | +0.13 | +0.13 | +0.15 | +0.16 | +0.17 | +0.17 |
|      | $C_0'$      | 2.58  | 2.61  | 2.63  | 2.66  | 2.68  | 2.70  | 2.71  | 2.73  | 2.74  | 2.75  | 2.77  | 2.77  | 2.79  | 2.80  | 2.81  | 2.81  | 2.81  |
|      | $D_0$       | 0.40  | 0.40  | 0.41  | 0.42  | 0.42  | 0.43  | 0.43  | 0.44  | 0.44  | 0.44  | 0.44  | 0.44  | 0.45  | 0.45  | 0.45  | 0.45  | 0.45  |
| 0.05 | $C_0$       | 3.9   | 4.0   | 4.2   | 4.3   | 4.4   | 4.4   | 4.5   | 4.5   | 4.6   | 4.7   | 4.7   | 4.8   | 4.8   | 4.8   | 4.9   | 4.9   | 4.9   |
|      | $C_0'$      | -0.01 | +0.02 | +0.03 | +0.04 | +0.05 | +0.06 | +0.08 | +0.09 | -0.10 | +0.10 | +0.11 | +0.12 | +0.13 | +0.15 | +0.16 | +0.17 | +0.17 |
|      | $D_0$       | 2.65  | 2.65  | 2.68  | 2.71  | 2.73  | 2.76  | 2.77  | 2.79  | 2.80  | 2.81  | 2.83  | 2.83  | 2.84  | 2.85  | 2.87  | 2.88  | 2.88  |

TABLE XX  
Values of  $E_0$

| $\mu$ | Values of $m$ |      |      |      |      |      |      |      |      |      |      |      |      |      |      |      |
|-------|---------------|------|------|------|------|------|------|------|------|------|------|------|------|------|------|------|
|       | 1.0           | 1.5  | 2.0  | 2.5  | 3.0  | 3.5  | 4.0  | 4.5  | 5.0  | 5.5  | 6.0  | 6.5  | 7.0  | 7.5  | 8.0  | 8.5  |
| 1.0   | 1620          | 1650 | 1690 | 1720 | 1740 | 1750 | 1770 | 1790 | 1800 | 1820 | 1830 | 1850 | 1870 | 1880 | 1890 | 1900 |
| 0.8   | 1860          | 1900 | 1950 | 1980 | 2010 | 2040 | 2060 | 2080 | 2100 | 2120 | 2130 | 2140 | 2160 | 2180 | 2180 | 2190 |
| 0.6   | 2210          | 2260 | 2310 | 2360 | 2400 | 2420 | 2480 | 2510 | 2540 | 2550 | 2570 | 2590 | 2610 | 2620 | 2640 | 2650 |
| 0.5   | 2450          | 2520 | 2580 | 2630 | 2680 | 2730 | 2760 | 2800 | 2830 | 2850 | 2860 | 2900 | 2930 | 2950 | 2970 | 3000 |
| 0.4   | 2780          | 2860 | 2940 | 3000 | 3050 | 3110 | 3150 | 3200 | 3220 | 3230 | 3250 | 3310 | 3350 | 3380 | 3400 | 3440 |
| 0.3   | 3220          | 3320 | 3420 | 3500 | 3580 | 3650 | 3700 | 3760 | 3820 | 3870 | 3900 | 3950 | 3980 | 4010 | 4040 | 4070 |
| 0.25  | 3510          | 3630 | 3740 | 3810 | 3930 | 4010 | 4080 | 4140 | 4200 | 4260 | 4310 | 4370 | 4410 | 4450 | 4480 | 4520 |
| 0.2   | 3910          | 4040 | 4160 | 4270 | 4370 | 4460 | 4540 | 4620 | 4680 | 4750 | 4820 | 4880 | 4930 | 4970 | 5010 | 5080 |
| 0.15  | 4370          | 4550 | 4710 | 4840 | 4970 | 5080 | 5180 | 5270 | 5350 | 5420 | 5500 | 5570 | 5640 | 5720 | 5780 | 5840 |

Values of  $E_0'$

| $\mu$ | Values of $m$ |       |       |       |       |       |       |       |       |       |       |       |       |       |       |       |
|-------|---------------|-------|-------|-------|-------|-------|-------|-------|-------|-------|-------|-------|-------|-------|-------|-------|
|       | 1.0           | 1.5   | 2.0   | 2.5   | 3.0   | 3.5   | 4.0   | 4.5   | 5.0   | 5.5   | 6.0   | 6.5   | 7.0   | 7.5   | 8.0   | 8.5   |
| 1.0   | 0.333         | 0.323 | 0.315 | 0.309 | 0.303 | 0.297 | 0.292 | 0.288 | 0.284 | 0.281 | 0.277 | 0.274 | 0.272 | 0.270 | 0.267 | 0.264 |
| 0.8   | 0.345         | 0.303 | 0.297 | 0.292 | 0.286 | 0.280 | 0.275 | 0.272 | 0.268 | 0.264 | 0.261 | 0.258 | 0.255 | 0.253 | 0.250 | 0.246 |
| 0.6   | 0.292         | 0.282 | 0.274 | 0.269 | 0.264 | 0.258 | 0.254 | 0.250 | 0.246 | 0.243 | 0.240 | 0.237 | 0.235 | 0.232 | 0.229 | 0.226 |
| 0.5   | 0.278         | 0.269 | 0.261 | 0.256 | 0.250 | 0.245 | 0.241 | 0.237 | 0.234 | 0.230 | 0.227 | 0.224 | 0.222 | 0.220 | 0.217 | 0.214 |
| 0.4   | 0.262         | 0.253 | 0.246 | 0.241 | 0.236 | 0.230 | 0.226 | 0.222 | 0.218 | 0.216 | 0.213 | 0.210 | 0.208 | 0.206 | 0.203 | 0.200 |
| 0.3   | 0.244         | 0.235 | 0.228 | 0.223 | 0.218 | 0.212 | 0.208 | 0.205 | 0.202 | 0.199 | 0.197 | 0.193 | 0.191 | 0.189 | 0.187 | 0.184 |
| 0.25  | 0.233         | 0.225 | 0.218 | 0.213 | 0.208 | 0.203 | 0.198 | 0.196 | 0.192 | 0.189 | 0.186 | 0.184 | 0.182 | 0.180 | 0.178 | 0.175 |
| 0.2   | 0.222         | 0.214 | 0.207 | 0.202 | 0.197 | 0.191 | 0.188 | 0.186 | 0.182 | 0.179 | 0.176 | 0.174 | 0.172 | 0.170 | 0.168 | 0.165 |
| 0.15  | 0.210         | 0.202 | 0.197 | 0.192 | 0.187 | 0.181 | 0.178 | 0.175 | 0.172 | 0.168 | 0.166 | 0.164 | 0.162 | 0.159 | 0.157 | 0.154 |

The thrust (negative) due to temperature fall of  $t_0$  deg. F. is approximately given by

$$H_t = E_0 \frac{t_0 b d_0^3}{r^2} (1 + 0.269p) \tag{28}$$

$p$  being the total steel percentage at the crown. The coefficient  $E_0$  is contained in *Table XX*,  $b$  being the breadth of arch rib and all dimensions measured in feet. The value of the modulus of elasticity is assumed in calculating  $E_0$  as  $E = 288,000,000$  (lb. ft.) and the coefficient of expansion  $w = 6 \times 10^{-6}$ .

The positive moment (ft. lb.) is

$$M_t = -E_0' H_t r \tag{29}$$

The thrust (negative) due to shortening of the arch axis is approximately given by

$$H_s = - \left( \frac{0.3}{n} + \frac{1}{\sec \phi_1} \right) \frac{d_0^2}{r^2} \times H_0 \tag{30}$$

and

$$M_s = E_0' H_s r \tag{31}$$

where  $E_0'$  is obtained from *Table XX*.

The crown thrust is

$$H = H_0 + H_t + H_l + H_s \tag{32}$$

using equations (25), (27), (28), and (30).

The positive crown moment is

$$M = M + M + M_s \tag{33}$$

using equations (26), (29), and (31).

The crown section is then designed for combined moment and thrust. Should there be a considerable difference from the assumed value of  $d_0$ , the calculation must be repeated using equations 21, 22, 23, and 24, keeping  $n$  at its chosen value, and modifying  $d_1$  and  $m$  to suit.

### Springing Section.

Using the final values of  $g_0$  and  $g_1$

$$H_0 = \frac{(5g_0 + g_1)l^2}{48r}, \tan \phi_1 = \frac{(2g_0 + g_1)}{(5g_0 + g_1)} \times \frac{8r}{l}$$

and the normal thrust is

$$N_1 = H_0 \sec \phi_1 \tag{34}$$

The negative moment due to the live load is given by

$$M_l = - (C_1 p l^2 + C_1' P l) \frac{1}{100} \tag{35}$$

and the corresponding live-load thrust by

$$N_l = \left( D_1 \frac{p l^2}{r} + D_1' \frac{P l}{r} \right) \frac{\sec \phi'}{10} \tag{36}$$

The values of  $C_1$ ,  $C_1'$ ,  $D_1$  and  $D_1'$  are given by *Table XXI*. The value of  $m$  being  $\frac{g_1}{g_0}$ , as before, and  $n = \left( \frac{d_0}{d_1} \right)^3 \sec \phi_1$ .

TABLE XXI.  
Values of  $C_1$ ,  $C_1'$ ,  $D_1$ , and  $D_1'$ —Springing Section

| n   | Values of m |        |        |        |        |        |        |        |        |        |        |        |        |        |        |        |
|-----|-------------|--------|--------|--------|--------|--------|--------|--------|--------|--------|--------|--------|--------|--------|--------|--------|
|     | 1.0         | 1.5    | 2.0    | 2.5    | 3.0    | 3.5    | 4.0    | 4.5    | 5.0    | 5.5    | 6.0    | 6.5    | 7.0    | 7.5    | 8.0    | 8.5    |
| .0  | $C_1$       | 1.71   | 1.76   | 1.79   | 1.81   | 1.83   | 1.84   | 1.87   | 1.90   | 1.92   | 1.94   | 1.95   | 1.96   | 1.97   | 1.99   | 2.00   |
|     | $C_1'$      | 6.75   | 6.60   | 6.40   | 6.30   | 6.20   | 6.14   | 6.11   | 6.08   | 6.06   | 6.04   | 6.03   | 6.02   | 6.01   | 5.99   | 5.97   |
|     | $D_1$       | -0.23  | -0.24  | -0.25  | -0.25  | -0.26  | -0.26  | -0.27  | -0.27  | -0.28  | -0.28  | -0.28  | -0.28  | -0.28  | -0.28  | -0.28  |
| .2  | $C_1$       | 1.77   | 1.81   | 1.85   | 1.86   | 1.89   | 1.90   | 1.94   | 1.96   | 1.97   | 1.99   | 2.01   | 2.03   | 2.04   | 2.07   | 2.08   |
|     | $C_1'$      | 6.98   | 6.80   | 6.70   | 6.55   | 6.40   | 6.35   | 6.30   | 6.20   | 6.15   | 6.10   | 6.00   | 6.00   | 6.00   | 5.95   | 5.90   |
|     | $D_1$       | -0.24  | -0.25  | -0.26  | -0.28  | -0.29  | -0.30  | -0.31  | -0.32  | -0.32  | -0.33  | -0.34  | -0.35  | -0.35  | -0.35  | -0.35  |
| .4  | $C_1$       | 1.86   | 1.90   | 1.94   | 1.97   | 2.01   | 2.02   | 2.04   | 2.06   | 2.08   | 2.10   | 2.12   | 2.13   | 2.14   | 2.15   | 2.17   |
|     | $C_1'$      | 7.32   | 7.15   | 7.06   | 6.95   | 6.75   | 6.66   | 6.60   | 6.50   | 6.40   | 6.35   | 6.30   | 6.25   | 6.20   | 6.15   | 6.10   |
|     | $D_1$       | -0.683 | -0.699 | -0.710 | -0.720 | -0.730 | -0.740 | -0.749 | -0.756 | -0.766 | -0.770 | -0.772 | -0.777 | -0.782 | -0.787 | -0.791 |
| .5  | $C_1$       | 1.92   | 1.98   | 2.01   | 2.04   | 2.07   | 2.09   | 2.12   | 2.14   | 2.15   | 2.17   | 2.19   | 2.21   | 2.22   | 2.24   | 2.25   |
|     | $C_1'$      | 7.54   | 7.35   | 7.20   | 7.10   | 7.00   | 6.87   | 6.80   | 6.70   | 6.60   | 6.50   | 6.40   | 6.30   | 6.20   | 6.10   | 6.05   |
|     | $D_1$       | -0.24  | -0.25  | -0.26  | -0.28  | -0.29  | -0.30  | -0.31  | -0.32  | -0.33  | -0.34  | -0.34  | -0.35  | -0.36  | -0.36  | -0.36  |
| .6  | $C_1$       | 2.00   | 2.05   | 2.10   | 2.11   | 2.14   | 2.17   | 2.19   | 2.22   | 2.25   | 2.27   | 2.28   | 2.29   | 2.30   | 2.32   | 2.34   |
|     | $C_1'$      | 7.84   | 7.65   | 7.50   | 7.40   | 7.20   | 7.15   | 7.10   | 7.00   | 6.90   | 6.80   | 6.80   | 6.70   | 6.60   | 6.50   | 6.45   |
|     | $D_1$       | -0.24  | -0.25  | -0.26  | -0.28  | -0.29  | -0.30  | -0.32  | -0.33  | -0.34  | -0.35  | -0.35  | -0.36  | -0.36  | -0.37  | -0.37  |
| .8  | $C_1$       | 2.11   | 2.15   | 2.20   | 2.23   | 2.26   | 2.30   | 2.32   | 2.34   | 2.36   | 2.38   | 2.41   | 2.43   | 2.44   | 2.46   | 2.48   |
|     | $C_1'$      | 8.23   | 8.10   | 7.91   | 7.78   | 7.60   | 7.53   | 7.40   | 7.30   | 7.25   | 7.25   | 7.10   | 7.10   | 7.00   | 6.85   | 6.80   |
|     | $D_1$       | -0.24  | -0.25  | -0.26  | -0.28  | -0.29  | -0.30  | -0.31  | -0.32  | -0.33  | -0.34  | -0.35  | -0.36  | -0.37  | -0.37  | -0.37  |
| .9  | $C_1$       | 2.17   | 2.23   | 2.28   | 2.30   | 2.33   | 2.37   | 2.40   | 2.42   | 2.44   | 2.47   | 2.48   | 2.50   | 2.52   | 2.54   | 2.56   |
|     | $C_1'$      | 8.48   | 8.30   | 8.10   | 8.00   | 7.90   | 7.77   | 7.70   | 7.60   | 7.50   | 7.40   | 7.35   | 7.30   | 7.15   | 7.10   | 7.08   |
|     | $D_1$       | -0.25  | -0.26  | -0.27  | -0.29  | -0.30  | -0.31  | -0.32  | -0.34  | -0.34  | -0.35  | -0.36  | -0.37  | -0.37  | -0.38  | -0.38  |
| 1.0 | $C_1$       | 2.26   | 2.31   | 2.37   | 2.39   | 2.43   | 2.46   | 2.49   | 2.53   | 2.54   | 2.57   | 2.59   | 2.61   | 2.63   | 2.65   | 2.67   |
|     | $C_1'$      | 8.62   | 8.48   | 8.30   | 8.20   | 8.10   | 8.06   | 8.00   | 7.90   | 7.80   | 7.70   | 7.65   | 7.60   | 7.40   | 7.35   | 7.30   |
|     | $D_1$       | -0.26  | -0.27  | -0.28  | -0.30  | -0.31  | -0.32  | -0.34  | -0.34  | -0.35  | -0.36  | -0.36  | -0.37  | -0.37  | -0.38  | -0.39  |
| 1.2 | $C_1$       | 2.36   | 2.42   | 2.46   | 2.50   | 2.54   | 2.57   | 2.61   | 2.64   | 2.66   | 2.69   | 2.72   | 2.74   | 2.75   | 2.77   | 2.81   |
|     | $C_1'$      | 8.95   | 8.80   | 8.65   | 8.50   | 8.42   | 8.30   | 8.25   | 8.10   | 8.00   | 7.90   | 7.80   | 7.75   | 7.60   | 7.55   | 7.50   |
|     | $D_1$       | -0.27  | -0.28  | -0.30  | -0.31  | -0.32  | -0.33  | -0.34  | -0.35  | -0.36  | -0.37  | -0.37  | -0.38  | -0.39  | -0.39  | -0.39  |
| 1.5 | $C_1$       | 2.46   | 2.53   | 2.58   | 2.62   | 2.66   | 2.70   | 2.74   | 2.78   | 2.81   | 2.84   | 2.87   | 2.90   | 2.92   | 2.95   | 2.99   |
|     | $C_1'$      | 9.30   | 9.15   | 9.00   | 8.85   | 8.70   | 8.55   | 8.45   | 8.30   | 8.20   | 8.10   | 8.00   | 7.90   | 7.80   | 7.70   | 7.70   |
|     | $D_1$       | -0.28  | -0.29  | -0.31  | -0.32  | -0.33  | -0.34  | -0.35  | -0.36  | -0.37  | -0.37  | -0.38  | -0.39  | -0.39  | -0.40  | -0.40  |

TABLE XXII.  
Values of  $F_1$ —Springing Section.

| H    | Values of m |       |       |       |       |       |       |       |       |       |       |       |       |       |       |       |
|------|-------------|-------|-------|-------|-------|-------|-------|-------|-------|-------|-------|-------|-------|-------|-------|-------|
|      | 1.0         | 1.5   | 2.0   | 2.5   | 3.0   | 3.5   | 4.0   | 4.5   | 5.0   | 5.5   | 6.0   | 6.5   | 7.0   | 7.5   | 8.0   | 8.5   |
| 1.0  | 0.667       | 0.677 | 0.685 | 0.691 | 0.697 | 0.703 | 0.708 | 0.712 | 0.716 | 0.719 | 0.723 | 0.726 | 0.728 | 0.730 | 0.733 | 0.736 |
| 0.8  | 0.685       | 0.695 | 0.703 | 0.708 | 0.714 | 0.720 | 0.724 | 0.728 | 0.732 | 0.736 | 0.739 | 0.742 | 0.745 | 0.747 | 0.750 | 0.754 |
| 0.6  | 0.708       | 0.718 | 0.726 | 0.731 | 0.736 | 0.742 | 0.746 | 0.750 | 0.754 | 0.757 | 0.760 | 0.763 | 0.765 | 0.768 | 0.771 | 0.774 |
| 0.5  | 0.722       | 0.731 | 0.739 | 0.744 | 0.750 | 0.755 | 0.759 | 0.763 | 0.766 | 0.770 | 0.773 | 0.776 | 0.778 | 0.780 | 0.783 | 0.786 |
| 0.4  | 0.738       | 0.747 | 0.754 | 0.759 | 0.764 | 0.770 | 0.774 | 0.778 | 0.782 | 0.784 | 0.787 | 0.790 | 0.792 | 0.794 | 0.797 | 0.800 |
| 0.3  | 0.756       | 0.765 | 0.772 | 0.777 | 0.782 | 0.788 | 0.792 | 0.795 | 0.798 | 0.801 | 0.803 | 0.807 | 0.809 | 0.811 | 0.813 | 0.816 |
| 0.25 | 0.767       | 0.775 | 0.782 | 0.787 | 0.792 | 0.797 | 0.801 | 0.804 | 0.808 | 0.811 | 0.814 | 0.816 | 0.818 | 0.820 | 0.823 | 0.825 |
| 0.20 | 0.778       | 0.786 | 0.793 | 0.798 | 0.803 | 0.808 | 0.812 | 0.814 | 0.818 | 0.821 | 0.824 | 0.826 | 0.828 | 0.830 | 0.832 | 0.835 |
| 0.15 | 0.790       | 0.798 | 0.803 | 0.808 | 0.813 | 0.819 | 0.822 | 0.825 | 0.828 | 0.831 | 0.834 | 0.836 | 0.838 | 0.841 | 0.843 | 0.846 |

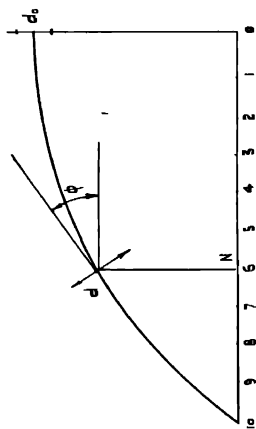

Fig. 139

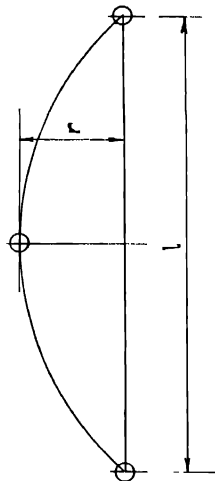

Fig. 140.



The thrust (negative) due to a temperature fall is

$$N_t = H_t \sec \phi_1 \quad \dots \quad (37)$$

where  $H_t$  is obtained from equation (28).

The negative moment is

$$M_t = F_1 H_t r \quad \dots \quad (38)$$

The thrust due to arch shortening is

$$N_s = H_s \sec \phi_1 \quad \dots \quad (39)$$

and the negative moment is

$$M_s = F_1 H_s r \quad \dots \quad (40)$$

The values of  $F_1$  are given in *Table XXII*.

The total thrust at the springing is

$$N = N_1 + N_t \mid N_t + N_s \quad \dots \quad (41)$$

and the total negative moment

$$M = M_1 + M_t + M_s \quad \dots \quad (42)$$

The section is then to be designed for this thrust and moment, and the process is to be repeated, if necessary, until there is no variation in the required values of  $d_0$  and  $d_1$ .

**Variation of Arch Thickness.**

Let  $N$  be the number of the point of division of the semi-span (*Fig. 139*) assumed divided into ten or twenty parts. Then  $d$ , the corresponding thickness of the arch, is usually assumed to have the following values :

$$d = \frac{d_0}{\left\{ \left[ 1 - (1 - n) \frac{N}{10} \right] \cos \phi \right\}^i}; N = 1, 2, 3, \dots 10 \quad \dots \quad (43)$$

$$d = \frac{d_0}{\left\{ \left[ 1 - (1 - n) \frac{N}{20} \right] \cos \phi \right\}^i}; N = 1, 2, 3, \dots 20 \quad \dots \quad (43a)$$

where  $\cos \phi = \frac{1}{\sqrt{1 + \tan^2 \phi}} \quad \dots \quad (44)$

and  $\tan \phi = \frac{1}{(m + 5)} \left\{ 2.4N + \frac{(m - 1)N^3}{125} \right\} \frac{r}{l}, N = 1, 2, 3, \dots 10 \quad \dots \quad (45)$

$$\tan \phi = \frac{1}{(m + 5)} \left\{ 1.2N + \frac{(m - 1)N^3}{1000} \right\} \frac{r}{l}, N = 1, 2, 3, \dots 20 \quad \dots \quad (45a)$$

From the calculated values the arch is to be set out in a manner similar to that explained in the case of the three-hinged arch, and using equation (18a) or (18b).

**Bowstring Girders.**

The best type of bowstring girder appears to be the three-hinged (*Fig. 140*), although two-hinged arches are most commonly used. The calculation for the former is very simple and identical with that described under "Three-hinged Arch with Open Superstructure".

The tension in the deck ties is given by the equation

$$H = \frac{(5g_0 + g_1)l^2}{48r} + \frac{Pl}{4r},$$

where the full live load is included when calculating  $g_0$  and  $g_1$ . The most satisfactory arrangement of decking appears to consist of stiff transverse main beams supporting longitudinals of the minimum practicable depth. The ties can be kept entirely separate from the decking (*Fig. 141*), and should be made of the minimum

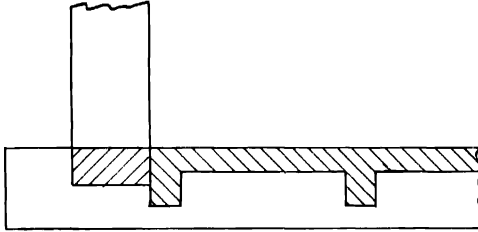

Fig. 141.

depth which will allow concrete to be placed properly round the reinforcing bars. In construction, a length in the middle of the span should be left un-concreted until after the centering has been struck. In this way, the large deflection at the centre, due to the dropping of the crown of the arches, will have little effect on the ties, since these ties will remain approximately straight over each half span with an angular intersection at the centre. Under actual working conditions the effect

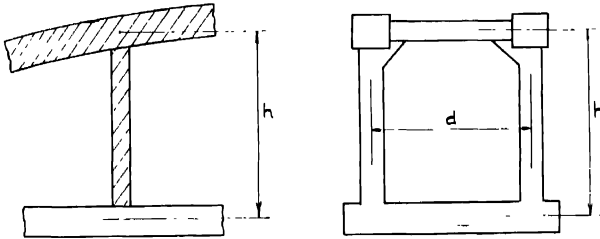

Fig. 142.

of live load will not be great, provided the deflections due to dead load have been dealt with in this way. Horizontal bending in the decking due to lateral wind loading can be dealt with by placing some additional steel in the outer longitudinal deck beams. In these conditions it is sufficient to calculate the ties for tension due to  $H$  and to their own weight, the latter causing bending between the hangers. The tension in the ties should be restricted to 12,000 lb. per square inch.

Should cantilever footpaths be provided, these should be constructed so as to avoid bringing a load on the ties, and in all cases deep members should be avoided for the ties or the deck longitudinals. Parapet walls, if occurring over the ties, should be supported independently, and should be provided with joints at intervals to allow deflection.

The vertical hangers should be regarded as cantilevers or portal frames built into the transverse deck beams, and should be designed for the lateral wind loads on the lengths of the arch ribs between the hangers and on the hangers themselves, in addition to the direct tension. They should be as narrow in the planes of the arches as will allow satisfactory concreting and placing of the reinforcement. The steel stress should be restricted between 12,000 lb. and 14,000 lb. per square inch.

The vertical hangers towards the ends of the spans cannot usually be connected transversely between the arch ribs to form frames, on account of considerations of headroom; these hangers should be designed as cantilevers built into the transverse deck beams and loaded by the wind pressure on the corresponding length of arch rib and on the hangers themselves. It is usual to calculate for direct

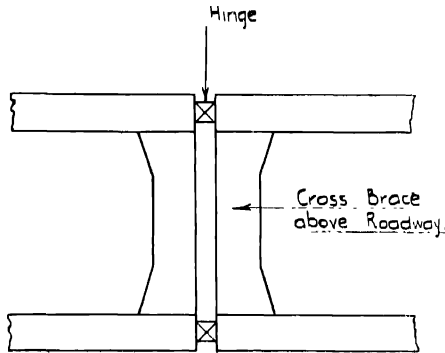

Fig. 143.—Plan at Crown.

tension and bending on the steel, neglecting the concrete. Hangers towards the centre of the spans should be calculated as built-in frames in the following manner. Let  $P$  = the total wind pressure on the hatched area on the diagram (Fig. 142), applying to one hanger,  $h$  = the height from centre of the transverse deck beam to the centre line of the horizontal top member,  $I_1$  = the moment of inertia of the hanger,  $I_2$  = the moment of inertia of the top member, and  $K = \frac{I_2 h}{I_1 d}$  where  $d$  = the distance between the arch ribs (Fig. 142). Then the hangers should be designed for a moment  $M = \frac{1}{2}Ph \frac{(1 + 3K)}{(1 + 6K)}$  in addition to the direct load, and the top member calculated to resist a moment

$$M = \frac{1}{2}Ph \frac{3K}{(6K + 1)}$$

The horizontal transverse members should be carried as far out from the crown as considerations of headroom will permit. Cross beams should also be inserted to connect the arch ribs (Fig. 143) at the crown; these should be of equal strength in horizontal bending to that of the ribs themselves.

## EXAMPLES OF ARCH DESIGN.

The application of the foregoing formulæ, tables, and design procedures will now be explained by means of two examples: (i) a three-hinged arch with solid earth filling, and (ii) an arch rib with built-in ends. In both cases the permissible stresses in the concrete and steel and the modular ratio are illustrative only, and the methods described will apply whatever maximum stresses and modular ratio are specified.

**Example of Three-hinged Arch with Solid Earth Filling.**

In this case (*Fig. 144*) the preliminary data are: the clear span = 70 ft. 6 in.,  $r^1 =$  clear rise = 8 ft. 10 in. Road level at crown of arch = 32.14 O.D. Level of soffit of arch = 29.56 O.D. Ministry of Transport loading. Assumed maximum stresses: Concrete 700 lb. per square inch; steel 16,000 lb. per square inch. Fall of roadway from crown, 1 in 45. Use equations (1) to (18).

Centre to centre span and rise—

$$\sec \phi_1 = \sqrt{1 + \frac{16 \times (8.83)^2}{70.5^2}} = 1.12 \text{ approximately.}$$

Assuming a crown thickness  $d_0 = 11$  in., and a springing thickness  $d_1 = 12$  in., then  $r = 8$  ft. 10 in. +  $\frac{11}{2}$  in. -  $(\frac{1}{2} \times 12 \text{ in.} \times 1.12) = 8.73$  ft. .

$$l = 70 \text{ ft. 6 in.} + \left( 12 \text{ in.} \times \sqrt{\frac{(1.12)^2 - 1}{(1.12)^2}} \right) = 71 \text{ ft.}$$

Rate of loading at crown for dead load plus one-half live load—

|                |                              |   |     |
|----------------|------------------------------|---|-----|
| Weight of arch | $12 \times 11$               | = | 132 |
| Filling        | $(32.14 - 29.56 - 0.92) 100$ | = | 166 |
| Half live load | $= \frac{1}{2} \times 220$   | = | 110 |

$$g_0 = 408 \text{ lb. per square foot.}$$

Rate of loading at springings—

|                |  |   |     |
|----------------|--|---|-----|
| Weight of arch | $= 12 \times 12 \times 1.12$   | = | 161 |
| Filling        | $= \left[ 8.73 + 0.46 + 1.66 - \left( \frac{1}{2} \times 1 \times 1.12 \right) - \frac{71}{2 \times 45} \right] 100$ | = | 950 |
| Half live load |  | = | 110 |

$$g_1 \text{ (first approximation) in lb. per square foot} = 1220$$

The corrected value of  $\phi_1$  is given by

$$\tan \phi_1 = \frac{2g_0 + g_1}{5g_0 + g_1} \times \frac{8r}{l} = \frac{2 \times 408 + 1220}{5 \times 408 + 1220} \times \frac{8 \times 8.73}{71} = 0.615$$

and  $\sec \phi_1 = \sqrt{1 + (0.615)^2} = 1.174.$

The corrected rise  $r = 8$  ft. 10 in. +  $\frac{11}{2}$  in. -  $(\frac{1}{2} \times 12 \times 1.174) = 8.70$  ft.

The corrected span  $l = 70$  ft. 6 in. +  $\left( 12 \times \sqrt{\frac{(1.174)^2 - 1}{(1.174)^2}} \right) = 71$  ft.

FIG. 144.

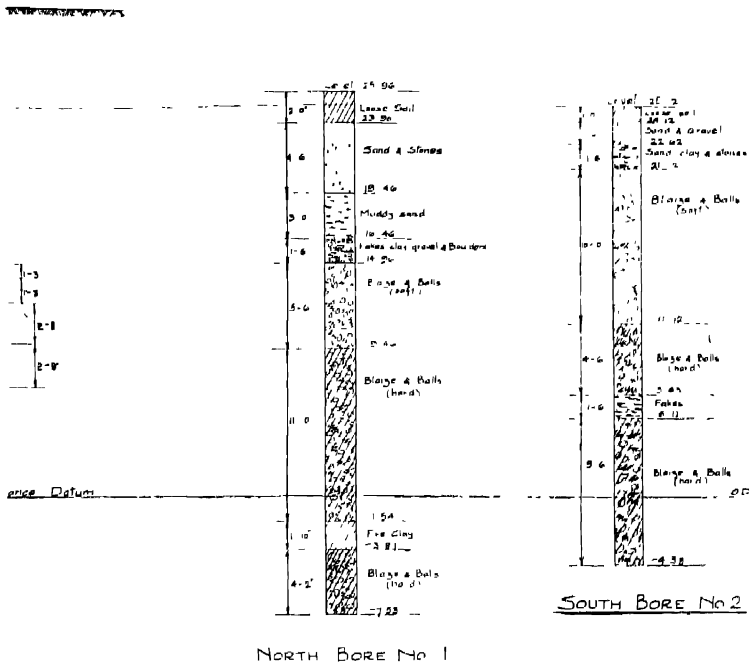

CORPORATION OF PAISLEY  
HAWKHEAD ROAD BRIDGE.  
LONGITUDINAL SECTIONS.

ENGINEER: MR. JAMES LEE, A.M.INST.C.E



The corrected rate of loading is

$$\text{Weight of arch} = 12 \times 12 \times 1.174 \qquad \qquad \qquad = 169$$

$$\text{Filling} \left( 8.70 + 0.46 + 1.66 - \frac{1}{2} \times 1 \times 1.174 - \frac{71}{2 \times 45} \right) 100 = 945$$

$$\text{Half live load} \qquad \qquad \qquad \qquad \qquad \qquad \qquad \qquad \qquad = 110$$

---

$$g_1 \text{ (in lb. per square foot)} = 1224$$

The quarter-point ordinate

$$y_2 = \frac{23g_0 + g_1}{16(5g_0 + g_1)} \times r = \frac{23 \times 408 + 1224}{16(5 \times 408 + 1224)} \times 8.70 = 1.75 \text{ ft.}$$

The inclination at the quarter point is given by

$$\tan \phi_2 = \frac{11g_0 + g_1}{5g_0 + g_1} \times \frac{r}{l} = \frac{11 \times 408 + 1224}{5 \times 408 + 1224} \times \frac{8.70}{71} = 0.213$$

$$\sec \phi_2 = \sqrt{1 + \tan^2 \phi_2} = 1.024.$$

CROWN SECTION (11 IN. THICK).—Calculating for full live loading,

$$g_0 = 408 + 110 = 518 \text{ lb. per square foot.}$$

$$g_1 = 1224 + 110 = 1334 \text{ lb. per square foot.}$$

$$H_0 = \frac{(5g_0 + g_1)l^2}{48r} = \frac{71^2 \times 3924}{48 \times 8.70} = 47,500 \text{ lb. due to dead loading.}$$

$$\frac{Pl}{4r} = \frac{71 \times 2700}{4 \times 8.70} = 5,520 \text{ lb. due to live loading.}$$

$$H_0 = 53,020 \text{ lb.}$$

Placing  $\frac{7}{8}$ -in. diameter bars at 12-in. centres on both faces (1 per cent. of steel), the equivalent area =  $(12 \times 11) + (2 \times 0.6 \times 14) = 149$ , and the concrete stress at the crown is  $\frac{53,020}{149} = 355$  lb. per square inch.

The hinge bars will consist of groups of three bars  $\frac{7}{8}$  in. diameter every  $6\frac{1}{2}$  in. with a compressive stress of

$$53,020 \times \frac{2.167}{0.6 \times 12} = 16,000 \text{ lb. per square inch,}$$

and the length of the hinge bars is  $2 \times 45 \times \frac{7}{8}$  in., say, 7 ft.

ABUTMENT SECTION (12 IN. THICK).—

$$\tan \phi_1 = 0.615; \phi_1 = 31 \text{ deg. } 36 \text{ min.}; \cos \phi_1 = 0.8517; \sin \phi_1 = 0.5240.$$

$$V_1 = (2g_0 + g_1)\frac{l}{6} + \frac{1}{2}P = 28,000 + 1350 = 29,350 \text{ lb.}$$

$$R = H_0 \cos \phi_1 + V_1 \sin \phi_1 = 53,020 \times 0.8517 + 29,350 \times 0.5240 = 60,500 \text{ lb.}$$

Placing  $\frac{7}{8}$ -in. diameter bars at 12-in. centres on both faces, the equivalent area is  $(12 \times 12) + (2 \times 0.6 \times 14) = 161$  sq. in., and the concrete stress is  $\frac{60,500}{161} = 375$  lb. per square inch.

At the hinge, placing three 1-in. bars in every 7 in., the steel stress

$$= \frac{60,500 \times 2.33}{0.785 \times 12} = 15,000 \text{ lb. per square inch,}$$

and the length of the bars is  $90 \times 1 \text{ in.} = 7 \text{ ft. } 6 \text{ in.}$

QUARTER-POINT SECTIONS.—

$$M_2 = \frac{pl^2}{64} + \frac{Pl}{8} \left( \frac{1}{2} + \frac{y_2}{r} \right); \quad ($$

$$N_2 = H \sec \phi_2 + \frac{P}{2} \left( \frac{l}{4r} + \frac{3r}{l} \right) \text{ where } \sec \phi_2 = 1.024;$$

$$\frac{pl^2}{64} = \frac{71^2 \times 220 \times 12}{64} = 208,000 \text{ in. lb.};$$

$$\frac{Pl}{8} \left( \frac{1}{2} + \frac{y_2}{r} \right) = 12 \times \frac{2700 \times 71}{8} \left( 0.5 + \frac{1.75}{8.70} \right) = 202,000 \text{ in. lb.};$$

$$M = 410,000 \text{ in. lb.}$$

$$H = 47,500 - \frac{pl^2}{16r} = 47,500 - \frac{71^2 \times 220}{16 \times 8.70} = 39,500 \text{ lb.}$$

$$\text{and } \frac{P}{2} \left( \frac{l}{4r} + \frac{3r}{l} \right) = 1350 \left( \frac{71}{4 \times 8.70} + \frac{3 \times 8.70}{71} \right) = 3250 \text{ lb.}$$

$$\text{Then } N_2 = 39,500 \times 1.024 + \frac{3250}{1.024} = 43,600 \text{ lb.}$$

The total moment  $M = 410,000 \text{ in. lb.}$ , and the total thrust  $N = 43,600 \text{ lb.}$

$$\therefore \frac{N}{Mbc} = \frac{(43,600)^2}{410,000 \times 12 \times 700} = 0.55.$$

Placing 1 per cent. of steel ( $\frac{1}{2}$  per cent. on each face), with  $k$  assumed = 0.075,

the curves [Case IV (A), Fig. 124] give  $\left( \frac{N}{bdc} \right)^2 = 0.075$  and  $\frac{N}{bdc} = 0.2740$ .

$$\text{Then } d = \frac{N}{bc \times 0.2740} = \frac{43,600}{12 \times 700 \times 0.2740} = 19 \text{ in.}$$

A thickness of 20 in. was assumed and the value of  $k \left( \frac{1.5}{20} - 0.075 \right)$  is as assumed.

Using curves [Case IV (C), Fig. 126],  $\frac{Nd}{M} = \frac{43,600 \times 20}{410,000} = 2.13$ , giving for

$$p = 1 \text{ per cent. } \frac{N}{bdc} = 0.291.$$

The concrete stress is  $\frac{43,600}{12 \times 20 \times 0.291} = 625 \text{ lb. per square inch,}$  and the



FIG. 145.  
 [SEE OVERLEAF  
 FOR FIG. 146]

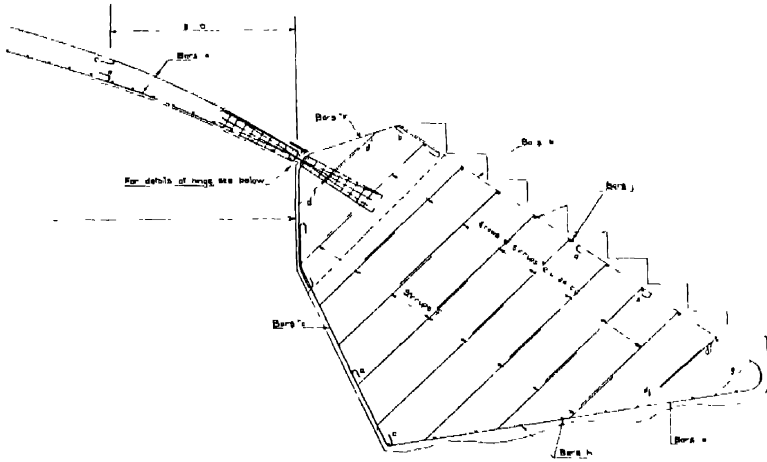

CORPORATION OF PAISLEY.

HAWKHEAD ROAD BRIDGE.

NOTES - FOR DIMENSIONS IN CONNECTION WITH ARCH SPANS  
 AND ABUTMENTS SEE FIG. 146 NO SCALE A.  
 IT IS IMPORTANT THAT THE EARTH SAVING OVER THE ARCH MUST  
 BE BROUGHT TO EQUALLY GOOD BOTH SIDES.

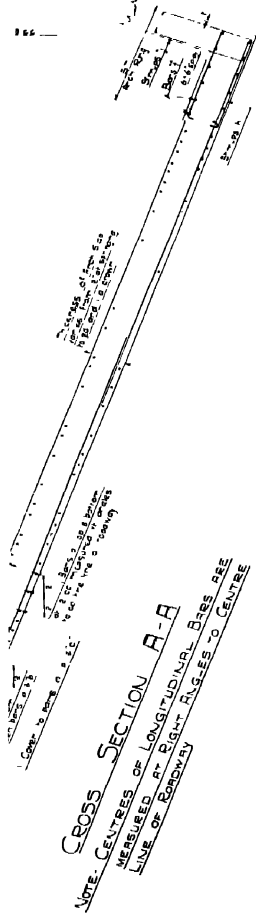

SCHEDULE OF REINFORCING STEEL

| POSITION               | No. Bars | REINFORCEMENT |       |         | REMARKS   |
|------------------------|----------|---------------|-------|---------|---|
|                        |          | Size          | Shape | Remarks |   |
| ABUTMENT 2             | a        | 30            | 3/8"  | 33 8    | In bottom of 20 cc  |
|                        | b        | 30            | 3/8"  | 14 8    | On outside of 20 cc Splicing with bars a  |
|                        | c        | 30            | 3/8"  | 13 8    | On inside of 20 cc Splicing with bars a   |
|                        | d        | 60            | 1/2"  | 8 8     | Stirrups in pairs round pairs of bars a & b at minimum  |
|                        | e        | 120           | 1/2"  | 8 8     | Stirrups at 20cc over pairs of bars a & b   |
|                        | f        | 12            | 1/2"  | 8 8     |   |
|                        | g        | 12            | 1/2"  | 8 8     |   |
|                        | h        | 12            | 1/2"  | 8 8     |   |
|                        | i        | 12            | 1/2"  | 8 8     |   |
|                        | j        | 12            | 1/2"  | 8 8     |   |
|                        | k        | 12            | 1/2"  | 8 8     |   |
|                        | l        | 12            | 1/2"  | 8 8     |   |
|                        | m        | 12            | 1/2"  | 8 8     |   |
|                        | n        | 12            | 1/2"  | 8 8     |   |
| ABUTMENT HINGE 2       | o        | 30            | 1/2"  | 8 8     | Stirrups round pairs of bars a on top of abutment   |
|                        | p        | 30            | 1/2"  | 8 8     | In bottom of 20 cc on bars a & b at 20cc  |
|                        | q        | 30            | 1/2"  | 8 8     | Under bars a & b at 20cc & 2 min splices  |
|                        | r        | 24            | 1/2"  | 8 8     | At top of abutment splicing with bars b & c at 20cc   |
|                        | s        | 6             | 1/2"  | 8 8     | At top of abutment do do  |
|                        | t        | 6             | 1/2"  | 8 8     |   |
|                        | u        | 6             | 1/2"  | 8 8     |   |
|                        | v        | 6             | 1/2"  | 8 8     |   |
|                        | w        | 6             | 1/2"  | 8 8     |   |
|                        | x        | 6             | 1/2"  | 8 8     |   |
| ARCH SLABS ARCH RING 2 | y        | 120           | 1/2"  | 8 8     | Spiral binding round groups of bars a at 4 ft pitch Each group to be assembled before placing in position |
|                        | z        | 120           | 1/2"  | 8 8     | At 12 cc each side of hinge   |
|                        | aa       | 240           | 1/2"  | 8 8     | Binders at 3 cc round pairs of bars b   |
|                        | ab       | 12            | 1/2"  | 8 8     | Longitudinal bars at 12 cc both faces of Arch Slab  |
|                        | ac       | 12            | 1/2"  | 8 8     | Do Do   |
|                        | ad       | 12            | 1/2"  | 8 8     | Lapping with bars b   |
|                        | ae       | 12            | 1/2"  | 8 8     | Longitudinal bars at 12 cc both faces of arch between pairs of binders                                    |
|                        | af       | 12            | 1/2"  | 8 8     | Transverse bars at bottom of 12 cc on bars a  |
|                        | ag       | 12            | 1/2"  | 8 8     | Transverse bars in bottom of 12 cc on bars b  |
|                        | ah       | 12            | 1/2"  | 8 8     | Longitudinal bars at 12 cc bottom of arch rings under horizontal walls                                    |
| CROWN HINGE 1          | ai       | 12            | 1/2"  | 8 8     | Do Do   |
|                        | aj       | 12            | 1/2"  | 8 8     | Lapping with bars b   |
|                        | ak       | 12            | 1/2"  | 8 8     | Stirrups round bars b & c at 20cc   |
|                        | al       | 12            | 1/2"  | 8 8     | Vertical stirrups in spandrel walls of 20cc   |
|                        | am       | 12            | 1/2"  | 8 8     |   |
|                        | an       | 12            | 1/2"  | 8 8     |   |
|                        | ao       | 12            | 1/2"  | 8 8     |   |
|                        | ap       | 12            | 1/2"  | 8 8     |   |
|                        | aq       | 12            | 1/2"  | 8 8     |   |
|                        | ar       | 12            | 1/2"  | 8 8     |   |
| ARCH RING 2            | as       | 120           | 1/2"  | 8 8     | These bars to have middle of each end straight  |
|                        | at       | 120           | 1/2"  | 8 8     | In groups of three Groups at 12 cc as shown   |
|                        | au       | 120           | 1/2"  | 8 8     | Spiral binding round groups of bars a at 4 ft pitch Each group to be assembled before placing in position |
|                        | av       | 120           | 1/2"  | 8 8     | At 12 cc each side of hinge   |
|                        | aw       | 120           | 1/2"  | 8 8     | Binders at 3 cc round pairs of bars b   |
|                        | ax       | 120           | 1/2"  | 8 8     | Longitudinal bars at 12 cc both faces of arch between pairs of binders                                    |
|                        | ay       | 120           | 1/2"  | 8 8     | Transverse bars at bottom of 12 cc on bars a  |
|                        | az       | 120           | 1/2"  | 8 8     | Transverse bars in bottom of 12 cc on bars b  |
|                        | ba       | 120           | 1/2"  | 8 8     | Longitudinal bars at 12 cc bottom of arch rings under horizontal walls                                    |
|                        | bb       | 120           | 1/2"  | 8 8     | Do Do   |
| ARCH RING 2            | bc       | 120           | 1/2"  | 8 8     | These bars to have middle of each end straight  |
|                        | bd       | 120           | 1/2"  | 8 8     | In groups of three Groups at 12 cc as shown   |
|                        | be       | 120           | 1/2"  | 8 8     | Spiral binding round groups of bars a at 4 ft pitch Each group to be assembled before placing in position |
|                        | bf       | 120           | 1/2"  | 8 8     | At 12 cc each side of hinge   |
|                        | bg       | 120           | 1/2"  | 8 8     | Binders at 3 cc round pairs of bars b   |
|                        | bh       | 120           | 1/2"  | 8 8     | Longitudinal bars at 12 cc both faces of arch between pairs of binders                                    |
|                        | bi       | 120           | 1/2"  | 8 8     | Transverse bars at bottom of 12 cc on bars a  |
|                        | bj       | 120           | 1/2"  | 8 8     | Transverse bars in bottom of 12 cc on bars b  |
|                        | bk       | 120           | 1/2"  | 8 8     | Longitudinal bars at 12 cc bottom of arch rings under horizontal walls                                    |
|                        | bl       | 120           | 1/2"  | 8 8     | Do Do   |

CORPORATION OF PAISLEY  
HAWKHEAD ROAD BRIDGE

PLAN & CROSS SECTION GIVING DETAILS  
OF ABUTMENT, HINGES & ARCH

F A MACDONALD & PARTNERS  
135 WELLINGTON STREET GLASGOW

WKG DRAWING No - 367-4

DRAWN BY *AW* CHECKED BY *AW*

TRACED BY *AW* 04 20 30 APPROVED BY

DRAWING MUST BE USED IN CONJUNCTION

DRAWING NOS. 367-5 AND 367-6

steel stress is  $625 \times 10 = 6250$  lb. per square inch. Seven-eighth-inch bars are placed at 6-in. centres on both faces, giving  $p = \frac{4 \times 0.6 \times 100}{12 \times 20} = 1$  per cent.

LINE OF ARCH.—For dead load plus half live loading

$$g_0 = 408, g_1 = 1224, \sec \phi_1 = 1.174, \text{ and } \sec \phi_2 = 1.024.$$

At the quarter point the loading is, with  $y_2 = 1.75$ ,

$$\text{Weight of arch } 12 \times 20 \times 1.024 \qquad 246$$

$$\text{Filling } \left( 0.46 + 1.66 + 1.75 - 0.83 \times 1.024 \times \frac{71}{4 \times 45} \right) 100 = 286$$

$$\text{Half live load} \qquad 110$$

$$g_2 = 642$$

Then

$$\frac{30(13g_0 + g_1 + 16g_2)}{(15g_0 + g_1 + 16g_2)r} + \frac{1}{15.776}$$

$$\frac{6000(13g_0 + g_1 + 16g_2)}{(3g_0 + g_1 + 4g_2)r} = \frac{1}{3957}$$

$$\frac{375,000(13g_0 + g_1 + 16g_2)}{5,839,800}$$

The equation to the centre line is then

$$y = \left( \frac{N^2}{15.776} + \frac{N^4}{3957} - \frac{N^6}{5,839,800} \right),$$

where  $N$  is assumed to be equal to 0, 1, 2, . . . 10.

The arch line having been set out to scale and the outline of the soffit determined corresponding to the varying thicknesses of the arch from 20 in. to 11 in., the ordinates to the soffit from a chosen base line can be scaled and a dimensioned drawing made of the soffit to enable the contractor to set out the arch.

A parabola of the sixth degree has been used for illustrative purposes and should be used for large span arches. For spans under 100 ft. it is, however, usually sufficient to set out the ordinates from the equation

$$y = \frac{N^2 r}{100(5g_0 + g_1)} \left( 6g_0 + \frac{N^2}{100}(g_1 - g_0) \right)$$

where  $N$  is assumed to be 0, 1, 2 . . . 10.

The details of the reinforcement are shown in the drawings (*Figs. 145 and 146*).

### Example of Arch Rib with Built-in Ends.

In this case (*Fig. 147*) the centre-to-centre span  $l = 188$  ft. 9 in., and the rise centre to centre is  $r = 33$  ft. 6 in. The bridge was designed for the Ministry of Transport loading, with an allowable concrete stress  $c = 900$  lb. per square inch and an allowable steel stress of 16,000 lb. per square inch. The width of

roadway carried by each arch is 19 ft., and the width of footpath 6 ft. 6 in. with a load of 85 lb. per square foot. Use equations (21) to (45*a*) and *Tables XIX to XXII*.

Rates of dead loading.—From the details of the decking the rates of loading are

9490 lb. per linear foot at the crown

11,540 lb. per linear foot at the springings, including the weight of the ribs.

Rates due to dead loading plus one-half live loading.

At the crown

$$\begin{aligned} \text{Dead load} &= 9490 \text{ lb.} \\ \text{Half live load} &= \frac{1}{2} \times 220 \times 19 = 2090 \text{ lb.} \\ \text{Pavement loading} &= \frac{1}{2} (6.5 \times 85) = 280 \text{ lb.} \end{aligned}$$

$$g_0 = 11,860 \text{ lb.}$$

At the springings

$$\begin{aligned} \text{Dead load} &= 11,540 \text{ lb.} \\ \text{Half live load} &= 2090 \text{ lb.} \\ \text{Pavement} &= 280 \text{ lb.} \end{aligned}$$

$$g_1 = 13,910 \text{ lb.}$$

$$\text{Then } m = \frac{g_1}{g_0} = \frac{13,910}{11,860} = 1.17$$

$$\tan \phi_1 = \frac{(2g_0 + g_1)}{(5g_0 + g_1)} \times \frac{8r}{l} = \frac{37,630 \times 8 \times 33.5}{73,210 \times 188.75} = 0.73$$

$$\sec \phi_1 = \sqrt{1 + \tan^2 \phi_1} = 1.24.$$

The concentration due to the knife-edge loading is  $19 \times 2700 = 51,400$  lb.;

$$n = \frac{d_0^3}{d_1^3 \cos \phi_1} \text{ will be assumed equal to } 0.32.$$

MOMENT AT THE CROWN.—

Distributed live load

$$\begin{aligned} &= \frac{1}{100} C_0 P l^2 \\ &= \frac{1}{100} \times 0.445 \times 4730 \times (188.75)^2 = 750,000 \text{ ft. lb.} \end{aligned}$$

Concentrated load at crown

$$= \frac{1}{100} C'_0 P l = \frac{1}{100} \times 4.20 \times 51,400 \times 188.75 = 406,000 \text{ ft. lb.}$$

Temperature fall of 30 deg. F.

$$= E_0 E'_0 \times \frac{t b_0 d_0^3}{\gamma} \times (1 + 0.269p)$$

$$= \frac{3160 \times 0.244 \times 30 \times 5.33 \times (4.17)^3 \times 1.378}{33.5} = 369,000 \text{ ft. lb.}$$



close in the preliminary design to the assumed value of  $n = 0.32$ . Then  $\frac{Nd}{M} = \frac{1,588,600 \times 46}{22,600,000} = 3.23$ . Using curves [Case IV (D), Fig. 127] with, say,

$p = 1.4$  per cent. it will be found that  $\frac{N}{bdc} = 0.460$ . The concrete stress is

then 
$$c = \frac{1,588,600}{0.460 \times 60 \times 46} = 1250 \text{ lb. per square inch.}$$

The "increased" stress  $c'$  may be calculated as follows:

Using  $\frac{7}{16}$ -in. interlocking helices  $1\frac{1}{2}$  in. diameter at  $2\frac{1}{2}$  in. pitch then

$$c' = c(1 + fsv) \text{ where } fs = 32 \text{ and } v = \frac{4 \times \text{area of bar}}{\text{diameter} \times \text{pitch}} = \frac{4 \times 0.15}{14.5 \times 2.5}$$

$$900 \left( 1 + \frac{32 \times 4 \times 0.15}{14.5 \times 2.5} \right) = 1380 \text{ lb. per square inch}$$

in place of 1250 lb. per square inch actual stress.

The total steel area required is  $1.4 \times 46 \times \frac{60}{100} = 38.7$  sq. in., and thirty-two  $1\frac{1}{4}$ -in. bars ( $\approx 39.3$  sq. in) are used.

SPRINGING SECTION.—As for the crown section, the following values apply:

$H_0 = 1,620,000$  lb;  $\sec \phi_1 = 1.24$ ;  $m = 1.17$ ;  $n = 0.32$ ;  $H_t = 45,000$  lb.; and  $H_s = 43,800$  lb.

The values of the constants from the tables are as follows:  $C_1 = 2.1$ ;  $D_1 = 0.24$ ;  $F_1 = 0.758$ ;  $C_1' = 8.05$ ; and  $D_1' = 0.635$ .

Moment (negative) at springing.—

Distributed live load 
$$= \frac{1}{100} C_1 p l^2 \text{ ft. lb.}$$

$$= \frac{1}{100} \times 2.1 \times 4730 \times (188.75)^2 = 3,540,000$$

Concentrated live load 
$$= \frac{1}{100} C_1' P l$$

$$= \frac{1}{100} \times 8.05 \times 51,400 \times 188.75 = 780,000$$

Temperature fall of 30 deg. F. 
$$= F_1 H_t r$$

$$= 0.758 \times 45,000 \times 33.5 = 1,140,000$$

Arch shortening 
$$= F_1 H_s r = 0.758 \times 43,800 \times 33.5 = 1,110,000$$

Total = 6,570,000

The total negative moment is then

$$M = -6,570,000 \times 12 = -79,000,000 \text{ in. lb.}$$

Thrust at springing.—

Distributed live load 
$$= \frac{1}{10} D_1 \frac{p l^2}{r} \sec \phi_1$$

$$= \frac{1}{10} \times 0.24 \times 4730 \times (188.75)^2 \times \frac{1.24}{33.5} = 150,000 \text{ lb.}$$

|                             |  |       |             |
|-----------------------------|--|-------|-------------|
| Concentrated live load      | $= \frac{1}{10} D_1 \frac{Pl}{r} \sec \phi_1$                                      |       | lb.         |
|                             | $= \frac{1}{10} \times 0.635 \times 51,400 \times 188.75 \times \frac{1.24}{33.5}$ | =     | 22,800      |
| Temperature fall 30 deg. F. | $= \frac{H_t}{\sec \phi_1} = \frac{45,000}{1.24}$                                  | =     | 36,300      |
| Arch shortening             | $= \frac{H_s}{\sec \phi_1} = \frac{43,800}{1.24}$                                  | =     | 35,300      |
| Dead loading                | $= 1,620,000 \times 1.24$  | +     | 2,010,000   |
|                             |  | Total | + 1,811,200 |

The total moment at the springing = 79,000,000 in lb

The total thrust at the springing = + 1,811,200 lb.

With  $\frac{7}{16}$ -in. helices placed at 2-in. pitch the allowable increased stress = 1380 lb. per square inch as at the crown section.

The core breadth being  $b = 60$  in. as at the crown,

$$\frac{N^2}{Mbc} = \frac{1,811,200^2}{79,000,000 \times 60 \times 1380} = 0.500$$

with  $p = 1.75$  per cent.,  $\left(\frac{N}{dbc}\right)^2 = 0.087$ , and  $\frac{N}{bdc} = 0.295$

giving  $d = \frac{1,811,200}{60 \times 0.295 \times 1380} = 74$  in.

A net area of 60 in. by 75 in. or an overall section 64 in. by 79 in. is assumed.

The reinforcement is  $1.75 \times 60 \times \frac{74}{100} = 78$  sq. in., or 39 sq. in. on each face.

The steel stress =  $10.5 \times 1380 = 14,500$  lb. per square inch

Thirty-two  $1\frac{1}{4}$ -in. bars are placed on each face, and five  $\frac{7}{16}$ -in. interlocking helices at  $2\frac{1}{2}$ -in. pitch and  $14\frac{1}{2}$  in. diameter are placed throughout (see Fig. 148).

THICKNESS OF ARCH RING.—With  $m = 1.17$ ,

$$n = \frac{46^3 \times 1.24}{75^3} = 0.286$$

and using the equations

$$\text{depth } d = \left\{ \frac{d_0}{\left[ 1 - (1-n)\frac{N}{10} \right] \cos \phi} \right\} = \left\{ \frac{d_0}{(1 - 0.0714N) \cos \phi} \right\}^{\frac{1}{2}}$$

$$\cos \phi = \sqrt{1 + \tan^2 \phi}$$

$$\tan \phi = \frac{1}{(m+5)} \left\{ 2.4N + \frac{(m-1)N^3}{125} \right\} \frac{r}{l} = \frac{1}{14.46} \left( N + \frac{N^3}{1766} \right)$$

the following values are found.

| $N$ | $\tan \phi$ | $\cos \phi$ | $\left\{ \left[ 1 - (1 - r) \frac{N}{10} \right] \cos \phi \right\}^2$ | $\frac{d}{d_0}$ | Core depth<br>$d$ (in.) | Overall depth<br>$D$ (ft. in.) |
|-----|-------------|-------------|--|-----------------|-------------------------|--------------------------------|
| 0   | 0           | 1           | 1  | 1               | 46                      | 4 2                            |
| 1   | 0.069       | 0.998       | 0.976  | 1.025           | 47.2                    | 4 3 $\frac{1}{4}$              |
| 2   | 0.138       | 0.990       | 0.946  | 1.056           | 48.6                    | 4 4 $\frac{1}{2}$              |
| 3   | 0.208       | 0.980       | 0.917  | 1.090           | 50.2                    | 4 6 $\frac{1}{2}$              |
| 4   | 0.279       | 0.963       | 0.883  | 1.131           | 52                      | 4 8                            |
| 5   | 0.351       | 0.944       | 0.847  | 1.180           | 54.4                    | 4 10 $\frac{1}{2}$             |
| 6   | 0.423       | 0.921       | 0.808  | 1.239           | 57                      | 5 1                            |
| 7   | 0.497       | 0.896       | 0.766  | 1.306           | 60.1                    | 5 4                            |
| 8   | 0.573       | 0.868       | 0.720  | 1.390           | 64                      | 5 8                            |
| 9   | 0.651       | 0.839       | 0.671  | 1.490           | 68.5                    | 6 0 $\frac{1}{2}$              |
| 10  | 0.732       | 0.807       | 0.615  | 1.627           | 75                      | 6 7                            |

AXIAL LINE OF ARCH.—It will be sufficiently accurate to employ the equation

$$y = \frac{3r}{50(m+5)} N^2 + \frac{r(m-1)}{10^4(m+5)} N^4 \text{ where } N = 0, 1, 2, \dots, 10$$

$$= \frac{N^2}{3.07} + \frac{N^4}{10,830} \text{ giving the values:}$$

| $N$ | $r$ (ft. in.)      | $N$ | $r$ (ft. in.)       |
|-----|--------------------|-----|---------------------|
| 0   | 0                  | 6   | 11 10 $\frac{1}{2}$ |
| 1   | 0 3 $\frac{7}{8}$  | 7   | 16 2 $\frac{1}{2}$  |
| 2   | 1 3 $\frac{5}{8}$  | 8   | 21 2 $\frac{1}{2}$  |
| 3   | 2 11 $\frac{1}{4}$ | 9   | 26 11 $\frac{1}{4}$ |
| 4   | 5 2 $\frac{1}{2}$  | 10  | 33 6                |
| 5   | 8 2 $\frac{1}{2}$  |     |                     |

The arch is then set out for these ordinates and thicknesses and the heights to the soffit determined by scale. *Figs. 147 and 148* show the setting out and reinforcement of the arch ring; the dimensions were determined at the twelfth-points of division to suit the centering employed.

The design having been prepared the stresses at the crown, springing and quarter-point sections can be checked by the usual methods. Actually it will seldom be necessary to modify the design if ample reinforcement is provided.



## CHAPTER VIII

### FOUNDATIONS

BEARING PRESSURES—COFFERDAMS—PILING—EXAMPLES—MASS ABUTMENTS—  
CELLULAR ABUTMENTS

THE type of bridge to be used in a given case should not be decided without a thorough knowledge of the site conditions and the nature of the subsoil. It will be realised that a hingeless or two-hinged arch requires unyielding abutments, and that a small horizontal movement or uneven settlement of the abutments may prove disastrous for such a structure. It is usually only by trial, however, that it is found that the cost of abutments may render prohibitive the use of an arch where, for clearance reasons, the springing must be high above foundation level and the rise/span ratio has to be fairly small because of road level requirements. *Fig. 149* shows such a bridge and, despite suitable bearing material near the surface, an arch bridge is clearly uneconomical due to the very large abutments required. A fixed or two-hinged portal frame would

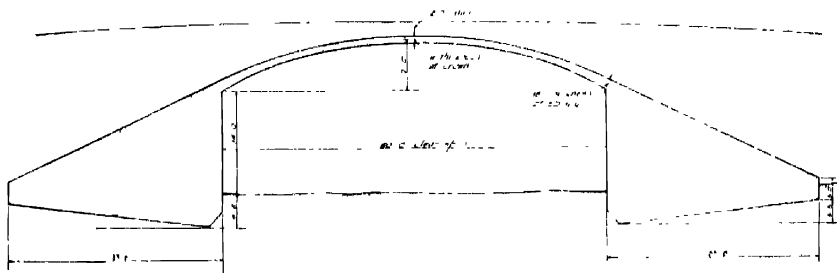

**Fig. 149.**

probably be the better solution. Consideration of the foundation problem is therefore of first importance when deciding what type of bridge is needed.

An engineer does not need to be a geologist, but he does require to have a sufficient knowledge of the earth's crust to enable him to recognise when he is on dangerous ground. Reference to a geological survey map may provide a great deal of general information which can be used in conjunction with the more precise information obtainable from trial pits and bores. Occasionally it may be desirable to consult a geologist where the site has indications of being freakish, or where exceptionally heavy loads are to be carried as is the case with long-span bridges. Bores should almost always be taken to a depth considerably below the proposed foundation level. A safe rule is to take the bores to a distance below foundation level equal to the width of the foundation in feet multiplied by one and a half times the number of tons per square foot to be transmitted through the abutments or piers. Thus if the abutment width

is to be 8 ft. and the load per square foot 2 tons, the bores should be taken to a depth of 24 ft. below foundation level. This precaution is usually necessary as a safeguard against the presence of a soft underlying stratum which might cause settlement even though a considerable depth below foundation level. If such soft material is located and its depth is known, a wider foundation transmitting a smaller load per square foot to the ground immediately below it may obviate any danger, but occasionally a complete alteration of the bridge type proposed may prove necessary.

The comparatively new theory of soil mechanics lays down methods to assist in estimating probable settlements, but such methods are very rarely of practical value to the bridge engineer. It is, however, valuable to know what pressure is transmitted to the underlying strata, and how it is distributed. Pressure diagrams for many materials show that at considerable depths below the level of application of the load the pressures may be almost independent of

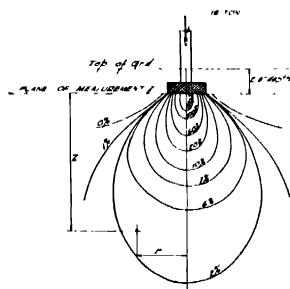

Pressure bulb for 16-ton load on 4-ft. by 4-ft. base.

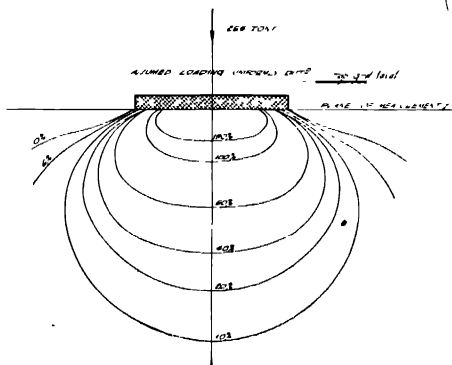

Pressure bulb for 256-ton load on raft foundation (16-ft. by 16-ft. base).

Fig. 150.

the width of footing for a given total load. Sufficient has been written here to indicate the dangers which may arise where foundations are constructed over a layer of soft material, and the reader is referred to one of the many books devoted to the subject. Typical pressure diagrams are given in *Fig. 150*; they are based on the assumption that the ground is uniform in-character throughout its depth, and such diagrams can never be more than a very approximate guide to the true distribution of pressure. It has been cynically suggested that the theory of soil mechanics has been developed to enable the engineer to describe in involved technical terms failures which could have been avoided by adequate preliminary investigation, but the new theories are valuable even if they merely indicate the dangers which can exist and the kind of preliminary research which may detect them.

### Cofferdams.

The spacing of piers for river crossings often provides complex and important problems greatly influencing the type and cost of a proposed bridge. River

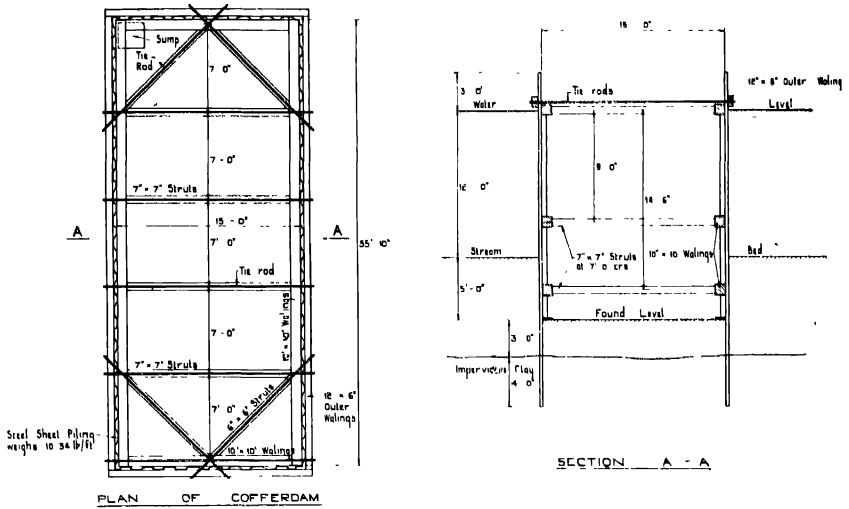

Fig. 151.—Typical Sheet-Pile Cofferdam.

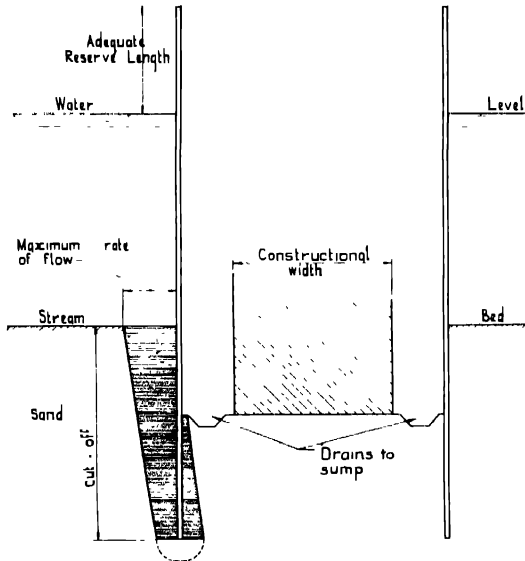

Fig. 152.—Sheet-Pile Cofferdam in Sand or similar Soil.

piers have generally to be constructed in cofferdams which may be difficult and slow to construct as well as expensive. The cost of constructing and maintaining a cofferdam and the provision of pumping is usually hard to estimate, as may be seen by referring to the items dealing with such works in competitive tenders. This is one reason for avoiding river piers for small bridges; another is the obstruction they will cause to the waterway, and the possible effect that this may have on the river banks. When estimates indicate that there will probably be only a moderate increase in cost by eliminating piers, then it is usually wise to do so. Where river piers are clearly necessary the choice is usually between two piers or four, as an odd number of piers providing an even number of spans is generally considered to be unsatisfactory from the æsthetic viewpoint. In such a case it is usually fairly simple to ascertain which of the alternatives will be the more economical, and in general two piers will be required for widths of between 160 ft. and 300 ft., and four piers for widths between 350 ft.

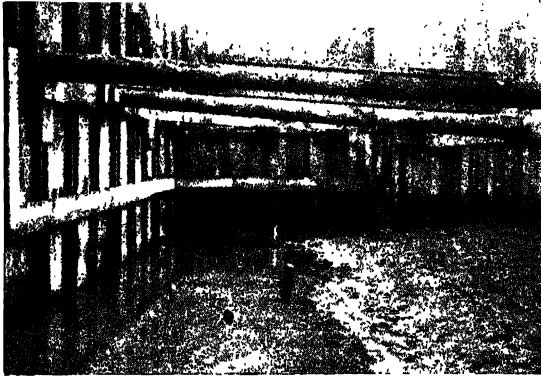
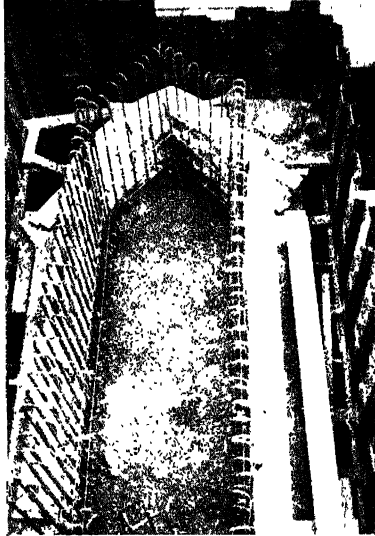

Fig. 153.—Cofferdam for Bridge Foundation.

and 500 ft. It is only rarely that rivers wider than 500 ft. will require to be considered without such important questions as navigational channels, etc., playing a decisive part.

Cofferdams are not usually designed by the consulting engineer, but he must be sufficiently familiar with their design and construction to enable him to assess the difficulties and cost of any such work which he may have to consider when making comparative estimates of cost. Most cofferdams are now constructed using steel sheet piling, and the piling firms generally have technical staffs available to advise regarding plant, costs and design. Typical details are given in *Fig. 151*. It will be seen that a clay stratum lies conveniently a few feet below the bed of the river, and very little trouble will be required to keep the excavation dry apart from small leakages through the sheeting. The case is very different when the material below the cofferdam consists of sand, or a mixture of sand with some clay, and much experience is required to deal adequately with such conditions. It is desirable to use sheet piling of adequate length so that the cut-off (see *Fig. 152*) can be increased in length, if necessary, to reduce

the rate of flow to the degree required to enable the pumps to control it. The pumping equipment should be adequate, and reserve pumps should always be available in case of a breakdown. Contractors often appear to take considerable risks, and the engineer can never be sure whether this is due to superior knowledge or blissful ignorance. In any event, the optimistic outlook influences the tender with the result that the work is cheapened, and as the contractor almost always has to pay for his own mistakes the engineer should not interfere unduly. Photographs of cofferdams for bridge works are shown in *Figs. 153 and 154*. The subject may be studied further by reading descriptions of works carried out which are published in technical journals.



**Fig. 154.**—Pier Construction within Cofferdam.

### Piling.

Load-bearing piles are frequently necessary in bridge foundations as the loads from piers and abutments are often considerable and only small even settlements are desirable. Whenever poor bearing soil is encountered near the surface, and strata of firm ground are found at depths of from 20 ft. to 40 ft., piling is usually fairly economical, rarely costing more than 10 per cent. of the complete bridge structure. The engineer has the choice of precast or in-situ piles and, in general, a decision on which should be employed should be based on cost. There are, however, occasions when most of the in-situ types of pile have distinct advantages over the precast pile; also, less frequently, when the latter is to be preferred. When the pile must depend almost entirely upon skin friction for its bearing value a precast pile will not carry as much load as some types of in-situ piles, and some of the latter are also helped by a club foot at the base. Some engineers have a prejudice against in-situ piling, and a claim



occasionally made is that the engineer cannot be sure that the minimum nominal section is always maintained. The safe load which can be imposed on precast piles may be calculated by one of several formulæ which do not all give the same results. It is sound practice to assess the total load which can be carried on a pile without appreciable settlement, and then provide a reasonable factor of safety by limiting imposed loads to about two-fifths of this amount. This means that a 14-in. square concrete pile between 30 ft. and 40 ft. long, driven by a hammer weighing 3 tons with a 4-ft. drop to a set of  $\frac{1}{4}$  in. to  $\frac{1}{8}$  in. for each of the last few blows, will safely carry 35 to 45 tons. The formula used will give a much closer value than this rough indication, but arithmetical accuracy will not enable one to get much closer to the true bearing capacity. When the safe bearing value of piles is in doubt a loading test can be made, but this is both expensive and delaying and is only occasionally necessary.

Most formulæ take the form  $R = \frac{\alpha Wh}{s + \beta}$ , where  $R$  is the ultimate bearing value,  $W$  is the weight of the hammer,  $h$  the drop, and  $s$  the set. ( $R$  and  $W$  are measured in the same units, usually tons, and  $h$  and  $s$  are also measured in the same units.) The constant  $\alpha$  depends upon the efficiency of the blow, and therefore upon the ratio of the weights of the hammer and the pile, as it is easy to see that a heavy hammer with a small drop is more effective than a lighter hammer with a long drop, although the product of weight by distance is equal in each case. The constant  $\beta$  is also dependent on the ratio of the weight of the pile to the hammer. The value of  $\alpha$  may usually be safely assumed as 0.45, and  $\beta$  as 0.4; the formula is then

$$R = \frac{0.45Wh}{s + 0.4}$$

If a double-acting steam hammer is used the value of its kinetic energy should be substituted for the term  $Wh$ . As an example, let  $W = 2\frac{1}{2}$  tons,  $h = 36$  in., and  $s = 0.2$  in., then  $R = \frac{0.45 \times 2\frac{1}{2} \times 36}{0.2 + 0.4} = 67.5$  tons.

It would therefore be safe to impose a load of from 27 to 30 tons on such a pile, providing a factor of safety of about  $2\frac{1}{2}$ . It is possible to work out the safe load by several different formulæ, but in the end the engineer must depend upon his own judgment, taking into account the nature of the superstructure. A typical pile detail is given in Fig. 155, and particular attention is drawn to the helical core shown in the pile head. This core is very important in assisting the head to withstand heavy driving.

### Bearing Value of Ground.

It is very important to be able to assess the safe bearing value of the ground, as this factor has considerable influence on the type of bridge which may be used, as well as on the foundation design. Table XXIII gives a list of safe loads which may be placed on almost every variety of soil, and few engineers would disagree greatly with the suggested values. Difficulties arise, however, when an endeavour is made to define the different kinds of material, and individual judgment has to be relied upon in most cases. In almost all materials it is

TABLE XXIII.  
ALLOWABLE BEARING VALUES ON SOILS.

|   | Safe load—ton<br>per sq. ft.  |
|---|-------------------------------|
| Silt, mud, quicksand, peat . . . . .                                    | 0— $\frac{1}{2}$              |
| Alluvial soil, muddy clay . . . . .                                     | $\frac{1}{2}$ — $\frac{1}{2}$ |
| Soft clay and wet sand . . . . .  | $\frac{1}{2}$ —1              |
| Moderately dry clay and fine sand . . . . .                             | 1— $1\frac{1}{2}$             |
| Soft argillaceous chalk . . . . .                                       | 1— $1\frac{1}{2}$             |
| Clay and sand in alternate layers . . . . .                             | $1\frac{1}{2}$ —2             |
| Firm dry clay or compact sand . . . . .                                 | 2 $\frac{1}{2}$ —3            |
| Hard white chalk or compact sand at great depth below surface . . . . . | 3 $\frac{1}{2}$ —4            |
| Coarse gravel, in deep excavations, or hard blue clay . . . . .         | 4—5                           |
| Boulder clay . . . . .  | 5—6                           |
| Firm shale . . . . .  | 6—7                           |
| Hard sandstone . . . . .  | 8—12                          |
| Whinstone, granite, etc . . . . .                                       | 12—20                         |

absolutely essential to place a concrete mat or blinding over the subsoil immediately it is exposed, thus preventing it from being churned up or softened by exposure to the elements. A minimum thickness of blinding of 4 in. is usual but this may have to be increased when it is difficult to excavate to a fair level bed.

The excavation should be inspected by the engineer prior to laying the blinding coat, and it is usual to keep the level of the excavations 6 in. above the final level so that the last few inches of material may be taken out in his presence.

### Foundations on Rock.

Where rock is found near the surface, and other circumstances are not unfavourable to the choice, an open-spandrel arch bridge will offer the most economical structure besides simplifying æsthetic problems. The Craighall Bridge on the Perth-Braemar road is a good example, and the general arrangement (Fig. 156) gives details of span, rise, road width, etc. This is a special case, presenting few problems, but it will be noticed that the bridge is skewed and that separate abutments have been provided for each of the arches. The foundations are given in Fig. 157. No particular difficulties were encountered during construction, and the low cost of the foundations resulted in a very cheap bridge. It is important when concreting mass abutments for arches that planes of cleavage are not formed, otherwise the horizontal component of the thrust may induce movement with serious consequences to the structure. So long as this point is kept in mind it is a simple matter to arrange stopping-off planes which will obviate any danger. The pressure transmitted to the rock in the Craighall Bridge was limited to 3 $\frac{1}{2}$  tons per square foot, which is of course very low for sandstone. Other factors than the bearing capacity of the rock governed the determination of the overall area of abutment.

### EXAMPLES OF BRIDGE FOUNDATIONS.

In the following pages descriptions and illustrations of bridges are given with special reference to the design and construction of their foundations. The examples selected include abutments for arch bridges and piers for girder bridges. The structures are all in Scotland, where the terrain is such that a wide variety



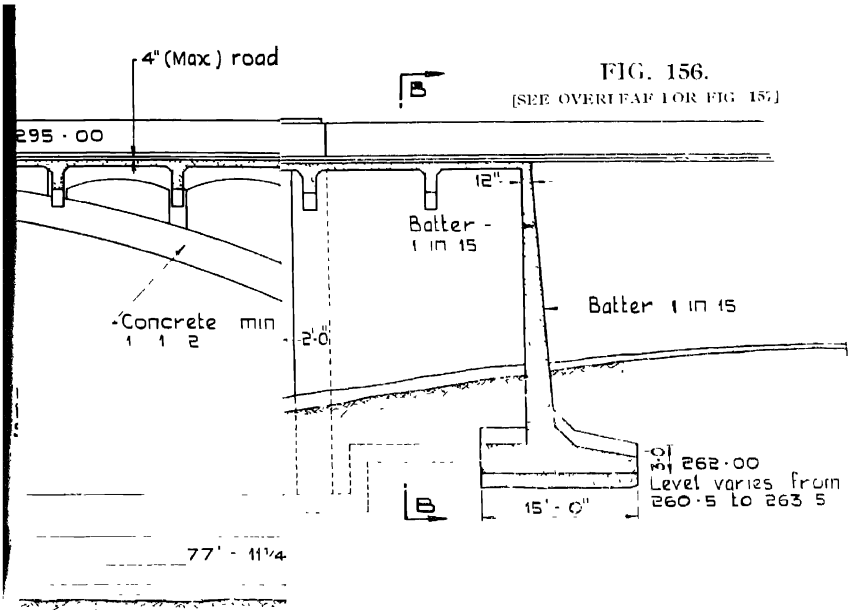

as

as a double CENTRE  
 should be sub  
 36 m., ar  
 It would  
 require a 77' - 6"

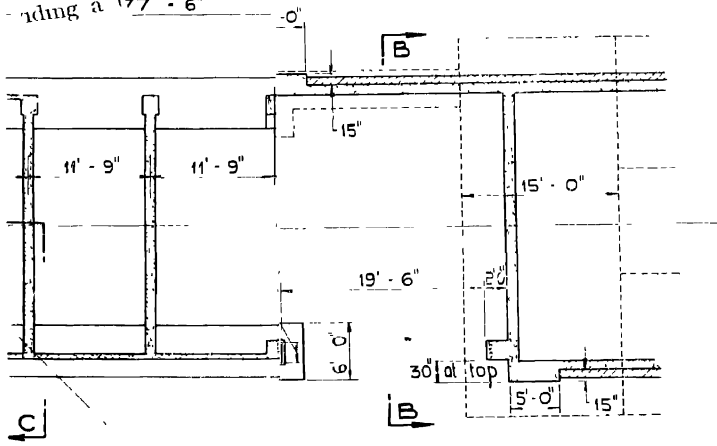
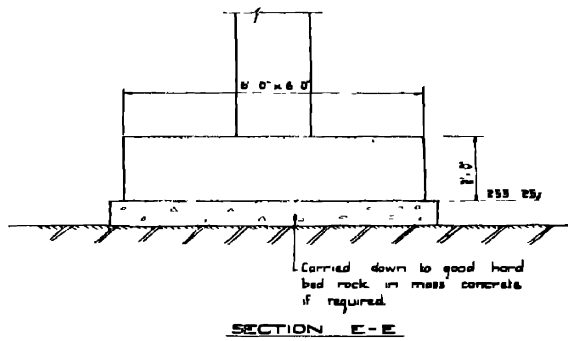
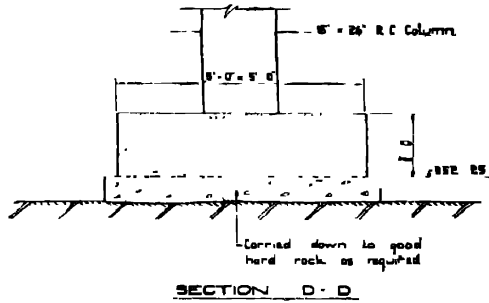

Fig. 156.—Cra... LEOD, COUNTY ROAD SURVEYOR, PERTH.

FIG. 157.



out Details of South Abutment.

FIG. 158.  
SEE OVERLEAF FOR FIG. 159]

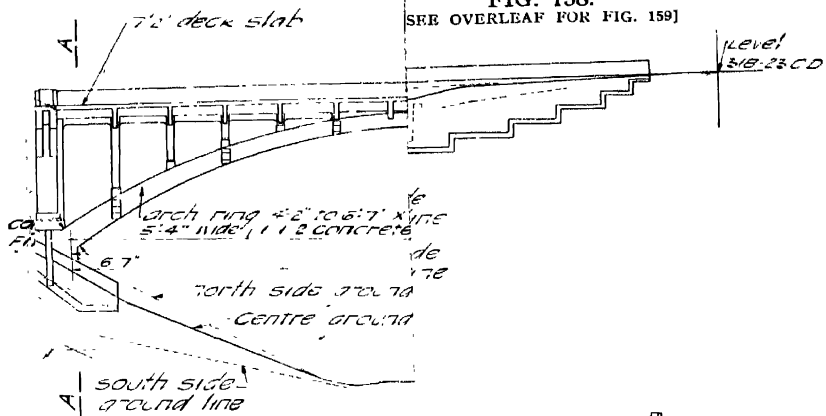

LONGITUDINAL

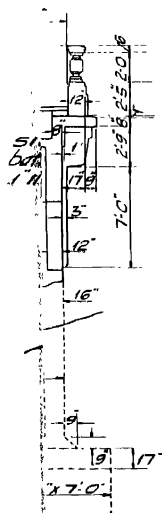
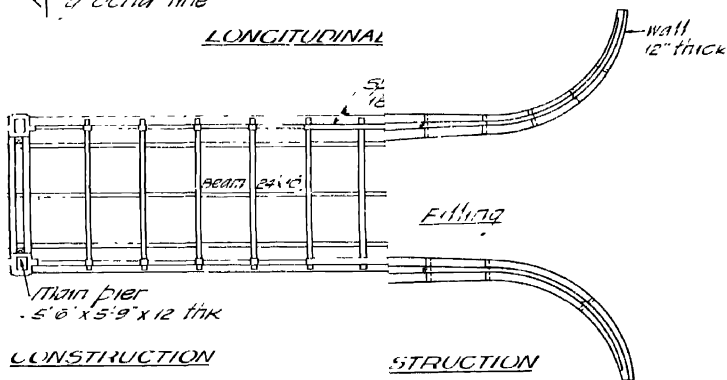
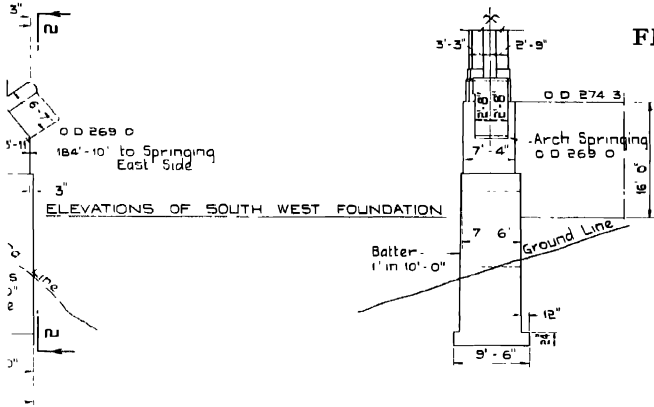
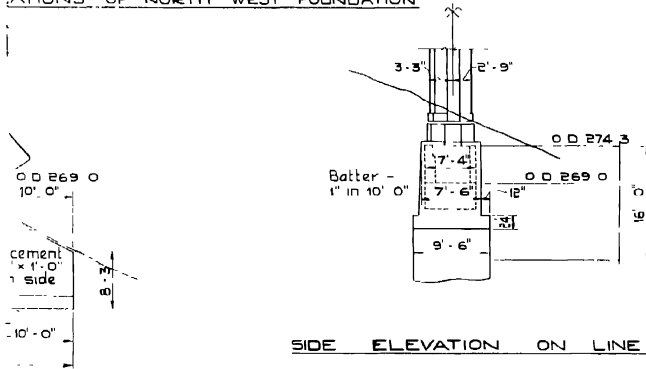

FIG. 159.



SIDE ELEVATION ON LINE 2-2

ELEVATIONS OF NORTH WEST FOUNDATION



SIDE ELEVATION ON LINE 3-3

line : Setting-out of West Foundations.

FIG. 160.

[SEE OVERLEAF FOR FIG. 161]

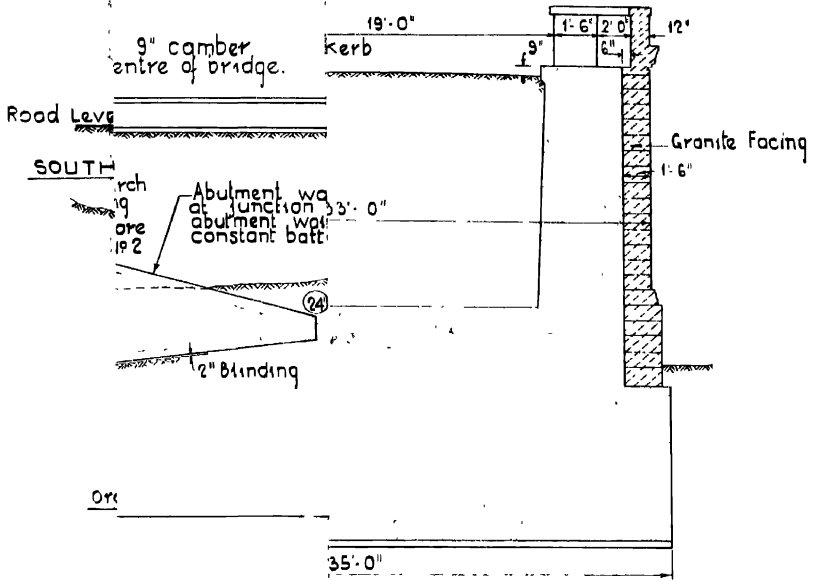

B-B.

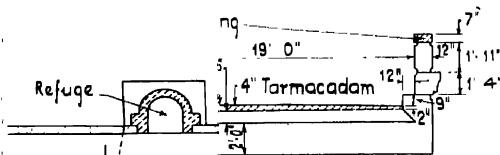

A-A.

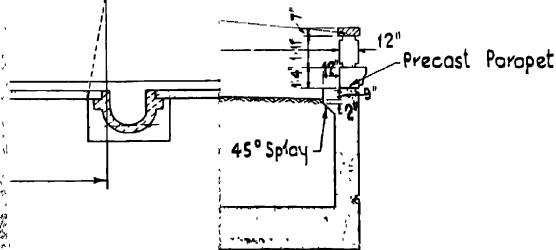

General Arrangement C.  
 COUNTY ROAD SURV



of problems of design and construction of bridges is encountered. Later in this chapter typical design calculations are given for two types of mass abutment and for abutments of the cellular type.

### Glen Bridge, Dunfermline.

An example of an open-spandrel arch bridge founded on rock is the Glen Bridge, Dunfermline, the general arrangement of which is indicated in *Fig. 158*; *Fig. 159* shows the arrangement of the west abutment. Here again the foundation costs were low, but the construction was not so simple as in the case of the Craighall Bridge. The steep slopes on either side of the valley were



**Fig. 162.**—Excavation for Abutment on a Slope.

well covered with earth, necessitating difficult excavation. *Fig. 162* shows the excavation for one of the abutments and indicates some of the constructional difficulties in working on a slope.

### Kemnay Bridge, Aberdeenshire.

Kemnay Bridge, in Aberdeenshire, provided a more difficult foundation problem than Craighall Bridge, due mainly to the relatively flat arch and the nature of the foundations. *Fig. 160* is the general drawing, and the details of the abutments are shown in *Fig. 161*. It will be observed that the abutment width is considerable, and comparatively heavy expenditure was incurred in the

construction of these foundations. The method of concreting the abutment in layers is shown, and it will be noticed that some reinforcement is indicated. Most designers consider that reinforcement can be dispensed with in arch abutments of this type, although in Kemnay Bridge the cost of foundation reinforcement was very small indeed in relation to the cost of the concrete. *Figs. 163*

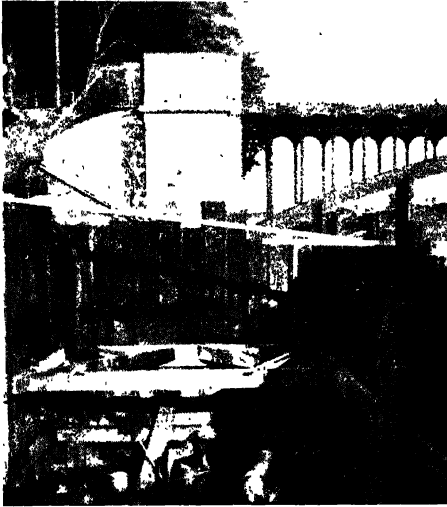

**Fig. 163.**—Abutment in Course of Construction, Kemnay Bridge.

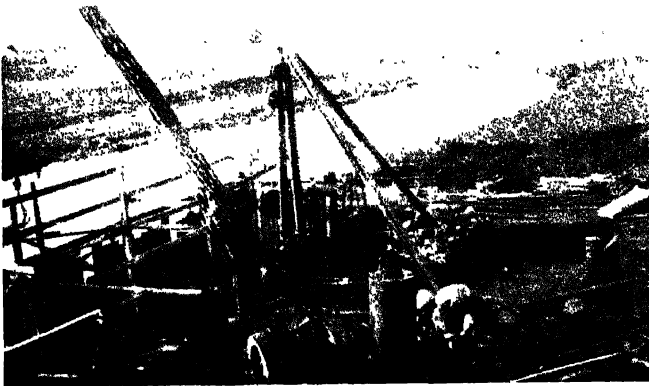

**Fig. 164.**—Abutment in Course of Construction, Kemnay Bridge.



165.  
 F FOR FIG. 166]

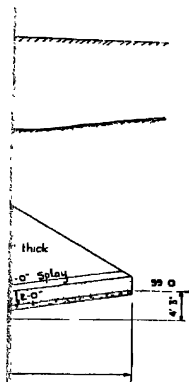

Vertical

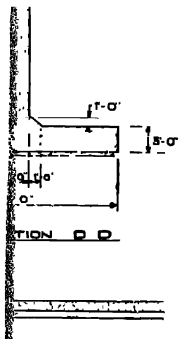

Flange Joint



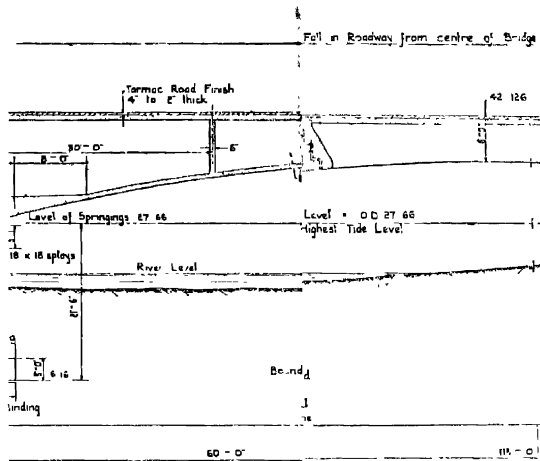

LONGITUDINAL SE

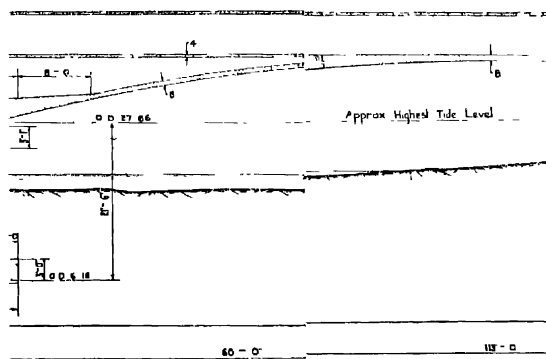

LONGIT

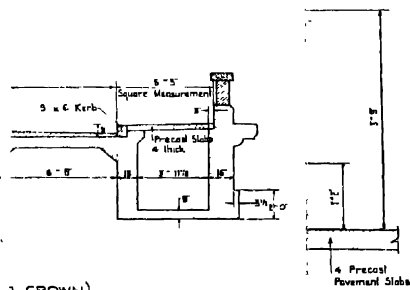

3 CROWN)

**Arrangement.**  
 R, ST. ANDREWS.

FIG. 167.  
 [SEE OVERLEAF  
 FOR FIG. 168]

FIG. 168.

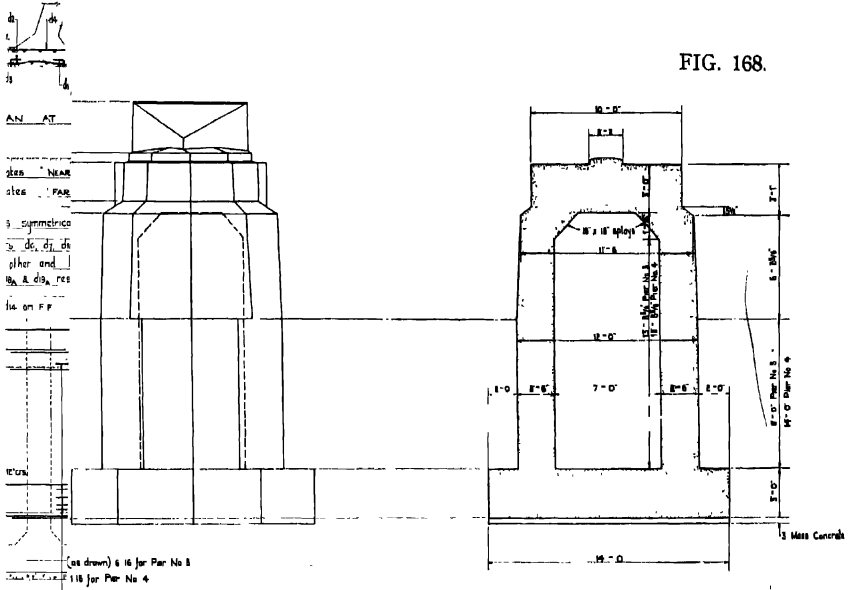

SECTION

NO ELEVATION OF PIER No 3

NO ELEVATION OF PIER No 4 IS SIMILAR

EXCEPT FOR DIFFERENT DEPTH  
OF FOUNDATION

TYPICAL CROSS SECTION OF PIER No 3

SECTION OF PIER No 4 IS SIMILAR EXCEPT FOR  
DIFFERENT DEPTH OF FOUNDATION.

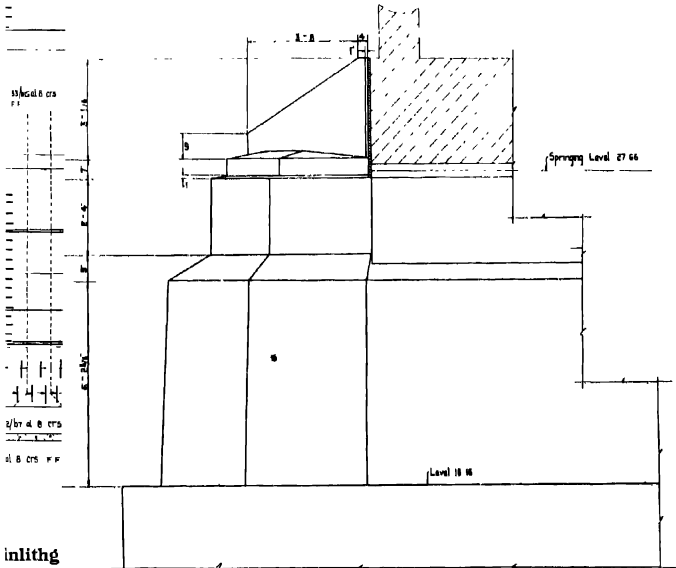

ENLARGED SIDE ELEVATION OF CUTWATER.

FIG. 173.



difficulty, and the stepping of the bases across the pier widths was varied in almost every pier. *Fig. 174* shows one of the excavations and *Fig. 175* the construction of the base of one pier. The foundations generally consisted of a fairly



**Fig. 174.**—Excavation for Pier, Inverbervie Bridge.

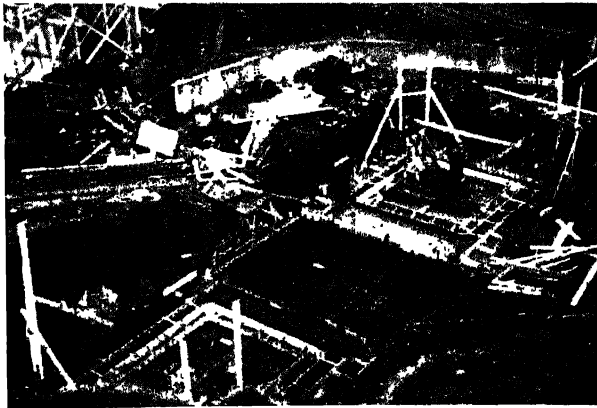

**Fig. 175.**—Construction of Base of Pier, Inverbervie Bridge.

hard gravel bed, but the excavations of one pier disclosed very different ground conditions and investigations indicated that a small ravine must have been there at one period. The ravine had gradually filled up, giving a very deceptive appearance at foundation level, but probing disclosed a layer of soft clay just







Fig. 177.—Aboyne Bridge: Reinforcement in Upper Portion of Abutment.

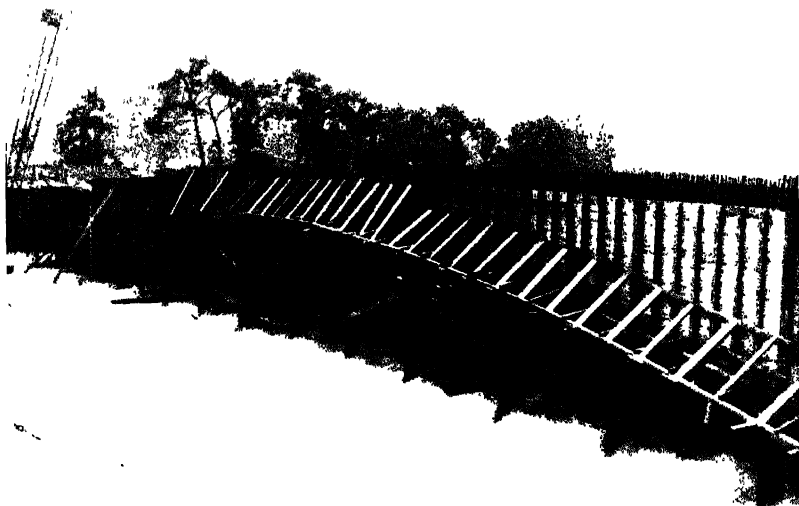

Fig. 178.—Aboyne Bridge: River in Flood during Construction.

| SECTION     | DT               | REINFORCEMENT | REMARKS                        |
|-------------|------------------|---------------|--------------------------------|
| SECTION A-A | FOUNDATION BLOCK |               | Bottom bars 2<br>4" x 24" dia. |
| SECTION B-B | FOUNDATION BLOCK |               | Bottom bars 2<br>4" x 24" dia. |
| SECTION C-C | FOUNDATION BLOCK |               | Bottom bars 2<br>4" x 24" dia. |
| SECTION D-D | FOUNDATION BLOCK |               | Bottom bars 2<br>4" x 24" dia. |

1-USE CONCRETE W/ 2% B. S. (BY VOLUME)  
 2-MIX FOR BLOCKS TO BE 1:2:4 (BY VOLUME)  
 3-DISTRIBUTION BARS 5 AND 7 TO BE #3 BARS  
 4-BACK OF CORNER IN POSITIONS AS SHOWN  
 5-USE BRASS -- BE READ IN CONNECTION  
 WITH SEE NO. 673  
 6-APPROX. P. SCHEM. VI BARS

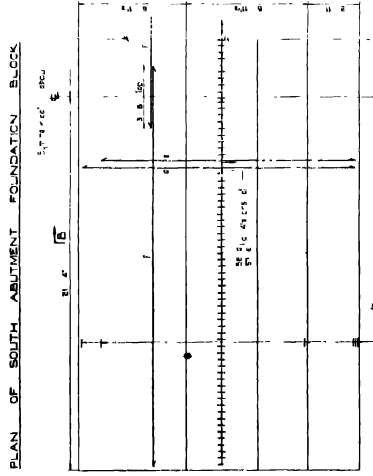
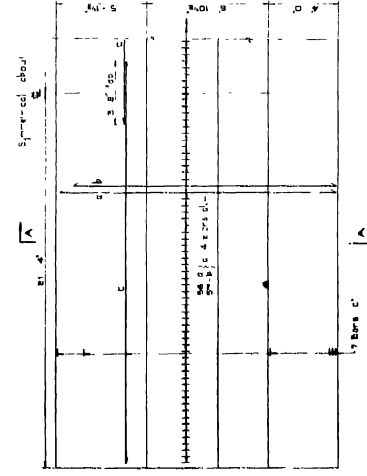
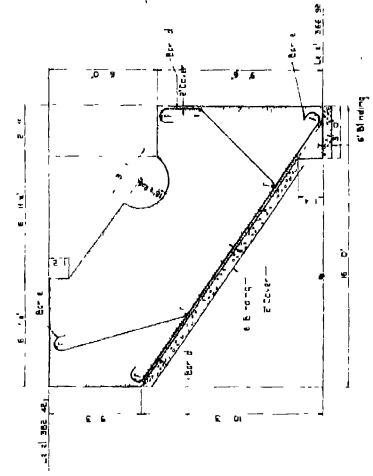
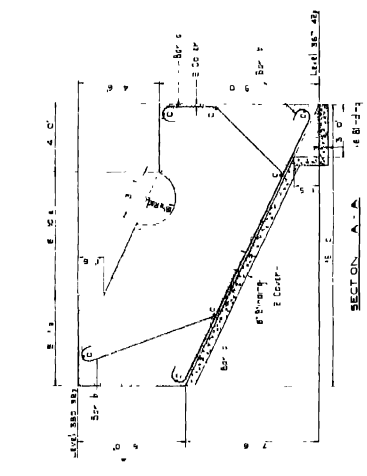

Fig. 179.—Abovne Bridge : Details of Foundation Blocks to North and South Abutments.



beneath. After investigation it was decided to a            The large ex  
involved in taking the piers down a further averag            . 14 ft., b  
of larch piles. Details of the construction are giv            *Fig. 176.*

### Aboyne Bridge.

A useful type of bridge where the minimum construction depth at t  
is required is the three-hinged portal, as used in the main span of a bri

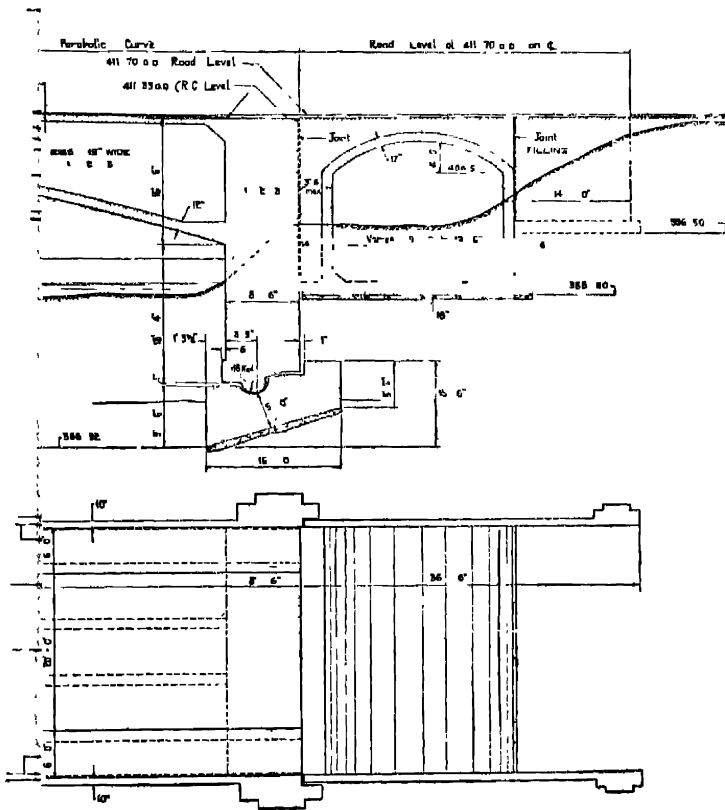

**Fig. 181.**—Cellular Abutment in Course of Construction, Redding Canal Bri

the river Dee at Aboyne. A longitudinal section through the bridge is giv  
*Fig. 182*, from which it will be seen that the entire weight from the main  
rests on the two semi-circular hinges. Details of the abutments are giv  
*Figs. 179* and *180*, but many of the splice bars in the soffit slab and ribs  
omitted from these drawings. The hinges have a radius of 18 in., and very  
compressive stresses occur in the concrete. The maximum compressive st  
is approximately 2840 lb. per square inch, when calculated from the H  
formula

$$c = \frac{3}{4} \left\{ \frac{pL}{\pi} \left( \frac{1}{r_1} - \frac{1}{r_2} \right) \right\}^{\frac{1}{2}}$$

FIG. 182  
 [SEE OVERLEAF  
 FOR FIG 183]



oved.

MR M. HEDDLE, B.Sc. A.M Inst.C E.,  
 COUNTY ROAD SURVEYOR, ABERDEEN.



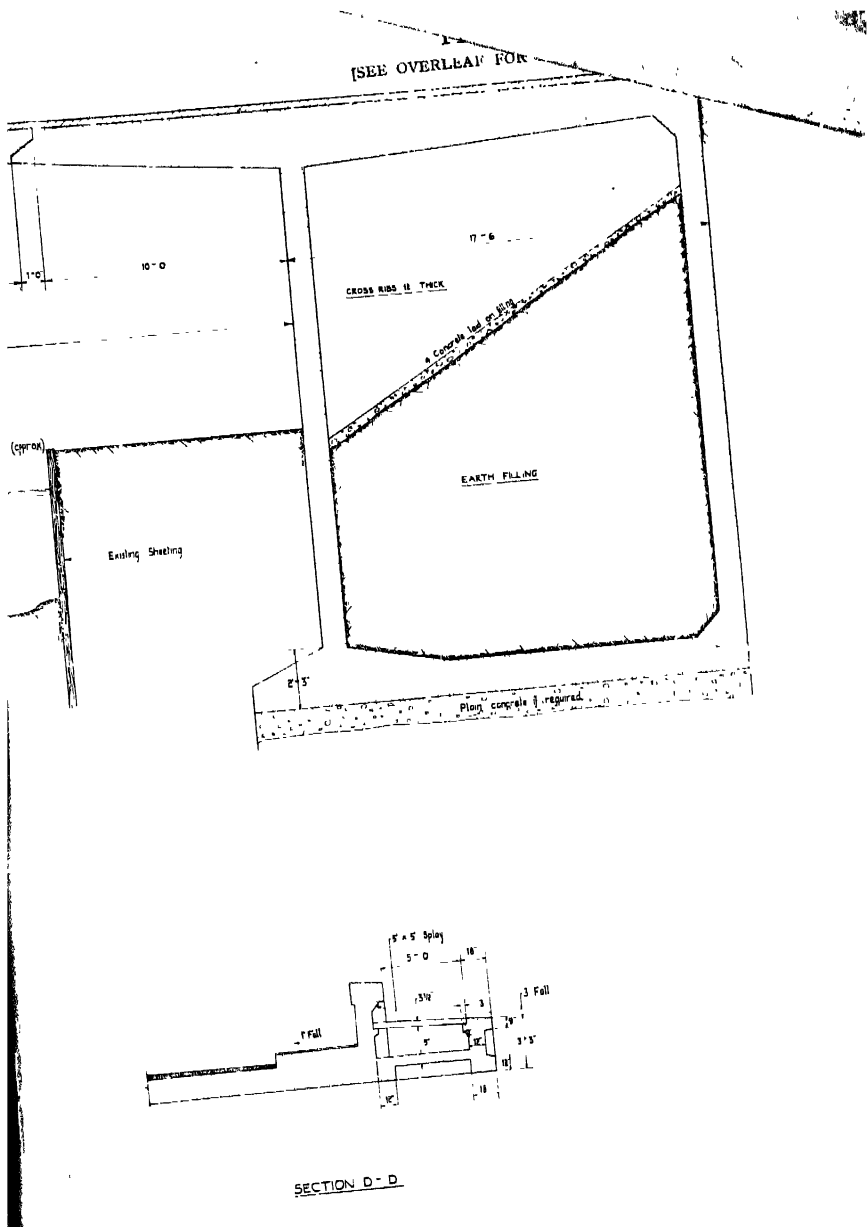

Fig. 184.—Redding Canal Bridge: Sections.  
 (SEE FIG. 183 FOR GENERAL ARRANGEMENT.)

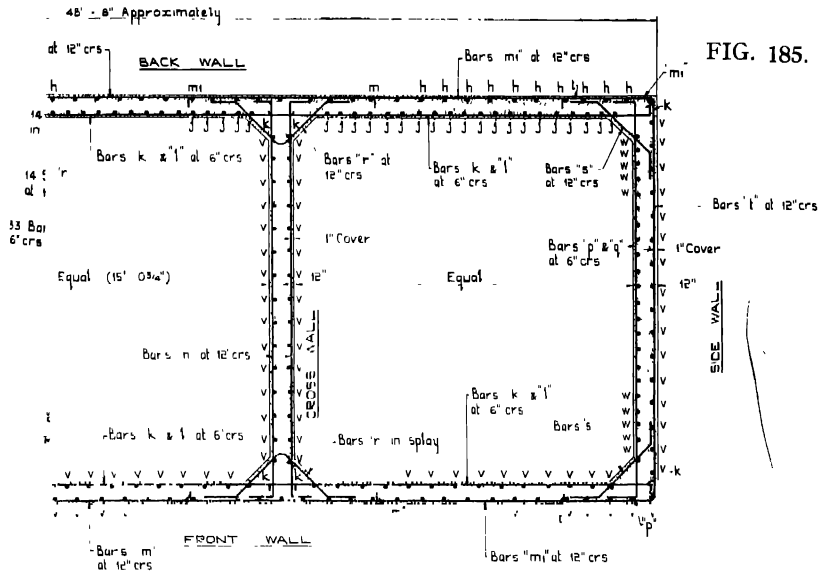

FIG. 185.

OF SOUTH ABUTMENT  
STEEL REINFORCEMENT IN WALLS OF  
CONSTRUCTION

**-Redding Canal Bridge : Details of South Cellular Abutment.**

NOTES:

- PROPORTIONS OF CONCRETE IN ABUTMENT BASE & WALLS  
1 : 2 : 3 BY VOLUME
- COVER TO BARS : 1" MINIMUM
- FOR METHOD OF SETTING-OUT OF ABUTMENT REFER  
TO DRG No 560-B
- FOUNDATIONS TO BE CARRIED DOWN BELOW 230 O.O.D  
LEVEL IN PLAIN MASS CONCRETE IF REQUIRED



OVERLEAF FOR FIG. 187]

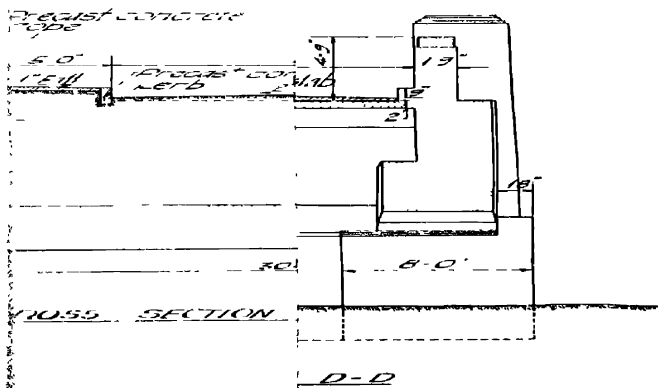
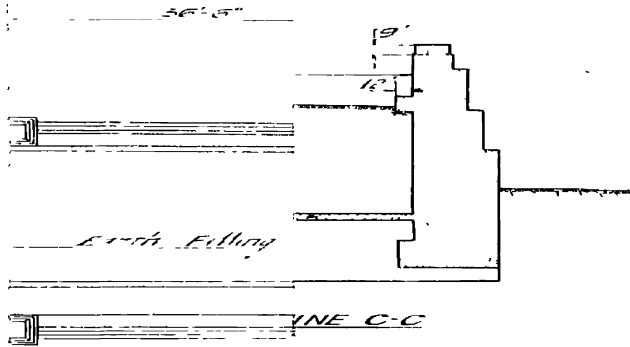
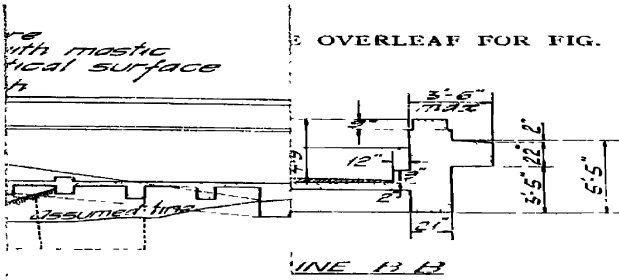

angement.  
ROAD SURVEYOR.

FIG. 187.

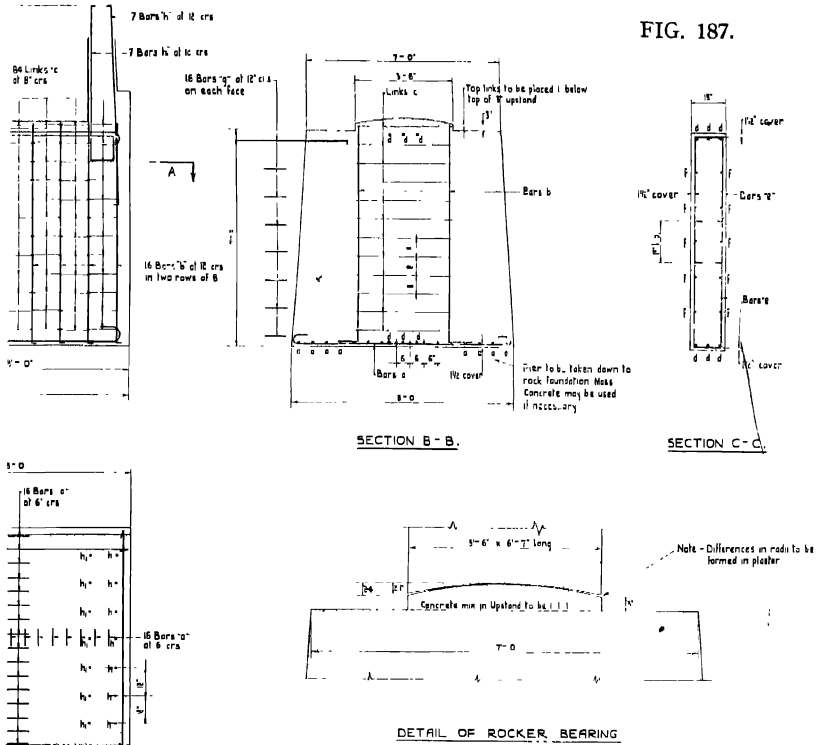

CONCRETE MIX TO BE 1 : 1 : 2

FOUND AT LEVEL SHOWN, THE PIERS MUST BE TAKEN DOWN IN MASS CONCRETE  
 ALL BARS TO BE WELL WIRED TOGETHER AT JUNCTIONS & INTERSECTIONS  
 SPECIAL CARE TO BE TAKEN TO SEE THAT THE ENDS OF ALL TIE WIRE  
 ARE TURNED INTO THE BODY OF THE WORK

| REMARKS   |
|---|
| 16m bars in Pier of 6" dia<br>h way                                 |
| 16m bars in Pier  |
| 16m bars of 6" dia<br>h way   |
| 16m & bottom bars in 15' wall<br>between Pier Blocks                |
| 16m bars of 6" dia in 15' wall<br>between Pier Blocks               |
| 16m bars of 12" dia on each<br>side of 15' wall between Pier Blocks |
| 16m bars to 6" wall of 12" dia<br>on each face                      |
| 16m bars to top of Pier of 12" dia<br>on outer face                 |

Fig. 187.—Dinnet Bridge: Details of Foundations and Piers.

where  $p$  = pressure (lb.) per unit length of hinge,  
 $r_1$  and  $r_2$  = radii (in.) of the surfaces in contact,  
 and  $E$  = modulus of elasticity of the concrete.

The calculated stress provides a factor of safety of about 2.2 on the high-strength concrete used. *Fig. 177* shows the reinforcement in the upper portion of the abutment, and the peaceful nature of the river will be observed. A contrast is provided by *Fig. 178*, which shows the river in flood at a later stage of the construction.

#### Redding Canal Bridge.

A very difficult bridge to design and construct is illustrated in *Figs. 183, 184, and 185*. It will be observed that it is on a curve, besides having an angle of skew of more than 50 deg. To make it more difficult, headroom was of paramount importance and only a small construction depth was available. Fortunately the span was small, and the problem was solved by the system shown on the drawings, using cellular counterweight abutments and a free partial span with joints suitably placed. The cellular abutments in the course of construction are shown in *Fig. 181*. It was known that in providing cofferdams the steel sheet piling would penetrate the clay-puddle seal in the canal bottom, and when the sheeting was withdrawn suitable measures had to be taken to make good the gaps in the clay.

#### Dinnet Bridge.

The arrangement and general details of a bridge constructed over the Dec are shown in *Figs. 186 and 187*. This bridge consists of cantilever parapet girders with counterweight abutments and a free mid-span portion. In order to avoid staging from the rocky bed of a fast-flowing river, which at flood times becomes

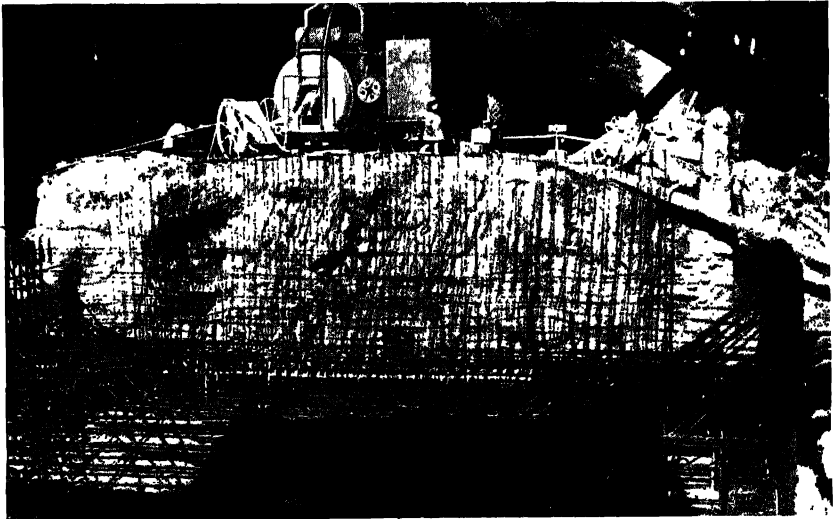

**Fig. 188.**—Reinforcement in Abutment, Dinnet Bridge.

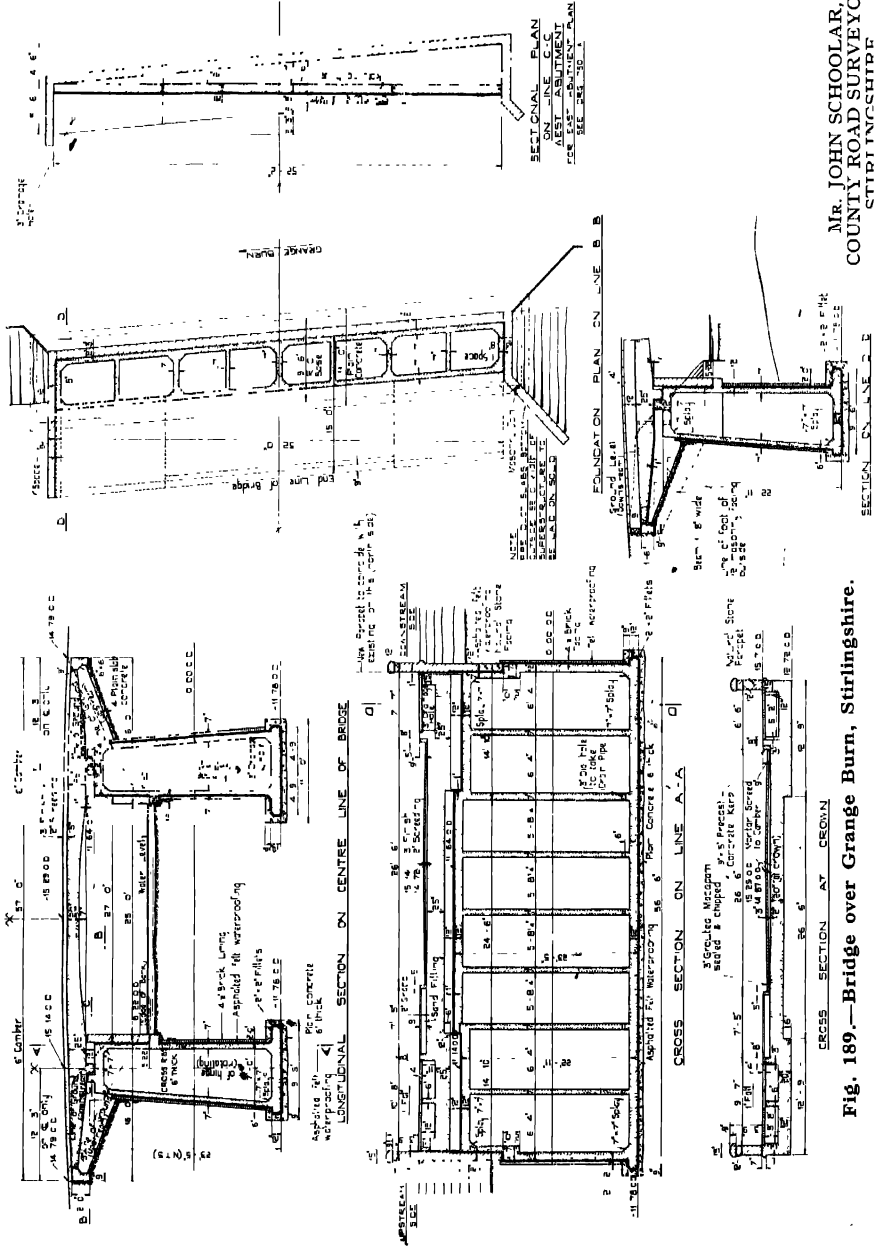

MR. JOHN SCHOOLAR,  
COUNTY ROAD SURVEYOR,  
STIRLINGSHIRE

Fig. 189.—Bridge over Grange Burn, Stirlingshire.

raging torrent, steel lattice girders were cantilevered out to provide supports for shuttering and were finally built in to the structure. The cantilever girders are supported on hinged bearings on the top of foundation blocks carried down to hard whinstone. The maximum pressure on the rock from the foundations is  $5\frac{1}{2}$  tons per square foot. Tie walls are provided between the foundation blocks, and the necessary counterweight is supplied by filling supported in a cellular construction immediately behind the hinge. Reinforcement details of the foundations are shown in *Fig. 187*, and a photograph of the reinforcement placed in the north abutment ready for concreting in is given in *Fig. 188*. The maximum compressive stress at the hinge calculated by the Hertz formula was 2500 lb per square inch.

### Bridge over Grange Burn.

Small bridges on abnormally bad ground may occasionally be built using deep cellular foundations so designed that the weight of the excavated material is equal to the load imposed on the ground by the new structure. This method was adopted for a small bridge constructed near Grangemouth, details of which are given in *Fig. 189*. The ground at the bed of the stream is a silty clay which becomes softer 2 ft. or 3 ft. below the surface, and then continues down to depths of 100 ft. or more. Normal bridge design would be completely unsatisfactory on such a site, but the method used has proved completely successful. Attention is drawn to the flexible nature of the superstructure, which was designed to prevent damage to it due to limited foundation movements of any kind. The problem was complicated by the stone facing which necessitated careful attention to the joints in order to avoid unsightly cracks. Particular care was taken to ensure that the cellular foundations were perfectly watertight, as water penetrating into one of the abutments might result in a large settlement due to the increased load on the ground. The maximum ground pressure is approximately 16 cwt. per square foot.

### Kerse Bridge.

Kerse Bridge, near Grangemouth, had to be built with difficult site conditions. Bores disclosed that the ground consisted of 5 ft. of mud and stones, then 3 ft. of sand and gravel, and finally 83 ft. of soft silty clay. This condition existed over the whole area of the site, and as boring was not carried farther the soft silty clay may extend to a considerably greater depth. Special treatment was evidently required, and what is believed to be a new type of "collar" pile was produced. A tapered pile was constructed to the dimensions shown in *Fig. 190*, which also gives the details of the collar. A collar was laid on the mud, and a pile was driven quite easily until the swelling on the pile made contact with the inner ring of the collar. After this resistance to penetration increased considerably, but many of the collars were driven more than 5 ft. into the ground before a satisfactory set was obtained. A loading test was carried out on one of the piles (*Fig. 194*). When a load of 90 tons had been placed a settlement of  $\frac{1}{8}$  in. was recorded immediately, and after leaving the load on for two weeks a further  $\frac{1}{4}$  in. of settlement was measured. The load was then reduced to 75 tons without change, and no further settlement occurred during the next two weeks. This test was considered satisfactory, and a design was prepared

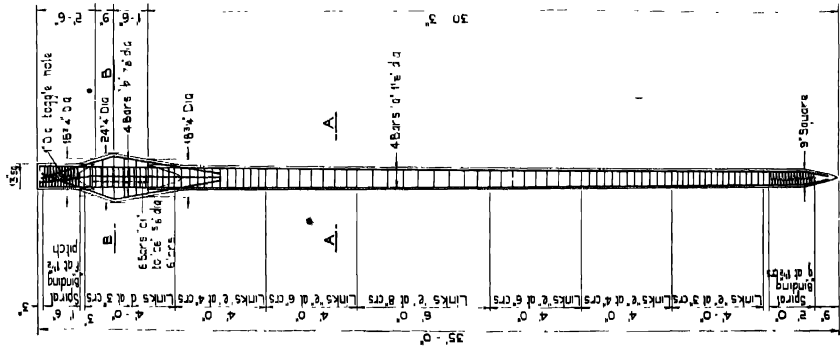

| NO. | REINFORCEMENT | LEVEL      | BENDING    | REMARKS        |
|-----|---------------|------------|------------|----------------|
| 1   | 18 1/2 Dia    | 18 1/2 Dia | 18 1/2 Dia | 4 Bars 1/2 Dia |
| 2   | 18 1/2 Dia    | 18 1/2 Dia | 18 1/2 Dia | 4 Bars 1/2 Dia |
| 3   | 18 1/2 Dia    | 18 1/2 Dia | 18 1/2 Dia | 4 Bars 1/2 Dia |
| 4   | 18 1/2 Dia    | 18 1/2 Dia | 18 1/2 Dia | 4 Bars 1/2 Dia |
| 5   | 18 1/2 Dia    | 18 1/2 Dia | 18 1/2 Dia | 4 Bars 1/2 Dia |
| 6   | 18 1/2 Dia    | 18 1/2 Dia | 18 1/2 Dia | 4 Bars 1/2 Dia |
| 7   | 18 1/2 Dia    | 18 1/2 Dia | 18 1/2 Dia | 4 Bars 1/2 Dia |
| 8   | 18 1/2 Dia    | 18 1/2 Dia | 18 1/2 Dia | 4 Bars 1/2 Dia |
| 9   | 18 1/2 Dia    | 18 1/2 Dia | 18 1/2 Dia | 4 Bars 1/2 Dia |
| 10  | 18 1/2 Dia    | 18 1/2 Dia | 18 1/2 Dia | 4 Bars 1/2 Dia |
| 11  | 18 1/2 Dia    | 18 1/2 Dia | 18 1/2 Dia | 4 Bars 1/2 Dia |
| 12  | 18 1/2 Dia    | 18 1/2 Dia | 18 1/2 Dia | 4 Bars 1/2 Dia |
| 13  | 18 1/2 Dia    | 18 1/2 Dia | 18 1/2 Dia | 4 Bars 1/2 Dia |
| 14  | 18 1/2 Dia    | 18 1/2 Dia | 18 1/2 Dia | 4 Bars 1/2 Dia |
| 15  | 18 1/2 Dia    | 18 1/2 Dia | 18 1/2 Dia | 4 Bars 1/2 Dia |
| 16  | 18 1/2 Dia    | 18 1/2 Dia | 18 1/2 Dia | 4 Bars 1/2 Dia |
| 17  | 18 1/2 Dia    | 18 1/2 Dia | 18 1/2 Dia | 4 Bars 1/2 Dia |
| 18  | 18 1/2 Dia    | 18 1/2 Dia | 18 1/2 Dia | 4 Bars 1/2 Dia |
| 19  | 18 1/2 Dia    | 18 1/2 Dia | 18 1/2 Dia | 4 Bars 1/2 Dia |
| 20  | 18 1/2 Dia    | 18 1/2 Dia | 18 1/2 Dia | 4 Bars 1/2 Dia |
| 21  | 18 1/2 Dia    | 18 1/2 Dia | 18 1/2 Dia | 4 Bars 1/2 Dia |
| 22  | 18 1/2 Dia    | 18 1/2 Dia | 18 1/2 Dia | 4 Bars 1/2 Dia |
| 23  | 18 1/2 Dia    | 18 1/2 Dia | 18 1/2 Dia | 4 Bars 1/2 Dia |
| 24  | 18 1/2 Dia    | 18 1/2 Dia | 18 1/2 Dia | 4 Bars 1/2 Dia |
| 25  | 18 1/2 Dia    | 18 1/2 Dia | 18 1/2 Dia | 4 Bars 1/2 Dia |
| 26  | 18 1/2 Dia    | 18 1/2 Dia | 18 1/2 Dia | 4 Bars 1/2 Dia |
| 27  | 18 1/2 Dia    | 18 1/2 Dia | 18 1/2 Dia | 4 Bars 1/2 Dia |
| 28  | 18 1/2 Dia    | 18 1/2 Dia | 18 1/2 Dia | 4 Bars 1/2 Dia |
| 29  | 18 1/2 Dia    | 18 1/2 Dia | 18 1/2 Dia | 4 Bars 1/2 Dia |
| 30  | 18 1/2 Dia    | 18 1/2 Dia | 18 1/2 Dia | 4 Bars 1/2 Dia |
| 31  | 18 1/2 Dia    | 18 1/2 Dia | 18 1/2 Dia | 4 Bars 1/2 Dia |
| 32  | 18 1/2 Dia    | 18 1/2 Dia | 18 1/2 Dia | 4 Bars 1/2 Dia |
| 33  | 18 1/2 Dia    | 18 1/2 Dia | 18 1/2 Dia | 4 Bars 1/2 Dia |
| 34  | 18 1/2 Dia    | 18 1/2 Dia | 18 1/2 Dia | 4 Bars 1/2 Dia |
| 35  | 18 1/2 Dia    | 18 1/2 Dia | 18 1/2 Dia | 4 Bars 1/2 Dia |

PLAN OF BEARING SLAB TO PILE

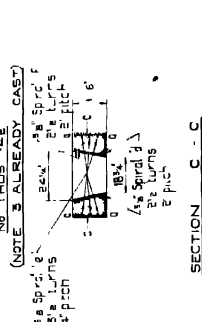

CONCRETE MIXTURE TO BE PART CEMENT TO 2 PARTS SAND TO 3 PARTS AGGREGATE TO 3 PARTS AGGREGATE TO BE GRADED FROM 3/4" TO 1/2" BARS TO HAVE 1" COVER OF CONCRETE

Fig. 190.—Details of Tapered Pile and Collar, Kerse Bridge.



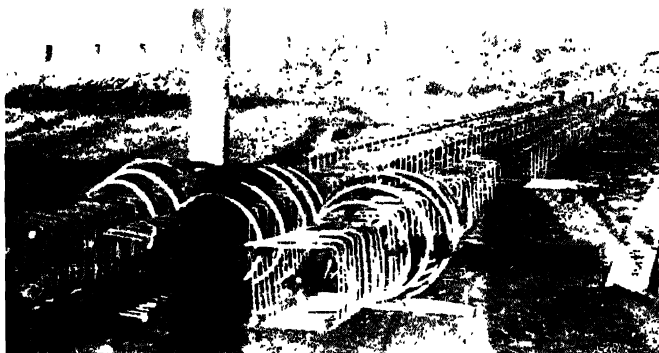

Fig. 192.—Reinforcement for Tapered "Collar" Piles, Kerse Bridge.

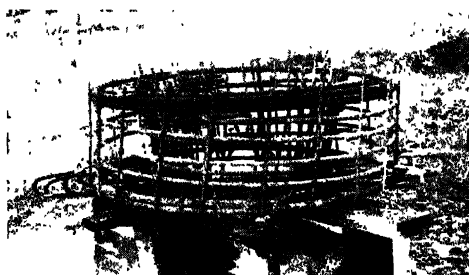

Fig. 193.—Reinforcement for Pile "Collar," Kerse Bridge.

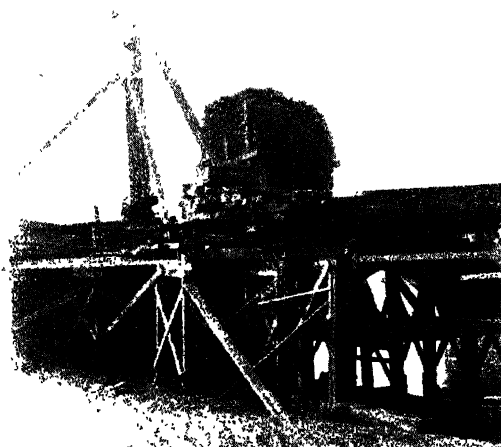

Fig. 194.—Loading Test on Pile, Kerse Bridge.





$V$  = the vertical component of the thrust of the arch for the same condition

$M_k$  = the positive moment at springing due to knife-edge load in the case of a continuous arch (zero for a hinged arch)

$s$  = the surcharge on the roadway over the abutment

$w$  = the density of the filling over the abutment

$w'$  = density of the concrete or masonry of the abutment

$h_0$  = the assumed mean depth of the base to reach bearing strata below arch springing

$h_1$  = the mean depth of filling over the abutment obtained from a preliminary sketch

$h_2$  = the mean depth of the masonry of the abutment (from a sketch)

$h$  = the mean equivalent height of earth corresponding to filling, masonry, and surcharge =  $\frac{s + wh_1 + w'h_2}{w}$

$\phi$  = the angle of repose of the filling

$$k = \frac{1 - \sin \phi}{1 + \sin \phi}$$

$p$  = the allowable maximum pressure on the foundations (uniform)

$H'$  = the total active earth pressure on the foundation

$z$  = the height of the resultant of  $H'$  above the mean depth of the foundation

$M$  = the sum of the moments of the horizontal forces and the springing moment  
=  $Hh_0 + M_k$  if  $H'$  is neglected or  $Hh_0 + M_k - H'z$  if  $H'$  is included  
(in the case of a hinged arch  $M_k$  is zero)

$\theta$  = the angle between the resultant of all forces acting on base and the horizontal.

Writing  $d_0 = \left(h_1 + h_2 + \frac{s}{w} - h_0\right)$  and  $d_1 = \left(h_1 + h_2 + \frac{s}{w}\right)$ ,  $H' = \frac{1}{2}kw d_1^2$ ,  $z = \frac{1}{3}d_1$ ,

in the case where there is a curtain wall extending to the roadway.

$H' = \frac{1}{2}kw(d_1^2 - d_0^2)$ ,  $z = \frac{3d_1(d_1^2 - d_0^2) - 2(d_1^3 - d_0^3)}{3(d_1^2 - d_0^2)}$  in case the earth

pressure acts on the height  $h_0$ , or  $d_1 - d_0$ , only. To simplify the formulæ,

calculate  $a = \frac{V}{wh}$ ,  $b = \frac{p}{wh}$ , and  $m = \frac{M}{wh}$ .

Let  $x$  = the distance of the back of the abutment from the vertical through the springing

$y$  = the distance of the front of the abutment from the vertical through the springing.

Then  $x$  and  $y$  are given approximately by the equations

$$x = a \left\{ \sqrt{1 + \frac{2mb}{a^2}} - 1 \right\}$$

$$y = \frac{(b-1)x - a}{b}$$

These equations express the conditions that the allowable base pressure shall

be uniform over the base, and shall not exceed the allowable value of  $p$ , the rate of pressure on the ground.

The total vertical loading on the base is  $p(x - y)$ ; the total horizontal thrust is  $H - H'$ ; and  $\tan \theta = \frac{p(x - y)}{H - H'}$ .

The base should usually be sloped so far as is convenient on a line lying between the horizontal and a normal to the resultant given by the angle  $\theta$ , say, on a line  $ab$  in place of  $AB$ . Alternatively the base can be stepped to follow this line. The top of the base should be inclined at an angle with the horizontal rather less than the inclination of the resultant reaction at the springing; this must be inclined at an angle less than 15 deg. to 20 deg. unless the concrete is to be shuttered on top. In the case of a fixed arch it is usual to form the top of the abutment somewhat as shown by the dotted line so as to give a large increase in the stiffness adjacent to the springings.

If necessary the calculation for  $x$  and  $y$  can be repeated for the corrected values of  $h_1$  and  $h_2$ , taken from the section as now drawn from the values of  $x$  and  $y$ , and the height of the base taken at the back. The final section is to be checked as illustrated in the example following.

EXAMPLE.—In a three-hinged arch the conditions are as follows :

$H$  = horizontal component of the thrust, dead + full live load = 53,520 lb. per foot width.  
(including knife-edge load at crown)

$V$  = vertical component of the thrust for the same loads = 29,950 lb. per foot width.

$s$  = surcharge on roadway = 220 lb. per square foot.

$w$  = density of filling = 100 lb. per cubic foot.

$w'$  = density of concrete = 144 lb. per cubic foot.

$h_0$  depth from centre of springing to mean depth of base = 12 ft. 9 in.

Total depth from roadway to mean depth of base = 23 ft. 6 in.

From a tentative sketch  $h_1$  is assumed as 15 ft. and  $h_2$  as 8 ft. 6 in.

$$\text{Then } h = \frac{220 + 15 \times 100 + 8.5 \times 144}{100} = 29.4 \text{ ft. ;}$$

$$\phi = 35 \text{ deg. ; } k = \frac{1 - \sin \phi}{1 + \sin \phi} = 0.271 ;$$

$p$  = allowable rate of ground loading =  $2\frac{1}{2}$  tons per square foot = 5600 lb. per square foot.

Then  $d_0 = 15 \text{ ft.} + 8 \text{ ft. 6 in.} + \frac{220}{100} - 12 \text{ ft. 9 in.} = 12.95 \text{ ft.} = \text{depth of filling from roadway to springing.}$

$d_1 = 15 \text{ ft.} + 8 \text{ ft. 6 in.} + \frac{220}{100} = 25.7 \text{ ft.} = \text{depth of filling from roadway to base.}$

$$H' = \frac{1}{2} \times 0.271(25.7^2 - 12.95^2)100 = 6660 \text{ lb.}$$

$$z = \frac{3 \times 25.7(25.7^2 - 12.95^2) - 2(25.7^3 - 12.95^3)}{3(25.7^2 - 12.95^2)} = 5.6 \text{ ft.}$$



$$M = 53520 \times 12.75 - 6660 \times 5.6 = 644,700 \text{ ft. lb.}$$

Then  $a = \frac{29,950}{100 \times 29.4} = 10.2$ ;  $b = \frac{5600}{100 \times 29.4} = 1.91$ ; and

$$m = \frac{644,700}{100 \times 29.4} = 219$$

$$\therefore x = 10.2 \left\{ \sqrt{1 + \frac{2 \times 219 \times 1.91}{10.2 \times 10.2}} - 1 \right\} = 23.6 \text{ ft.} = 23 \text{ ft. } 7 \text{ in.}$$

$$y = \frac{0.91 \times 23.6 - 10.2}{1.91} = 5.9 \text{ ft.} = 5 \text{ ft. } 11 \text{ in.}$$

The total vertical loading on the base =  $2.5(23.6 - 5.9) \times 2240 = 99,000 \text{ lb}$

$$H - H' = 53,520 - 6,660 = 46,860 \text{ lb.}$$

$$\tan \theta = \frac{99,000}{46,860} = 2.1, \text{ and } \theta = 64\frac{1}{2} \text{ deg.}$$

The base will be sloped at an angle of 15 deg. 30 min., giving an angle of 80 deg. between the resultant and the base.

The section (*Fig. 19b*) is now checked as follows:

(1) Draw the curve of equivalent earth loading including the surcharge, the height at any section being

$$h = \frac{w \times \text{height of earth} + x' \times \text{height of concrete} + s}{w}$$

(2) Determine the resultant of the equivalent earth loading by taking moments or graphically. In the present case the resultant is 65,660 lb. acting at 11.85 ft. from the springing.

(3) Determine  $H'$  and  $z$  graphically from the diagram of active pressures. In the present case  $H' = 8,300 \text{ lb.}$  and  $z = 6.7 \text{ ft.}$

(4) Determine the resultant force acting on the base by means of a force polygon.

In the present case  $\theta = 64 \text{ deg. } 30 \text{ min.}$ , ( $64 \text{ deg. } 30 \text{ min.} + 15 \text{ deg. } 30 \text{ min.}$ ) = 80 deg.;  $\cos(90 \text{ deg.} - 80 \text{ deg.}) = 0.985$ ; and  $R = 105,600 \text{ lb}$  with a normal component  $N = 105,600 \times 0.985 = 104,000 \text{ lb.}$  acting practically at mid-point.

The width of the base on the slope is 18.4 ft., and the rate of pressure on the base =  $\frac{104,000}{2240 \times 18.4} = 2.52 \text{ tons per square foot}$  in place of 2.5 tons per square foot assumed.

From the force polygon  $\theta = 64 \text{ deg. } 30 \text{ min.}$ , agreeing with the approximate calculation.

In the construction of mass abutments stopping off planes of concreting necessarily occur in which the shearing resistance is probably low. The position of these planes, at least towards the springing, should be specified. The position of the top section and its formation can be determined in the following manner:

In the example, with the horizontal thrust  $H = 53,520 \text{ lb.}$  and allowing 40 lb. per square inch in shear, the required horizontal width  $SS'$  is

$\frac{53.520}{12 \times 40} = 112 \text{ in.} = 9 \text{ ft. } 4 \text{ in.}$  Taking  $M$  on the line  $SS'$  so that  $AM = MB$ ,  $AM$  being drawn at an angle of  $15^\circ$  deg. with the horizontal and  $MB$  perpendicular to the top line of the abutment,  $AMB$  is the stopping-off plane. No stopping-off planes should be allowed above this level, and the top section should be reinforced somewhat as shown.

Below this section the rate of shear stress diminishes rapidly and the inclination of the resultant forces on the section is well within the angle of friction, so that the formation of the planes is not of great importance. They should, however, in general be sloped up at  $15^\circ$  deg. towards the springing so that the resultants act as near the normal as possible. In the example the plane  $MB$  requires to be shuttered, while the concrete is allowed to take its natural slope  $\phi$  n  $AM$ .

### Evaluation of the Forces and Moments transmitted to the Foundation of a Hingeless Arch.

The values of  $H$ ,  $V$ , and  $M_k$  can be calculated with sufficient accuracy for preliminary design for the foundations as follows:

Let  $g_0$  = the unit loading at the crown including half the live load

$g_1$  = the unit loading at the springing including half the live load

$$m = \frac{g_1}{g_0}$$

$P$  = the concentrated knife-edge load at the crown

$h_0$  = the height of the springing above the middle-point of the base

$$H = \frac{(5g_0 + g_1)l^2}{48r} + \frac{\rho l^2}{16r} + \frac{0.26 Pl}{r}$$

$$V = (2g_0 + g_1)\frac{l}{6} + \frac{1}{2}\rho l + \frac{1}{2}P$$

$M_k$  = the positive moment at springing =  $CPl$ , where  $C$  can be assumed to be 0.060 for an open-spandrel arch and equal to 0.070 for a solid-filled arch.

Here it has been assumed that the arch has been set out for dead load plus half live load, and the moment at the springing due to half live loading over the whole span can be neglected. These equations are exact as regards the effect of the knife-edge load in the case of a three-hinged arch with  $M_k = 0$ ; in the case of a fixed arch the results will be slightly in excess since the maximum value of the positive moment is given. In case more accurate values are required these are given by

$$H = \frac{(112g_2 - 9g_0 - 13g_1)l^2}{720r} + \frac{\rho l^2}{16r} + \frac{0.26 Pl}{r}$$

$$V = \frac{(128g_2 - 66g_0 - 17g_1)l}{90} + \frac{1}{2}\rho l + \frac{1}{2}P$$

$M_k = CPl$  where  $C = 0.06$  or  $0.07$ , as before,

here  $g_0$  = rate of loading at the crown due to dead + half live load

$g_1$  = rate of loading at the springing due to dead + half live load

$g_2$  = rate of loading at the quarter-point due to dead + half live load.

In the case of hinged arches  $M_k = 0$ .

**Mass Abutment with Vertical Front Face.**

The calculation for this type is very simple and depends on the fact that the rate of loading on the ground under the front face of a frustrum of a rectangular prism depends only on the height of the front face and remains constant for any height of back face.

Let  $H$  = the horizontal thrust of the arch per foot width of abutment due to dead loading plus full live loading (including knife-edge loading)

$V$  = the vertical component of the thrust of the arch for the same condition

$M_k$  = the positive moment at the springing due to the knife-edge load (zero for hinged arch)

$s$  = the surcharge on the roadway over the abutment

$w$  = the density of the filling over the abutment

$w'$  = the density of the concrete or masonry of the abutment

$h_1$  = the depth of the filling over the back of the abutment

$h_2$  = the depth of the back of the abutment.

The values of  $h_1$  and  $h_2$  will not vary appreciably from the values given by a tentative sketch since they will depend only on the slope of roadway.

$h$  = the reduced height of the filling, masonry, and surcharge on the line of the back face =  $\frac{wh_1 + w'h_2 + s}{w}$

$h'$  = the corresponding reduced height on the line of the front face

$\phi$  = the angle of repose of the filling.

$$k = \frac{1 - \sin \phi}{1 + \sin \phi}$$

$p$  = the allowable maximum pressure on the foundations

$H'$  = the total active earth pressure

$z$  = the height at which  $H'$  acts above the base of the foundation

$M$  = the sum of the moments of the horizontal forces and the springing moment =  $Hh_0 + M_k$ , if  $H'$  is neglected, =  $Hh_0 + Mk - H'z$ , if  $H'$  is included

$\theta$  = the angle of the resultant of all forces acting on the base with the horizontal

$x$  = the required width of base.

For brevity, calculate  $a = \frac{V}{wh}$ ;  $b = \frac{p}{wh}$ ;  $m = \frac{M}{wh}$ ;  $a' = \frac{V}{wh'}$  and  $m' = \frac{M}{wh'}$ .

$$\text{Then } x = a \left\{ \frac{\sqrt{1 + \frac{6m(b-1)}{a^2}} - 1}{(b-1)} \right\}$$

or  $x = 2a' \left\{ \sqrt{1 + \frac{3m'}{2a'^2}} - 1 \right\}$  whichever is greater. The latter condition restricts

the resultant to within the middle-third of the base and only applies for high rates of ground loading.

EXAMPLE.—As in the former example, use  $H = 53,520$  lb.,  $V = 29,950$  lb.,  $s = 220$  lb. per square foot, and  $h_0 = 12$  ft. 9 in. From a preliminary sketch assume  $h_1 = 20.6$  ft.,  $h_2 = 2.7$  ft.,  $Mk = 0$  as the arch is hinged at the abutment.

## REINFORCED CONCRETE BRIDGES

Then  $h = (100 \times 20.6 + 144 \times 2.7 + 220) \div 100 = 26.7$  ft.

$p =$  allowable rate of ground loading  $= 2\frac{1}{2}$  tons per square foot  $= 5600$  lb. per square foot

$$H' = \frac{1}{2} \times 0.271 (25.5^2 - 12.75^2) \times 100 = 6600 \text{ lb.}$$

$$z = \frac{3 \times 25.5(25.5^2 - 12.75^2) - (25.5^3 - 12.75^3)}{3(25.5^2 - 12.75^2)} = 5.6 \text{ ft.}$$

$$M = 53,520 \times 12.75 - 6600 \times 5.6 = 644,700 \text{ ft. lb.}$$

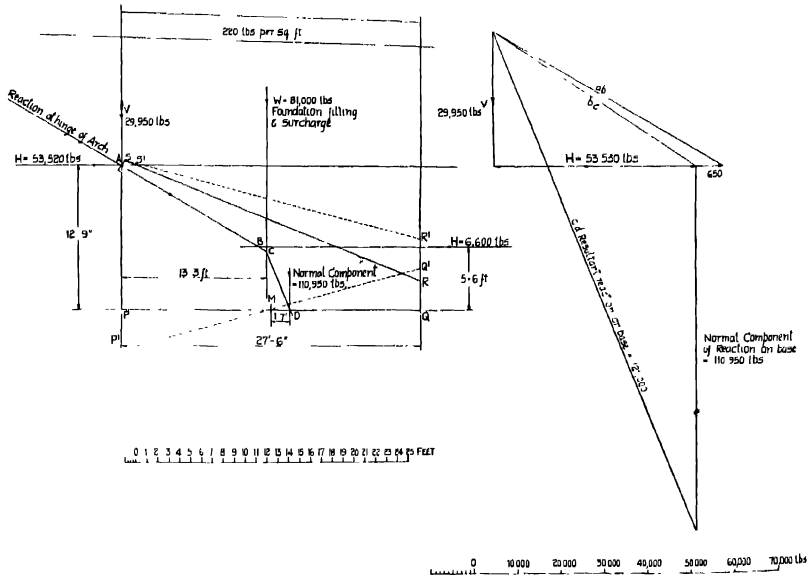

Fig. 197.

$$\text{Then } a = \frac{29,950}{100 \times 26.7} = 11.21; \quad b = \frac{5600}{100 \times 26.7} = 2.1; \quad \text{and } m = \frac{644,700}{100 \times 26.7} = 241.$$

$$\therefore x = 11.21 \left\{ \sqrt{1 + \frac{6 \times 241 \times 1.1}{11.21^2}} - 1 \right\} = 27 \text{ ft. 6 in.}$$

To verify the position of the resultant (with  $h_1 = 10.7$ ,  $h_2 = 13.1$ )

$$h' = (10.7 \times 100 + 13.1 \times 144 + 220) \div 100 = 31.8 \text{ ft.}$$

$$a' = \frac{29,950}{100 \times 31.8} = 9.44, \quad m' = \frac{644,700}{100 \times 31.8} = 203$$

$$x = 2 \times 9.44 \left\{ \sqrt{1 + \frac{3 \times 203}{2 \times 9.44^2}} - 1 \right\} = 20 \text{ ft. 8 in.}$$



The resultant therefore lies within the middle third for a base 27 ft. 6 in. wide (Fig. 197).

This result is checked graphically as follows from the diagram.

Weight of base =  $27.5 \times 8 \times 144 = 31,700$  lb.

Centre of gravity of base, by the usual graphical construction, is 10.8 ft. from the vertical through the springing.

Weight of filling and surcharge =  $27.5 \times 17.9 \times 100 = 49,300$  lb.

Centre of gravity of filling from the vertical through the springing = 14.9 ft.

Distance of resultant of weight of base, filling, and surcharge from the vertical through the springing

$$d = \frac{(27.5 \times 8 \times 144) + (27.5 \times 17.9 \times 100)}{31,700 + 49,300} = 13.3 \text{ ft.}$$

$$w = 31,700 + 49,300 = 81,000 \text{ lb.}$$

The force polygon having been drawn in Fig. 197 with directions  $ab$ ,  $bc$ , and  $cd$ , by drawing parallels  $AB$ ,  $BC$ , and  $CD$  the resultant on the base will be found to cut the base at 1.7 ft. from the middle point  $M$  of the base.

The normal component of the resultant =  $81,000 + 29,950 = 110,950$  lb. The maximum rate of loading on the base is then

$$p = \frac{110,950}{27.5} \left( 1 + \frac{6 \times 1.7}{27.5} \right) = 5570 \text{ lb.} = 2\frac{1}{2} \text{ tons per square foot as required.}$$

A section such as  $P'Q'R'S'$  (Fig. 197) will often be chosen in place of the section  $PQRS$ , since this gives a resultant more nearly perpendicular to the ground line.

Regarding the position of stopping-off planes, the same remarks apply as under Case I.

### Cellular Abutments.

In this type counterforts connected by a curtain wall, base slab, and top distributing beam, are employed in place of the usual mass construction. The counterforts are usually at about 7-ft. to 8-ft. centres, and it is clear that the fixation afforded by such a construction at the springing can only be a fraction of that afforded by a mass construction, since the relative moments of inertia of the various sections below the springing are so much smaller. The perfect fixation at the springing usually assumed in continuous arch design cannot be attained. For this reason the type seems only suitable in the case of three-hinged arches, where its employment may be very advantageous both on account of economy and the superiority of reinforced construction generally. If it is desired to use a cellular structure for continuous arches then the counterforts should be regarded as continuous with and part of the arch and designed accordingly. The design of a counterfort abutment can best be explained by means of an example (Fig. 198).

**EXAMPLE.**—A three-hinged arch is considered with  $H = 53,520$  lb. and  $V = 29,950$  lb. per foot width, and a surcharge on the roadway equal to 220 lb. per square foot. The allowable rate of ground loading assumed is  $2\frac{1}{2}$  tons per square foot. The following assumptions are also made :

Mean depth of foundation level below level of springing  $h_0 = 12$  ft. 9 in. and total mean depth of roadway to base level = 23 ft. 6 in.

Angle of repose of filling = 35 deg.

Density of filling  $w = 110$  lb. per cubic foot

Density of concrete  $w' = 150$  lb. per cubic foot.

Assuming an average weight of filling and concrete of 120 lb. per cubic foot,

$$h = [(23.5 \times 120) + 220] \div 110 = 27.7 \text{ ft.}$$

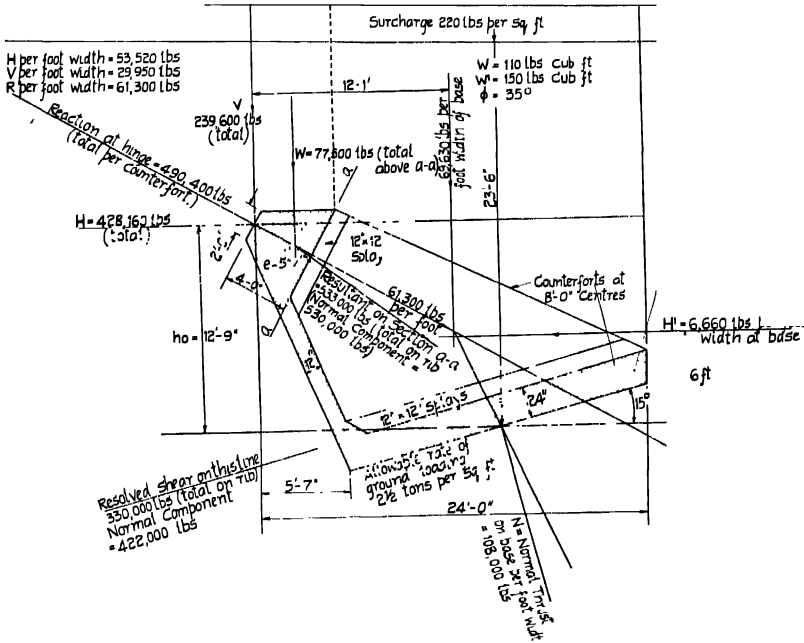

Fig. 198.

Then, as in the example under Case I,

$$H' = 6660 \text{ lb. ; } z = 5.6 \text{ ft. ; } M = 644,700 \text{ ft.-lb. ; } a = \frac{29,950}{110 \times 27.7} = 9.85,$$

$$b = \frac{5600}{110 \times 27.7} = 1.838, \quad m = \frac{644,700}{110 \times 27.7} = 21.2.$$

$$\therefore x = 9.85 \left\{ \sqrt{1 + \frac{2 \times 21.2 \times 1.838}{9.85^2}} - 1 \right\} = 24 \text{ ft.}$$

$$y = \frac{0.838 \times 24 - 9.85}{1.838} = 5.6 = 5 \text{ ft. 7 in. say.}$$

Assume, provisionally, counterforts 12 in. thick at 8-ft. centres, base slab

24 in. thick, curtain wall 12 in. thick, and top distributing beam 4 ft. deep. The base slabs will be sloped at an angle of 15 deg.

*Counterfort Ribs (12 in. wide at 8-ft. centres).*

|  |                  |
|--|------------------|
| Resultant thrust from arch = 61,300 × 8                      | lb.<br>= 490,400 |
| Weight of concrete above plane <i>aa</i> = 4.7 × 4 × 8 × 150 | = 22,500         |
| Weight of filling and surcharge above plane <i>aa</i>        |                  |
| = 5 × 12.5 × 8 × 110   | = 55,000         |
|  | 77,500           |

From a diagram of forces the resultant on plane *aa* = 533,000 lb.

Normal component of the resultant on plane *aa* = 530,000 lb.

The component acts at 5 in. from the centre of the section *aa*, which is 7.4 ft. in width = 89 in., say, by scale.

Maximum stress in section *aa*,

$$c = \frac{530,000}{12 \times 89} \left( 1 + \frac{6 \times 5}{89} \right) = 665 \text{ lb. per square inch.}$$

Splices, 12 in. by 12 in., are placed at the top and bottom of the counterforts at their junctions with the top beam and the base slab.

The ratio of maximum length of counterforts to thickness is 18, so there is no risk of buckling. Placing about 0.8 per cent. of steel in the direction of the thrust, we get  $\frac{0.8 \times 12 \times 12}{100} = 1.15$  sq. in., or  $\frac{7}{8}$ -in. diameter bars at 12-in.

centres on both faces. From a triangle of forces the resolved shear along the junction of the counterfort and base slab (neglecting earth pressure) is 330,000 lb., and the normal thrust = 422,000 lb. Fifty-four sections of  $\frac{3}{8}$ -in. diameter links (= 5.95 sq. in.) are placed crossing the junctions of the base slab and counterfort at 45 deg. with an assumed working stress of 16,000 lb. per square inch.

|  |                  |
|--|------------------|
| Shear resistance of links = 5.95 × 16,000 √2                 | lb.<br>= 135,000 |
| Allow for reduction of diagonal tension due to normal thrust |                  |
| $\frac{1}{2} \times (422,000)$                               | = 211,000        |
|  | 346,000          |

as against the applied shear of 330,000 lb.

In the foregoing calculations the diagonal tension in the concrete has been neglected on account of the construction plane at the junction of the counterforts and base. It is questionable whether the full value of the normal thrust might not be allowed as reducing the diagonal tension effect of the shear force.

*Top Distributing Beam.*

Span *l* = 8 ft. ; total normal load *W* = 530,000 lb.

The calculation will be made for the end span, and the same area of steel used throughout.

|  |             |
|--|-------------|
| Positive moments in end spans                  | in. lb.     |
| $M = .530,000 \times 8 \times 0.078 \times 12$ | = 3,970,000 |

Negative moment over supports

$$M = 530,000 \times 8 \times 0.107 \times 12 = 5,450,000 \text{ in. lb.}$$

$$A = \frac{3,970,000}{13,600 \times 45} = 6.50 \text{ sq. in. (end spans)}$$

$$A = \frac{5,450,000}{13,600 \times 45} = 8.9 \text{ sq. in. (over supports)}$$

$$S = \frac{1}{2} \times 530,000 \times \frac{7}{8} = 232,000 \text{ lb.}$$

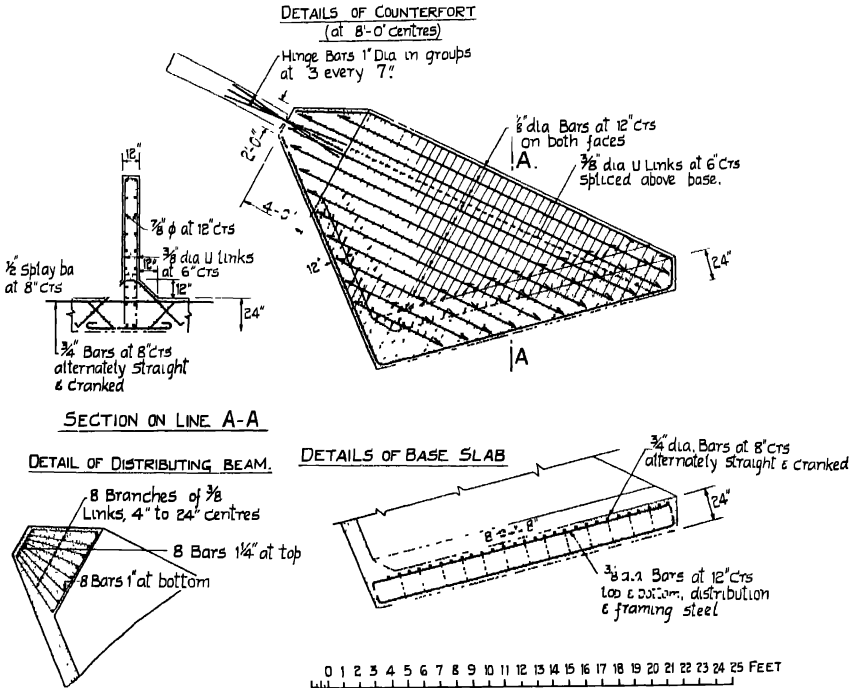

Fig. 199.

The steel used (Fig. 199) is eight 1-in. bars at the bottom continuous over all spans, eight 1 1/4-in. bars at the top continuous over all spans, and eight branches of 3/8-in. links at 4-in. to 24-in. centres.

|  |          |
|--|----------|
|  | lb.      |
| Concrete in shear $24 \times 45 \times 70$ | = 75,500 |

|   |           |
|---|-----------|
| Links $8 \times 0.11 \times \frac{45}{4} \times 16,000$ | = 158,000 |
|---|-----------|

|                                 |           |
|---------------------------------|-----------|
| Shear resistance                | = 234,000 |
| as against shear of 232,000 lb. |           |

*Base Slab.*—

|   |         |
|---|---------|
| The pressure on the base slab is found as follows :       | lb.     |
| Weight of counterfort (8-ft. centres) = 152 cb. ft. × 150 | 22,800  |
| Weight of top beam = 4·7 × 4 × 8 × 150                    | 22,500  |
| Weight of curtain wall = 9 × 8 × 1 × 150                  | 10,800  |
| Weight of base slab = 19·5 × 2 × 8 × 150                  | 46,900  |
| Weight of filling and surcharge = 4130 cb. ft. × 110      | 454,000 |
|   | 557,000 |

Total per foot of base =  $\frac{557,000}{8} = 69,630$  lb. acting at 12·1 ft. from the springing.

Thrust per foot width = 61,300 lb.

From a force diagram the resultant moment thrust to the base is found to be  $N = 108,000$  lb. acting at almost exactly the mid-point ; width of base 19·1 ft.

Rate of pressure on ground =  $\frac{108,000}{19·1} = 5650$  lb. per square foot or  $2\frac{1}{2}$  tons per square foot as required.

The maximum upward normal reaction at the toe of the base per square foot of base (cos 15 deg. = 0·966) is

$p = (5650 - 21·1 \times 110 \times 0·966 - 2 \times 150 \times 0·966) = 3110$  lb. per square foot, where 21·1 ft. is the height of filling and surcharge over the toe of the base.

$$M = 8^2 \times 3110 \times 1·0 = 199,000 \text{ in. lb.}$$

$$S = 3·5 \times 3110 = 10,900 \text{ lb.}$$

Gross rate of shear =  $\frac{10,900}{12 \times 22} = 41$  lb. per square inch, and no shear steel is required.

$$A = \frac{199,000}{13,600 \times 22} = 0·66.$$

Three-quarter-inch bars placed at 8-in. centres alternately straight and cranked are equivalent to 0·66 sq. in.

The curtain wall is calculated in the usual way for active earth pressure.

If the foregoing method of calculating the shearing resistance (by combining the resistances of the concrete and the links) is not permitted, the links should be more closely spaced, or their size increased, so that they can resist the whole of the shearing force.

## CHAPTER IX

### BRIDGE ARCHITECTURE

It is seldom that a good engineer is an equally good architect ; the converse will no doubt be admitted by most members of both professions. Bridge work, with all its problems of intricate stresses and strains, difficult foundations, and so forth, is primarily an engineering problem. At the same time bridges are important structures, frequently providing focal points in the landscape. Their appearance, therefore, whilst not affecting their utility, is of importance in preserving the amenities of the sites on which they are erected.

On viewing examples of reinforced concrete bridges, more particularly those carried out since the year 1918, one comes to the conclusion that there have been three different types of engineering outlook with regard to the architecture of bridges. The first ignored the appearance of the work so long as the structure was strong enough to carry its load. Such bridges provide the bare engineering necessities of the case, for example square columns, splays, finish straight from the shutters, and so on. There was evidently no attempt to adjust composition, proportions, and surfaces to obtain a more pleasing appearance. In the second, whilst taking care of strength and permanency, the engineer evidently wished to give some architectural appearance, and in doing so tried to produce something unusual and novel. The third was that of the engineer who cared equally with the first that strength and permanency should be sufficient, and equally with the second that the bridge should have a good appearance, but who at the same time did not necessarily strive for something entirely unlike previous works and took advantage of the lessons of bridge architecture of the past.

The first engineer frequently produced ugly structures. The second produced structures which occasionally, in certain situations, have proved satisfactory but in many cases are unsuited to the site. It takes time to change or to develop public taste, and the drastic differences in appearance between old stone bridges and some of the unusual elevations presented by concrete work of this kind have reacted to the detriment of concrete generally. The third engineer is now tending to lead modern thought on the subject, and it is to him we look for advancement and progress in the future.

Those who use it freely feel that concrete offers the possibility of structures more beautiful than any carried out since the best periods of masonry architecture, and the best work of recent years tends to confirm this view. This is logical, since the greater strength of concrete permits of slender sections with elegant lines and at the same time provides strength equal to that of masonry structures of far greater mass.

In the design of the largest bridges of recent years the engineer has been

allowed the services of a consulting architect in order to ensure the best æsthetic treatment of his purely engineering design. This is a policy which might with advantage be adopted in the case of some smaller structures which, due to their exceptional situation, may be almost equally important from an æsthetic point of view. Few engineers would deny the resulting advantages, and the main difficulty in making such an arrangement appears to be one of remuneration. The fees paid to the engineer for designing structures of this kind are generally insufficient to enable him to pay for architectural assistance. Where bridges of even moderate size are to be built in situations calling for exceptional æsthetic treatment there is a growing tendency for clients to authorise the engineer to obtain architectural advice in the preparation of the elevations, the client paying the architect directly. The cost of architectural advice is small compared with the total cost of the bridge and, considering that the structure is likely to remain in service for hundreds of years, this slight additional expenditure is justified.

The procedure in such cases has been first to discuss the scheme with the architect at the site, in order to obtain his general views on the composition of the design based on each of the several types which the engineering features of the site indicate as deserving consideration. These various types have then been investigated and one ultimately chosen as providing the best answer to the engineering problem. Keeping in mind the architect's advice on the general composition of the chosen type, the general scheme drawings showing the outline elevations, longitudinal sections and cross sections have been prepared in pencil. These have been submitted to the architect, with photographs of the site taken from several viewpoints and any additional notes which might be of assistance in treating the design architecturally. The engineer's drawings show the outlines of the proposed structure in their barest necessity; the function of the architect is to give the structure an appearance that has architectural merit at the lowest cost. The following suggestions may be helpful to architects engaged on bridge work for the first time.

**TYPE OF BRIDGE.**—The type of bridge shown on the engineer's drawings will have been chosen after careful investigation of the many different types which might be adopted, and will give the most economical construction to suit the site. In consequence the type of bridge should not be altered, although minor modifications are permissible if they can be made without seriously increasing the cost.

**SHAPE OF ARCH.**—The shape of a fixed arch is definitely settled by the span, rise, and loading for which the bridge is designed. In consequence it is not possible to alter its shape without increasing its cost. In a three-hinged arch adjustment of the shape within fairly wide limits is possible. In a fixed solid barrel arch the shape viewed from the side may be adjusted by introducing a thickening for a little way back from the face. Any thickening to the extrados is entirely masked by the spandrel walls. Thickening to the intrados will show as a projecting rib. The remainder of the arch barrel cannot be altered. If, however, slight adjustment of a few inches, say, would give the structure a much better appearance, the design may be amended to that extent. If it is desired slightly to increase the depth of the arch, this may probably be arranged also.

**COLUMNS AND BEAMS.**—As regards columns, beams, and other members, the cross-sectional areas are fixed and the proportions of depth to width are most

economical as shown on the drawings. Here again, however, slight adjustment may be made by the architect. For example, the proportions of a column 15 in. square in cross section may be adjusted to, say, 20 in. by 12 in., which gives approximately the same cross-sectional area and about the same strength without appreciable increase in cost. Twelve inches is, however, about the least figure to which the thickness of these members should be reduced. So far as the beams are concerned, a reduction in their depth may cause a disproportionate increase in cost, due to the increased reinforcement necessary to make beams of the decreased depth of equal strength to those shown on the drawings. In consequence it is desirable that the sections of the beams should be unaltered. In general, therefore, the dimensions given should be retained as closely as possible, but minor adjustments can be arranged.

SPAN OF ARCHES. —If the architect wishes to vary the length of the spans, for instance, to make the central span longer and decrease the spans toward the abut-

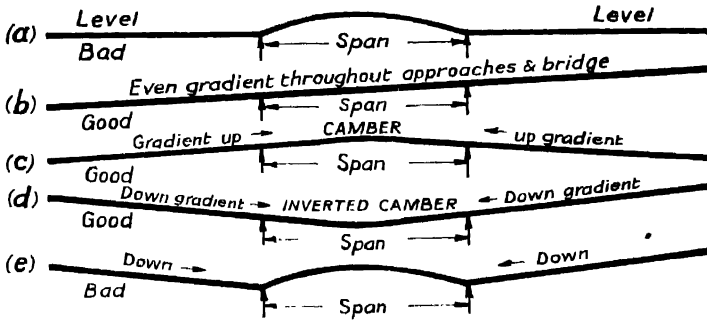

Fig. 200.

ments, this is possible, but it necessitates some increase in the cost of centering which must be set against the additional amount allowed for architectural treatment.

ROAD GRADIENTS.— Suggestions are sometimes made to alter the road gradients so as to produce a camber in the length of the bridge or even a slight hump-back appearance, but this is usually a matter for the surveyor or road engineer and is frequently one of the unalterable data. Primarily a bridge is erected for the facility and safety of road users, and the level of the bridge deck and the gradients of the approaches are fixed so as to obtain these ends with reasonable economy. Where both approaches are level [Fig. 200 (a)] it does not seem to be good road engineering to introduce a camber on the bridge. If both approaches are on an equal rising gradient (b), the bridge deck should be carried through on a similar gradient, for the convenience of traffic. If both approach gradients rise toward the bridge (c), a vertical curve may be used to give the camber over the bridge; this looks well from the road and on the side elevation. If both approach gradients fall towards the bridge (d), an inverted camber would provide the best contour from purely road engineering considerations; alternatively the bridge could be level, and joined to the gradients by vertical curves. In this case (e) a



camber does not look well from the roadway nor does it give a smooth run for traffic.

Whereas the side elevation of a bridge looks more graceful if cambered, a camber on a bridge with two level approaches is not pleasing when the bridge is viewed from the roadway. Whether or not a camber is provided, it should be as small as possible, so as to cause the least interference to the view of drivers.

**GENERAL ARCHITECTURAL TREATMENT.**—It is difficult to give a guide to the expenditure that is justified for æsthetic treatment in excess of the cost of the engineering structure. Different authorities have different opinions. The writers' view is that if a bridge is constructed in a country district of no special scenic beauty, one is not justified in spending on architectural treatment more than 5 to 10 per cent. over the cost of the engineering structure. If in a town, the cost of architectural treatment might in some cases be increased to 30 per cent. of the engineering structure cost without being considered wasteful. The cost of the architectural treatment of a memorial bridge might be considerably higher.

The increase in cost due to any additions or deviations made from the design



Fig. 201.

which provides the necessary strength and permanence, or any additions to it, must be put against the additional percentage mentioned. This additional cost is a factor in which the client will be particularly interested, and regarding which his instructions might well be obtained.

**ABUTMENTS.**—To a design for an abutment embracing the bare necessities of strength and permanence it would be reasonable to add a plinth. This addition would also be advantageous where the abutments are adjacent to a river and possibly liable to erosion, against which the additional thickness of plain concrete in the plinth would provide protection. The addition of a stringcourse or other simple feature would be fitting. If the abutments are finished flush with the outside line of the bridge, emphasis may be obtained at this point by a pier or pilaster on each side of the abutments which might form part of the approach wall behind the abutment. The pier should project as little as possible beyond the general side lines of the bridge, since a projection increases the lengths of the foundation trenches and foundations and may be costly.

**PIERS.**—The simplest form of cutwater to the intermediate piers of a river bridge is pointed, with straight sides to the splays; this is also the cheapest form of construction. Very little is involved in making cutwaters bullnosed (*Fig. 201*), or with curved sides, or to any other regular figure, because any shape can be

produced by using special boarding or plastered metal laths as shuttering for the cutwaters. Where there are several piers repeated uses of the shuttering are obtained. A cap for the top of the cutwater should be designed on simple lines, as its shuttering is likely to be complicated in any case, particularly in the case of a skew bridge.

Plinths added to the piers and projecting above the water line serve the same purpose as similar additions to the abutments.

**THE ARCH RING.**—Whereas the general shape of the arch ring cannot be altered, slight adjustments of say 2 in. or 3 in. either in thickness or shape can be made provided that the thickness shown on the engineer's drawing is not reduced. A stringcourse can be added to the arch ring, but it complicates the shuttering. Alternatively the arch may be grooved or nulls formed throughout the length of the ring to give the emphasis desired.

**COLUMNS SUPPORTING THE DECKING.**—As previously mentioned, the cross section of the columns may be altered from the most economical size and shape by widening them on the front elevation and making them a little thinner—with a minimum thickness of 12 in.—in the other direction. Their sectional area may, of course, be increased if necessary, but the additional cost of concrete and shuttering must then be considered as additional expenditure on architectural treatment. In the past all the columns over open spandrel arches have generally been made of the same cross section, although their heights may be 20 ft. or more near the abutments and as little as 3 ft. near the crown of the arch. If desired, the longer columns may be made a little larger, provided that every column along any quarter elevation of the bridge has not a different cross section since this prevents repeated use of the shuttering.

Instead of the column shafts springing directly from the sloping extrados of the arch, column bases can be arranged for in the construction. Actually a level bed formed on top of the arch ring and projecting above it from which the column can spring, is an advantage in construction. As it would be better construction to form the base at the same time as the arch is concreted, the shallower it is the more easily and efficiently it can be made.

From an engineering point of view there is no advantage in providing column caps except where long-span main beams are used across the deck. In such cases a projection of the main beams beyond the face of the columns, besides providing the basis of an architectural feature, permits better anchorage for the main beam reinforcement. These projections are also useful where provision is required to permit of cantilevering out for footpaths at a later date. In other cases column caps may be introduced, if they are of the same shape and size throughout the bridge, so that the shuttering may be carefully made and used repeatedly.

**LONGITUDINAL BEAMS.**—The outer longitudinal beams may be formed with curved soffits and circular splays instead of horizontal soffits and straight splays, the additional cost of the curved shuttering being small because it can be used repeatedly.

A stringcourse is usually made at the level of the deck slab, as the underside of the slab usually forms a construction joint in the depth of the side girders. It is therefore advantageous to extend the slab a few inches beyond the outside of the outer girders in order to mask the construction joint. Whether a string-

course or a cornice is introduced, its best position is with its underside level with the underside of the deck slab.

Subject to there being no undercut mouldings, there is very little difference

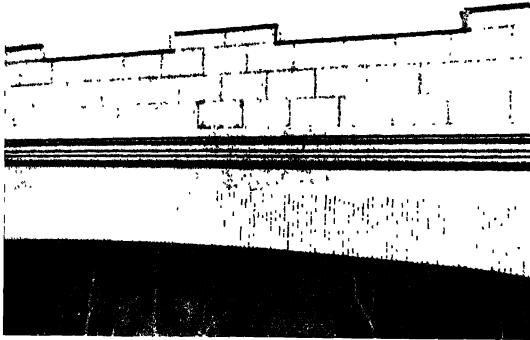

Fig. 202.

in cost in producing any shape of stringcourse or moulding desired. The moulding may be run in plaster on the shuttering and the concrete placed directly against the plaster. The moulding shown in *Fig. 202* was formed in this way.

**JOINTS IN THE OUTER GIRDERS.**—In a bridge formed of cantilevers alternating

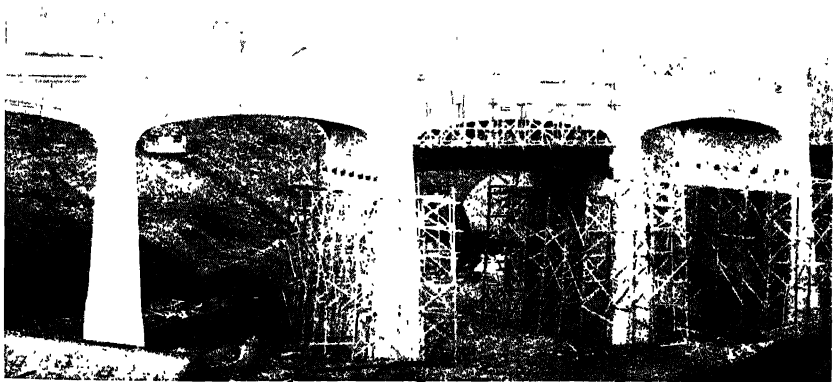

Fig. 203.

with freely-supported spans in which open joints occur at intervals, or where contraction joints are provided, attempts have been made in the past to fill these joints with various materials. This has not generally proved satisfactory, and in consequence the tendency now is to leave these essential joints open (*Fig. 203*).

Their positions can be altered a little in an arch, but any change in a cantilever bridge makes a less economical design. Unless a pilaster or pier is provided on the outside to mask the joint it is necessary to leave it exposed to form a part of the elevation. The joints are generally about 1 in. wide, and are not particularly obtrusive in the final construction.

**CONCEALMENT OF HINGES.**—In two- and three-hinged arch bridges a certain amount of "breathing" is concentrated at the joints. The central hinge may, if desired, be masked by moulding a keystone projecting from the general outside line of the arch, this being fixed to one side of the arch barrel and kept free on the other side. This, however, is a subterfuge. The alternative is to show the line of the joint as a plain black line about 1 in. wide on the outside of the structure. The joints at the abutments can be masked by a pilaster or pier as suggested for the fixed arch. One point to note particularly is that where a cornice returns around a pier which masks a contraction joint an absolutely free joint is necessary, otherwise a part of the cornice may be broken away by the small movements to which such joints are subjected.

**SPANDREL WALLS.**—Spandrel walls are generally retaining walls having the arch barrel as their base and retaining the earth filling above the arch. As there is always a construction joint along the line of the arch ring, emphasis of the arch ring, which will help to mask this construction joint, is an advantage. Spandrel walls are generally kept free from pilasters or piers constructed at the ends of the abutments, otherwise they tend to act as girders and are subjected to stresses for which they are not designed. A freely-sliding joint is therefore necessary between the ends of the spandrel walls and the abutments. To finish the surface of these walls any simple form of grooving, bush hammering, or similar treatment is suitable.

**PARAPETS.**—Generally, many more persons see the inside of the parapet of a road bridge than see the side elevation. In towns and in some rural situations the proportion may be considerably lower, but in every instance the inside of the parapet is really important and worthy of a higher proportion of any additional expenditure than the outside elevations. Although the cost of natural stone is generally at least double that of precast concrete, there may be some advantage in using it, and as the quantity is not large this may be the best way in which to spend a part of the money available for purely aesthetic treatment. It sometimes happens that features in a parapet look well on the exterior elevation but rather too heavy on the inside elevation of the parapet. To prevent this a detail should be prepared showing the inside of the bridge parapet from the roadway, in addition to the elevations of the outside of the bridge.

Precast concrete blocks of any size up to about 6 ft. long and the full height of the parapet are practicable, and can be moulded to exhibit practically any simple and regular decorative feature.

The coping may be moulded to any desired shape. As a large number of blocks will be required from the same moulds, the cost of the moulds, no matter how intricate they may be, has no great bearing on the cost of the finished work. As the units are comparatively small it is easy to produce a better finish on them than on in-situ work.

A precast parapet (*Figs. 202 and 204*) is preferable to in-situ work because it is somewhat difficult to obtain absolutely true lines in in-situ work. Even

slight irregularities in line are very evident when the parapets are viewed in the direction of their length.

Parapet piers are generally precast from one set of moulds, but if large architectural features are introduced that cannot reasonably be transported and

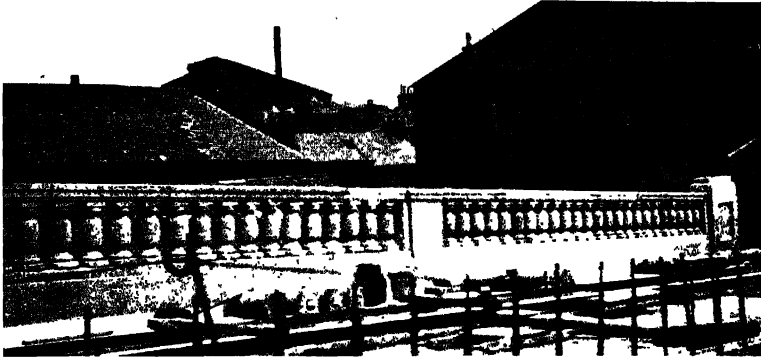

Fig. 204.

placed in one piece they may be cast in position, even if the mouldings are complicated, provided arrangements are made so that the shuttering is easily stripped. The in-situ work may not have quite such a good surface finish as the precast work.



Fig. 205.

An open balustrade instead of a solid parapet is very well fitted to precast concrete construction (*Fig. 204*). Whereas balusters of natural stone are somewhat expensive, they are little if any more expensive than ordinary rectangular blocks if cast in concrete. The moulds can be made in plaster, timber, or in concrete moulded from turned timber or plaster patterns. If it is decided to use a balustrade, three or four balusters should be made in wood or plaster and erected

(Fig. 205) for preliminary inspection so that any minor adjustments can be made. They are then used as patterns for the final balusters.

**FIXING BALUSTERS AND PRECAST COPINGS.**—Either copper dowels or dowels cast on the various members can be used for fixing balusters and copings. For balusters a good fixing is obtained by forming 3-in. by 3-in. by 1½-in. deep recesses in the plinths and the underside of the copings and similar projections on the ends of the balusters. This gives a very rigid connection. For coping stones it is better to leave holes in the ends and set copper dowels into these. The dowels may be either of tube or solid copper having a length of, say, 6 in. and a diameter of  $\frac{3}{4}$  in.

**MEMORIAL TABLETS.**—If it is decided to place a memorial tablet on the bridge, a definite position should be assigned to it on one of the piers so that it does not appear to be an afterthought. Its size should be suited to the scale of the bridge. Although the tablet can be cast in concrete this does not show up well; a bronze memorial tablet fixed to the concrete by lugged bolts is to be preferred.

**JUNCTIONS OF PARAPET AND APPROACH WALLS.**—Where post-and-wire fences are used, a better appearance seems to be obtained by having an end post butting on to the end of the parapet wall even though this end post may need to be specially made. Sometimes the wires are fixed into the ends of the parapet walls by eye-bolts, but these do not look very well and, in addition, are liable to deteriorate much more quickly than the bridge structure. If they need to be replaced at a later date the cutting out and replacement may damage the ends of the parapets. Where walls are introduced along the approaches the parapets and walls should be designed so that the two will join in a pleasing way.

**TREATMENT OF PARAPET GIRDERS.**—From the point of view of appearance a parapet girder is somewhat clumsy and is rather difficult to finish in an attractive way. It has also the disadvantage that it places cast in-situ work—of which the lines are not nearly so true as in precast work—in a position where it can be seen along its length. For this reason it is an advantage even in a parapet girder to introduce a precast coping. Further to improve their appearance features may be moulded on them, but nothing may be deducted from the engineering design.

Parapet girders should be used as seldom as possible although in some situations they are economical. One reason is their bad appearance and another that if a runaway vehicle were to crash into a parapet girder it might endanger the safety of the whole bridge.

**LAMP STANDARDS.**—If concrete lamp standards are used they may be either precast or cast in position. Any shape may be chosen, as the shuttering is used repeatedly and one set of shuttering will probably be sufficient for the whole of the standards.

**COLOURED CEMENT.**—A more pleasing tone is obtained from a coloured cement than from natural cement colour, but in work cast in position it is very difficult with local materials to obtain an absolutely uniform sand and mixture throughout, and variations in the colouring result. These generally show up as a kind of "cloud effect" which is not pleasing.

In precast work, however, which consists of comparatively small units, it is quite easy to obtain uniform colour throughout any unit or series of units.

A slight difference in shade between complete units made at different times is not objectionable, in fact, it is often attractive. For this reason, too, there is no objection to the use of coloured stringcourses where only comparatively small quantities of concrete are required at a time and it would not be difficult to obtain an exactly similar shade throughout. A coloured stringcourse may be introduced in another way by forming a recess in the face of the concrete by planting a board on the inside of the shuttering and then, at a later date, filling the recess with coloured cement mortar. This is a permanent and effective method. Buff and red cements are inexpensive—some others are rather costly.

ORNAMENTATION.—Any ornamentation which can be repeated many times in the course of the work by using the same mould is suitable, no matter how complicated it may be, for it is practically as easy to place concrete in a decorative mould as it is to place concrete against ordinary shuttering. The additional cost, therefore, is only the original cost of the shuttering, which if used frequently is not very costly for each unit.

SURFACE FINISHES.—Several different surface finishes are available. In order of simplicity and probably of cost these are:

(a) *Rubbed Finish*.—This is produced by rubbing the surface of the concrete with carborundum blocks and water after stripping the shuttering. It is inadvisable to add cement. Should there be any imperfections in the surface, such as honeycombing or pin holes so bad as to require filling, these should be filled before the rubbing process commences and the filling should be permitted to harden thoroughly. The carborundum block is used over the whole surface whether this is irregular or not, and on completion the face dries out to an even creamy white colour.

(b) *Exposed Aggregate Finish*.—This is obtained by painting on the shutters a chemical which prevents the cement immediately adjacent to the shuttering from setting. When the shutters are stripped the surface of the concrete is brushed with a wire brush which removes the outer skin of cement and leaves particles of the aggregate exposed. The difficulty with this method is that up to the present no really satisfactory chemical has been found which will retard the setting of the outer skin for a period of three weeks. Unfortunately in bridge construction it is frequently necessary to leave the shuttering in position for a period so long as this, and, in consequence, this method of producing exposed aggregate is not generally suitable for bridge work.

(c) *Bush Hammered Finish*.—After the shuttering has been stripped and the concrete surface has thoroughly hardened it may be bush hammered. Over large areas this is carried out by means of a hammer driven by electricity or compressed air, a light tool being used and the shape of the teeth depending on the depth of cut required. For small areas a similar effect may be produced by a special hand axe having five or six blades clamped together, the surface of the concrete being lightly hit by the edges of the blades. The depth of cut may be whatever is required, from a slight roughening of the surface to a cut about  $\frac{1}{2}$  in. deep. The resulting finish is good in appearance, its quality and colour depending on the materials used in the concrete. If granite aggregate is used the finished work has more or less the appearance of scabbled granite. If whinstone is used the finished surface has a bluey-grey appearance which is

not so attractive. If gravel is used the surface has a brown tone when viewed from a short distance. Bush hammering removes the outer skin of cement mortar which offers a very excellent resistance to all deteriorating influences ; it is desirable to increase the cover of concrete that is to be bush hammered. If it is decided to use bush hammers a block of concrete made of the materials proposed for use in the work should be hammered to different depths so that the hammer best suited to the work may be selected.

(d) *Grinding*.—A further surface treatment is to strip the shutters, permit the concrete face to harden and dry out, and grind it with a revolving carborundum disk. The effect produced is somewhat similar to a second quality terrazzo, the appearance and colouring depending on the aggregates used. This treatment costs approximately twice as much as bush hammering. It is not, however, open to the objections of bush hammering, as the finished semi-polished coat is almost if not quite as weather resisting as the original concrete face.

(e) *Moulded Fluting*.—This can be produced in the surface of the concrete by lining the shutters with a suitable grooved material. Such grooving (*Fig. 202*) gives some " life " to the concrete surface and provides a considerable improvement on the somewhat dead appearance of ordinary concrete. Coarse canvas has been fixed to the face of shuttering to produce a somewhat similar effect, but the difficulty with this is that it sometimes proves rather difficult to strip. One of the points to guard against in connection with any lining is bulging after it becomes moistened by the concrete. If this occurs, irregular grooves show in the finished concrete surface. On one occasion the writer lined the soffit of an arch with mill board in order to produce a smooth surface. Despite the fact that there was approximately 15 m. of solid concrete laid on the top of this mill board, the weight of which was expected to keep the mill board down, it expanded and formed corrugations, each about 2 in. wide and 1 in. deep, in the under surface of the arch at intervals. Bitumen sheeting may be used to give a smooth surface free from board marks, but in order to get the sheeting to strip satisfactorily it is necessary to whitewash it before the concrete is placed on it. Special shutter-lining board is available for obtaining smooth surfaces, and due to its rigidity there is no danger of it curling. Such lining must be tough and durable to withstand wear and weather during the assembly of the reinforcement and until concreting is completed.

(f) *Rendering*.—Finished concrete surfaces may be rendered and almost any texture may be given to this finish by using steel floats, wooden floats, combs, or brushes. An objection to a rendered coat is that whilst it looks well when first finished it often crazes in time and after a period of years tends to break away.

(g) *Painting*.—Any smooth surface may be painted after the concrete has matured. Several special paints are made for this purpose, the best probably being one which has as its base some oil which has an affinity for concrete. These paints are made in a variety of colours. Whilst painting may produce initially a slightly glossy surface, after about twelve months the gloss weathers off and leaves a matt surface. The best types of paints penetrate a little into the face of the concrete, and their effect lasts for several years. With most of these paints it is better to defer painting for twelve months after concreting when most of the chemical action in the concrete has ceased. It is best to use cement paints specially made for the purpose.



(h) *Shutter-Board Marks*.—The shuttering may be lined with special boarding, plywood, or sheet metal in large sheets to avoid the marks of the shutter boards which otherwise are always to some degree evident in the finished work.

Another method is to line the shuttering with weather-boarding or even to use very thick weather-boarding as shuttering. By this means a ridged effect (Fig. 206) is produced on the finished face, and if the shuttering is designed to produce these small ridges to a predetermined design the effect is pleasing. The most satisfactory practical treatment is to have the ridges at from 4-in. to 7-in. centres and a projection of about  $\frac{1}{4}$  in. to  $\frac{3}{8}$  in. It is better to use boarding having the edges shot off lightly in order to avoid the risk of breaking them away during



Fig. 206.

concreting or of breaking away the concrete arrises during stripping of the shuttering. With this boarding only blunt ramming tools should be used in the concrete work so as to avoid damaging the boarding, and, in addition, it is necessary to take a little more than the usual care in ramming the concrete and in stripping the shuttering.

(i) *Natural Stone Facing*.—Stone facing is rather expensive and, although it improves the appearance, does no useful work in the finished structure. In consequence it is much more economical to form a satisfactory surface in some other way. If it is considered imperative to use stone, due, for example, to close proximity to a stone building, the facing may be anything from 4 m. upwards in thickness depending on the type of stone proposed. The best result is obtained by building the stone face and placing the concrete behind it, the lifts being of such a height that they will not cause the facing to bulge. This produces a more rigid construction than if the concrete is built first and the facing placed in front of it, the joints between being flushed up with mortar. It is advisable to provide ties in the joints of the masonry facing; these may be of copper, say, 12 in. long by 2 in. by  $\frac{1}{4}$  in. and having fish-tail ends. If facing is used the mortar joints must be allowed to set thoroughly before placing the concrete behind, otherwise there is a tendency for the grout from the concrete to run through the joints and down the face of the masonry, so discolouring it.

The previous paragraphs cover most of the questions which are discussed by the engineer and the architects who are advising on the elevations of bridge work. Many more detail points arise later, but in general these are peculiar to a particular bridge under consideration.

It may be noted that economy is frequently stressed throughout the foregoing. To what extent it should govern the ultimate treatment calls for consideration of each case by itself. Whereas the ultimate decision concerning the permissible expenditure on æsthetic treatment rests with the client, a reasonable expenditure may well be approximately agreed by the engineer and architect early in the development of the scheme and submitted to the client for approval.

## CHAPTER X

### STRENGTHENING, WIDENING AND RE-ALIGNMENT OF EXISTING BRIDGES

MANY old bridges exist which are in fairly good condition structurally, but which, due to development in the type and amount of traffic, are not suited to present-day requirements. Among structures of this kind there are many which may, by some alteration, be made suited to present needs, and it is the purpose of this chapter to describe generally the treatment of cases of this kind.

Old bridges in good structural condition may require alteration for one or more of the following reasons :

- (1) Because there are old square crossings with bad corners at one or both approaches, a case typical of many ancient bridges ;
- (2) Because the bridge is too narrow for present-day requirements, probably suited to one-way traffic, whilst a sufficient width for two-way traffic and foot-paths is now necessary ;
- (3) Owing to the presence of a humpback in the centre ; in order to improve the bridge the hump must be eliminated ;
- (4) Because secondary roads have become primary roads, and, in consequence, the amount and weight of traffic have greatly increased ; and
- (5) Because some parts of the old structure have shown signs of either distress or decay.

If an existing bridge is in fairly good condition and, up to the time when improvement is given consideration, is dealing with all the traffic along the road of which it forms a part, there is naturally some reluctance to abandon it entirely, even if its factor of safety under modern conditions is very low. In such cases the first consideration is whether it is possible in any way to make use of the old bridge in the scheme of improvement. It is a problem which calls for special investigation, including comparison of the cost of making the necessary alterations or strengthening compared with the cost of pulling down the old bridge and building an entirely new structure.

In comparing a proposal for alteration with one of entire rebuilding, there are certain advantages and certain disadvantages which must be taken into account in addition to the consideration of cost. In the first place the total cost of widening, strengthening, or alteration is generally less than that of a new bridge, but at the same time the cost per square yard of the actual widening is usually higher. Not only does the saving occur in the bridge proper, but also there is frequently a saving in the approach work. In addition, where a widening is made it is usually possible to keep the existing roadway open throughout the whole of the operation without serious disturbance to traffic.

Against these advantages, there is often reluctance to repair or widen a comparatively old structure when this requires much expenditure, since it is evident that at some time in the future the new work will still remain capable of doing its duty whilst the old portion will probably have deteriorated to such a degree as to call for complete renewal. A second disadvantage is that after the alteration has been made the finished line of the roadway is seldom the best to suit modern requirements, nor, as a general rule, are the grade and contour of the road so good as would be provided in an entirely new scheme. A third point is that one is seldom able to assess accurately the strength and internal condition of the old structure, and so, even when the work is complete, whilst one is sure of the carrying capacity of the new portion, there remains an uncertainty about the strength of the old work. Finally there is the difficulty of providing a satisfactory appearance to a bridge strengthening, widening, or re-alignment without expending on the new work an appreciable sum of money on this account alone, over and above that necessary to provide increased strength and width. Whilst reinforced concrete usually provides the structural work in a widening or strengthening, seldom in such work is one able satisfactorily to leave the concrete showing on the elevation. Instead, one is almost compelled to face the concrete with a comparatively expensive veneer of a stone similar to that of which the original structure was built and which will still be left exposed in the old part of the work. This is an expense which gives no direct return since such a veneer does not assist in carrying the increased load.

The preliminary investigation for a work of this kind is exactly similar to that for a new construction, but, in addition, it is necessary to make a thorough investigation of the construction, condition, and strength of the existing work. If drawings are obtainable showing the construction of the existing bridge these should be examined and compared with the work so far as possible to verify that in the original structure no appreciable deviation was made from them. If any variation is found then it may be necessary to make an investigation under the roadway of the existing bridge to verify that the thicknesses of spandrel walls, arch rings, etc., are in accordance with the drawings. If drawings are not available it is necessary to measure the existing work in order that drawings may be prepared to form a basis of theoretical investigation of the strength of the bridge. A careful examination must also be made of the condition of the work. The stone should be examined to verify that it has not appreciably deteriorated as a result of atmospheric or other influences. This is particularly important in the case of stone bridges in industrial areas where the atmosphere frequently contains gases detrimental to the stone work. An examination should also be made to make sure that the stone has been laid on its natural bed and that there is no undue deterioration as a result of neglect of this requirement. Cracks in the construction should also be looked for both where they appear as the opening out of joints and particularly where fractures show through the stone. The former may not be particularly serious, but where cracks follow partly along joints and at other places pass right through the stones of the structure they are more serious and it is difficult to make the work entirely good. Such cracks indicate greater disruptive forces at work than would cracks along the joints alone. Careful examination should be made to ascertain whether there is any sagging of the arch or arches; this should not be confined to the two elevations of the bridge but attention

should be paid to the central portion also, for sometimes, due to the greater load which is generally brought on to the centre of the roadway, a portion of the arch in this area may sag whilst leaving the outer faces practically on the original lines. A defect of this kind usually shows by a projection of central arch stones at the underside of the joints. Sagging of arches usually shows in one of two ways, either by a settlement at the crown or by movement at the haunches. The condition of the spandrel walls should be examined, particular care being taken to verify that they still remain on their original lines and that they are still plumb. Frequently the spandrel walls of old bridges were constructed of a section inadequate to withstand the pressure of the earth retained, and one will often find that a certain amount of bulging of these spandrels has taken place. The piers and abutments of the bridge should also be plumbed in both directions to ascertain whether any movement has taken place. As regards the foundations, investigation should be made of the kind of ground on which they rest and, if they are adjacent to a stream, careful examination should be made to ascertain whether there has been any scour tending to undermine them. Cases have been known where bridges have continued in use and have given satisfaction until an exceptional flood has occurred which has produced a defect in the structure, examination of which has disclosed considerable scour of long standing. General appearance of the work should not therefore be accepted when considering this point, but probings and any other method suited to the particular case which will give definite information should be adopted.

Finally, note should be made of any repairs which have been made to the old structure since its construction. Evidence of this can be seen in stones evidently newer than the original work; tie rods between spandrel walls; additional ribs constructed under the original arches; and in fact in every detail which would appear foreign to an entirely new structure. Repairs of this kind indicate that the structure as originally built was not particularly strong, and the tendency would be to lead one to build a new structure rather than to recondition an old one which had evidently, even in the past, proved unsuitable for its work.

Whilst this examination is being made notes may be collected to indicate what repairs will be necessary to the existing work in the event of a widening or strengthening scheme being adopted. Such repairs might consist of replacing the defective stones, pointing the existing structure, and possibly waterproofing the extrados of the arch to prevent percolation of water through the joints. Percolation of water through the joints of stonework occasionally causes trouble which may ultimately result in the settling of an arch ring due to the deterioration and washing out of the mortar between the stones.

Cases of bridge widening and strengthening may be divided into two types: (a) those in which the existing substructure will be adequate under the new conditions, and (b) those in which the existing substructure is inadequate.

Where the existing piers or abutments are adequate any widening of the bridge should be arranged so that there is an equal increase in width on both sides. Not only does this facilitate the arrangement of the superstructure of the new work, but it also has the advantage of spreading uniformly the additional load brought on to the foundations. In cases of this kind there are two general types.

First there is the case where the existing abutments and piers project an appreciable distance beyond the faces of the old bridge superstructure. A case

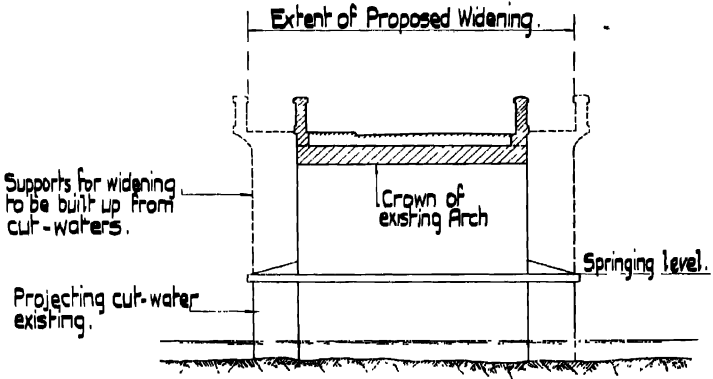

Fig. 207.—Method of Widening where existing Piers project.

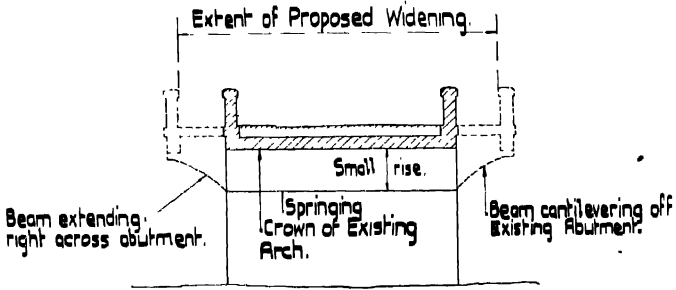

Fig. 208.—Widening by Double Cantilever resting directly on existing Pier.

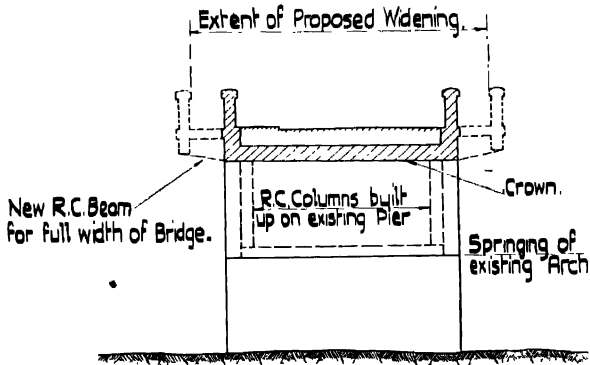
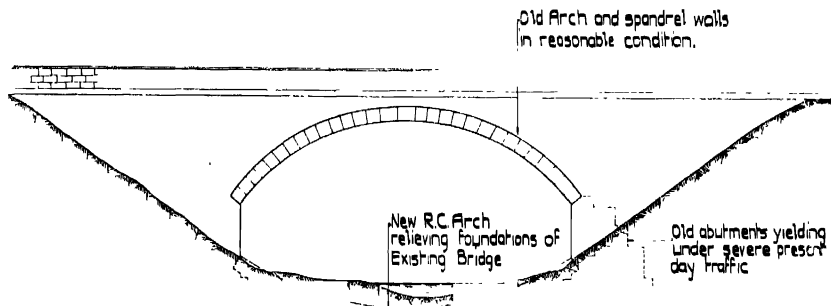

Fig. 209.—Widening by Double Cantilever on Columns built up from existing Piers.

typical of this occurs in bridges spanning rivers, where the cutwaters of the piers of the existing bridge project a considerable distance beyond the faces of the parapets and spandrel walls (*Fig. 207*). Where these projections exist it is often possible to build up from them, so increasing the width of substructure available at the springing level of the superstructure. In cases where the existing foundations do not project beyond the width of the roadway, it becomes necessary to provide some support for the widening projecting from the existing piers or abutments. This can best be done by cantilevering across the piers and abutments, giving an equal length of cantilever on both sides of the bridge. Such cantilevers must, of course, have their foundations carried down to the top of the original pier or abutment; this is usually at the springing level of the existing arch and considerable depth of excavation through the filling over the old bridge is required. The cantilever itself can be constructed at this level (*Fig. 208*), or, alternatively, piers or columns may be built up from the old springing level and the cantilever



**Fig. 210.**—Strengthening Foundations of Old Bridge.

beams formed at approximately the new road level (*Fig. 209*). Whichever method is adopted it will call for ingenuity on the part of the engineer to arrange the new construction in such a way that it will still permit of the existing roadway being kept in service throughout the carrying out of the work.

The case where the existing foundation is inadequate is also divided into two subdivisions. In the one case there are examples in which the inadequacy is due either to deterioration of the subfoundation or to scour. Where the deterioration results from the decay of piling it is likely to prove an extremely expensive and tedious operation to make such foundations good and will considerably favour the adoption of an entirely new structure. In such cases it may be found necessary to surround the existing foundations with sheet piling of either concrete or steel and to apply pressure grout to the area so enclosed. Both these operations are very expensive and, in preparing estimates for the widening, a very ample allowance for contingencies should be made over and above a fair estimate of the cost since pockets may be found during the operations requiring large amounts of cement to consolidate them. It should be noted also that the vibration due to the driving of piles adjacent to an old structure may in itself involve such a risk of trouble with the existing work as to make it impracticable.

In some cases where the distance between the pier supports is not great and where they have shown signs of distress a method of strengthening consisting of inverted arches laid in the river bed between the piers or abutments may be worthy of consideration (*Fig. 210*). It is impracticable to describe every method of dealing with a contingency of this kind and a separate method must be devised to suit each case met in practice. Generally, however, such cases may be dealt with by the use of sheet piling, cementation, or filling with plain concrete.

The second problem arises where the existing foundations are inadequate and it is necessary to increase their area. In such a case it is far better to arrange for the widening to be carried out on one side of the bridge, thus reducing to one operation the widening of each pier or abutment instead of making two operations in each case as would be necessary if the bridge were widened on both sides. Where this arrangement is adopted it is usually possible to make an improvement in the alignment of the roadway.

Where foundations require to be increased the first necessity is that a method shall be adopted which will ensure no relative movement between the new and old work. If any such movement takes place then internal stress may develop between the new and old work with consequent trouble to one or both. Probably the bad effects would show in the existing structure as a result of the drag due to bedding down of the new work on its subfoundation. To avoid this it is usually desirable that the new foundations should be carried down to the same depth as the original work and, in fact, that they should be even a little more consolidated. For example, if the original foundation was on piles then the new foundation should be either slightly more substantial or have a slightly greater number of piles per unit area than the original work, to make quite sure that the rigidity of the new foundations will be at least equal to that of the old work allowing for any consolidation since it was built. To this end, also, it is usually desirable to adopt the same type of foundation as in the original work. In case of rock it is evident that there will be no relative movement between the new work and the old, but on other subfoundations special precautions will be required. For example, if the original work was founded on clay it may reasonably be assumed that some consolidation has taken place in the clay, and if the new work is placed directly on it without previous preparation it is likely there will be a certain bedding down with consequent danger of some drag on the existing structure. To avoid this the subfoundation should be solidified, either by driving stakes into the clay or by boring comparatively shallow holes and grouting up below the general level of the foundations. In such cases the greatest care should also be taken when excavating to strip off the last four to twelve inches of ground and to seal it immediately with concrete to avoid a layer of puddled and loose ground forming immediately under the new foundation. Neglect of this precaution will certainly result in an increase of the bedding down of the new structure. Gravel and sand subfoundations are much more easily dealt with. Where these are found in compact beds they can usually be built on without any special preparation, although in a case such as this it is inexpensive and advisable to grout the bed for a little depth below the foundation. This can easily be done by working down a crow-bar or a tube and filling the holes so formed with grout as the bar or tube is withdrawn. This primitive method of applying cementation to the ground below gives excellent results in many cases. Where piling is being considered in the widening of an



existing structure, care should be taken to arrange the work in such a way that no damage will be done to the existing bridge. Whenever piles are driven in the normal way considerable vibration develops in the ground, and this may prove dangerous to an old structure, particularly if the final driving is severe. An alternative method in a case such as this is to bore in the ground, a process which does not cause any appreciable vibration, and to fill the bore holes with either concrete or reinforced concrete so forming in-situ piles. In every case when the concrete foundation is laid care should be taken thoroughly to ram it into the virgin ground below in order to consolidate it as much as possible as it is laid.

Finally it will usually be found more simple to widen a bridge over a stream on the upstream side rather than on the downstream side so far as the foundation work is concerned. The reason is that a considerable tendency to scour usually exists on the downstream side of a bridge, and, in consequence, in a widening of this kind one is likely to be working in deeper water than if the work were carried out on the upstream side. At the same time, from considerations of permanency, if the scour on the downstream side is reaching proportions where it may perhaps call for protective measures, then these can be incorporated with the widening by carrying out the new portion of the work on the downstream side and to a greater depth than the original piers. Each case requires to be decided on its own merits, but this point should be given consideration in dealing with such schemes.

### Strengthening of Superstructure.

There are four main ways of strengthening the superstructure of a bridge.

(1) By means of a relieving slab constructed at a level immediately beneath the road surface with a view to causing appreciable spread of any live load which the bridge may be called on to carry before this load strikes the extrados of the arch (*Fig. 211*).

(2) By carrying up piers or supports from the tops of the abutments and building across these a beam or slab construction which will entirely relieve the existing arch of any load except that due to its own weight and the filling over it (*Fig. 212*);

(3) By thickening the existing arch, using a reinforced concrete construction and tying this by means of metal ties to the extrados of the arch (*Fig. 213*); and

(4) By a cellular construction of reinforced concrete directly over the existing arch and replacing the existing earth filling (*Fig. 214*).

The first method, using a relieving slab, is open to considerable criticism, and should not generally be used except in unimportant bridges where the existing structure still appears reasonably capable of carrying the load. It is quite impracticable to make any accurate calculation of the effect of such a relieving slab, but it is obvious that such a slab, spreading concentrated loads as it must necessarily do, will appreciably reduce the concentration of stress in the superstructure and, what is perhaps more important, reduce the effect of vibration on the old work.

The second method of carrying up the abutments and spanning an entirely new structure across, thus leaving the existing work to carry only its own weight, is a perfectly sound method. Its adoption depends on the span and, as a general rule, such a method cannot be successfully adopted where the clear span of the existing bridge exceeds 60 ft.; it is not generally economically practicable where

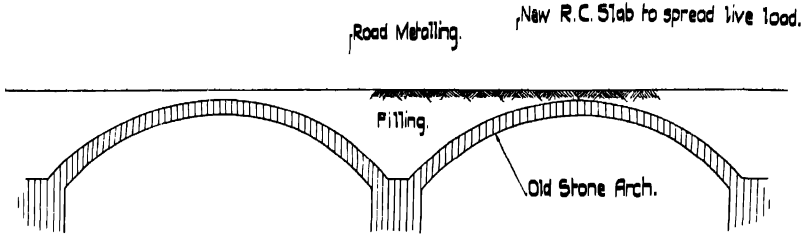

Fig. 211.—New Reinforced Concrete Slab spreading Live Loads and so relieving Old Arches.

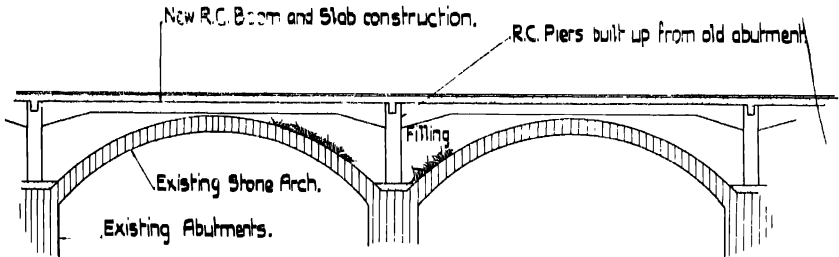

Fig. 212.—Relieving Old Arches from all Live Loads by New Reinforced Concrete Superstructure.

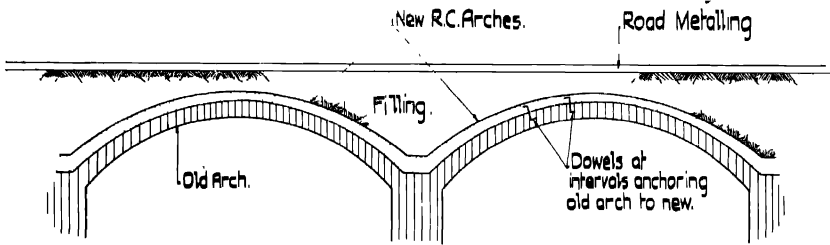

Fig. 213.—Relieving Old Arches from all Loads by New Reinforced Concrete Arches.

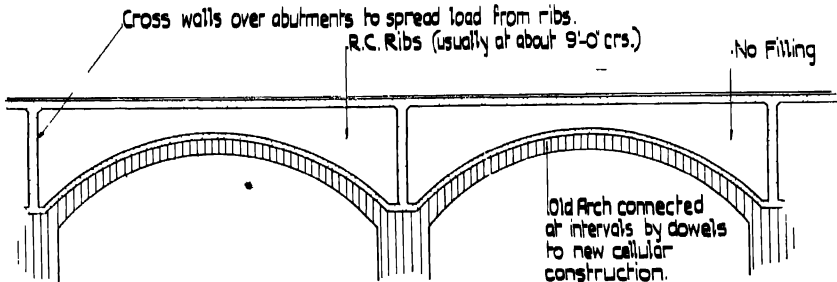

Fig. 214.—Relieving Old Arches from all Loads by New Reinforced Concrete Cellular Construction.

the span exceeds 30 ft. The construction in a case of this kind should be designed as a portal frame, as outlined in Chapter V. This construction, also, is suited to the elimination of a humpback from an existing bridge.

The third method of thickening the arch really necessitates the design of the new arch ring of sufficient strength to take the whole load, leaving the existing ring to carry only its own weight. Calculation on any other assumption is impracticable, as the existing and new arch rings are of entirely different materials and will probably act independently. One difficulty in this method is to provide a suitable skewback and abutment from which the new arch can spring, for it will usually be found that the existing abutments are no more than adequate to resist the thrust from the existing arch. The new arch thickening will, of course, spring from a point behind the existing arch and from a far less favourable position on the existing abutment. This method will, therefore, usually be found more suitable in cases where the arch springs directly from a rock subfoundation.

The fourth method, that of cellular construction, has many advantages. In the first place it permits of the entire removal of filling from the top of the existing arch and so considerably reducing the dead load. In the second place such a cellular construction can invariably be arranged so that it will carry the whole of the loading of the finished work, and, in addition, it can be tied to the existing arch ring so that if at any time this tends to collapse it will be supported directly by the new construction above. The method usually involves the stripping of the filling, the introduction of metal ties in the extrados of the existing arch, and the construction of a comparatively thin slab of reinforced concrete over the existing arch from which ribs project up to deck level, where the ribs are again joined by a reinforced concrete slab of sufficient strength to span between the ribs and to carry the roadway and all live loads. The ribs, in consequence, have very considerable depth at the springings over abutments and piers, and are comparatively shallow over the crown of the arch, and should therefore in general be designed as continuous beams having varying moments of inertia. The reduction in weight resulting from this form of construction is a desirable feature and may in some cases avoid increasing the foundations with consequent considerable economy. If, on the other hand, a certain amount of filling is considered desirable, arrangements can be made to fill any particular part of the cellular construction and leave the remainder empty. The one difficulty which arises from this method is to preserve the roadway across the existing bridge during the carrying out of the work, since it is necessary to excavate the whole of the filling over the existing arch. This, however, can be overcome by the construction of one complete longitudinal cell before proceeding with the remainder, or in other ways.

One of the points which calls for consideration in the work of widening an existing structure is whether or not the widening should be tied to the existing work. In general it may be said that for short spans up to a maximum of about 50 ft., and in cases where the existing arch is of comparatively large rise, and provided also the foundations will remain rigid, the new work may be tied to the old. In all other cases where there is probability of some slight movement between the new and the old work a sliding joint should be provided. The advantage of tying the two together is that the new work will tend to strengthen the old structure along what is probably its weakest part in the widened work. The comparatively weak edge of the old work usually becomes in the new

construction the centre of the roadway and will be called on to carry the maximum loads. The tying may be carried out in one of two ways : either by cutting holes in the face of the existing work and grouting in steel ties, the projecting portion of which will then be embedded in the new construction ; or, alternatively, by simply hacking off the face of the existing work to provide a rough and clean surface against which the new concrete would be directly laid. Whilst this may at first sight not appear to be a very rigid tie, on consideration it will be appreciated that a joint of this kind has a high resistance to shear.

In cases where the span exceeds about 50 ft. a sliding joint between the old and the new work should be provided. In such cases there is more probability of settlement of the new construction, due to stripping of the superstructure centering, to contraction, or to bedding down of the new foundation. Where a sliding joint is to be provided care should be taken to ensure that it actually

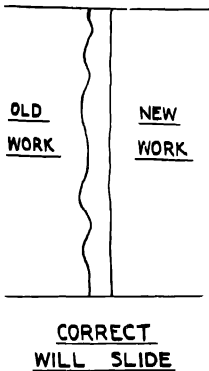

Fig. 215.

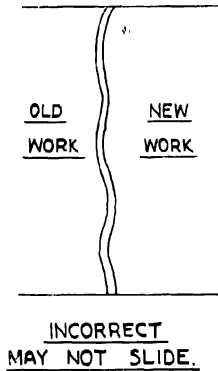

Fig. 216.

will slide. In other words, the filling in the joint should be sufficiently thick to permit shearing taking place in the filling material itself, for if there are irregularities in the face of the existing work deeper than the thickness of the filling material and into which the new concrete can bed some interaction is likely to take place (*Figs. 215 and 216*).

Care should always be taken to ensure that there will be no leakage of surface water through the joints between the old and new work. Where adequate precautions are not taken this joint is liable to be a constant wet spot with consequent deterioration of the work around this area. This is particularly undesirable in view of the fact that this joint usually becomes the centre of the new roadway and in such a position is liable to the maximum effect of traffic and vibration.

Wherever the foundations are widened the new construction should be made entirely self-supporting so that, if at any future date the older bridge deteriorates to such a degree that it requires renewal, it may be possible to demolish this and rebuild it without affecting the new work.

In connection with such widening it will often be found that a considerable improvement of the roadway can be effected by re-aligning the parapets at the ends of the bridge on the opposite side from the widening. This can often be



carried out by spanning a beam across from the existing bridge to the face of the wing wall or to an independent foundation, as shown on *Fig. 217* and the accompanying photograph (*Fig. 218*). Whilst the distance the parapet is set back is not great, it often has a very considerable effect on the alignment of the new roadway.

In works of widening care must be taken not to interfere with the drainage of the filling to the existing bridge. Sometimes this is by means of weep holes

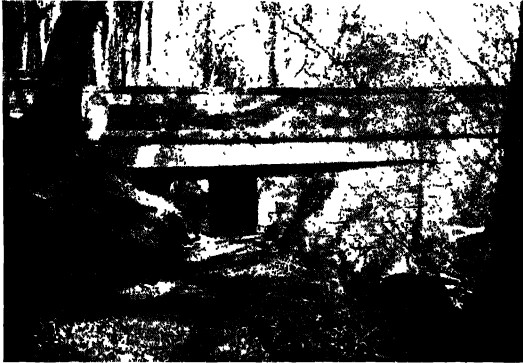

**Fig. 218.**—Re-alignment of Parapet in *Fig. 217*.

through the spandrel walls, and, if these exist, drains should be carried from them directly down through the new arch ring. Alternatively, they may be collected together in one drain and carried over the new portion and discharged at convenient places at both ends of the bridge.

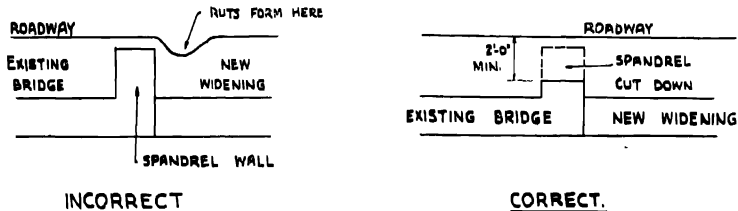

**Fig. 219.**—Junction of widening and existing Bridge showing how Spandrel Walls should be cut down to avoid hard spot in Roadway and subsequent formation of Ruts.

The filling placed over a new widening must be particularly well solidified, and to this end the materials for filling should be well chosen. It is advisable to use a special ramming tool as, for example, a petrol-driven rammer in order to ensure complete solidification and to avoid ruts forming at the junction of the old and new work in the finished roadway. To this end also care should be taken to cut down the spandrel of the old bridge adjacent to the new widening to a level at least 2 ft. below the finished roadway; if this is not done the line of the old

spandrel wall will form a hard spot in the centre of the road, and in a very short time deep ruts are likely to form on one or both sides of it. The filling over the demolished spandrel wall should be made to match as far as possible the density of the filling on both the new and old work (see *Fig. 219*).

A widening scheme should usually include for the re-pointing and re-conditioning of the existing structure. It is advisable, in addition, to include for the removal of any trees within 15 ft. to 20 ft. of the face of the existing work to give an air space and to prevent deterioration due to continuous moisture.



BEFORE WIDENING

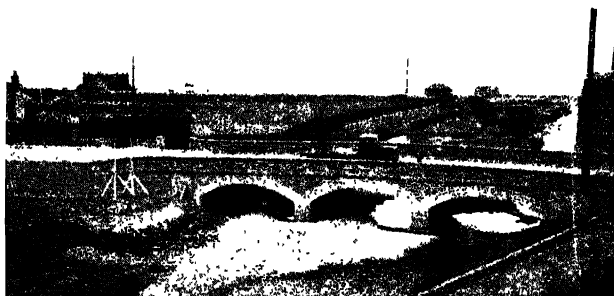

AFTER WIDENING.

**Fig. 220.** -Cowie Bridge, Stonehaven.

[NOTE HOW CLOSELY THE NEW WORK FOLLOWS THE OLD STRUCTURE IN APPEARANCE.]

These notes outline the general principles to adopt in considering schemes of this kind and indicate that every scheme will provide its own particular problems, the whole of which can hardly be covered in any general analysis.

Finally, there is the question of the treatment to be adopted for the elevation of a widened structure. In the case where it is decided to widen a structure it will usually be found that old parapets are in sufficiently good condition to be retained on the unaltered side, and re-used on the side of the widening. This is an appreciable saving over the cost of building entirely new parapets and is a course which should generally be adopted. If the old parapet is not re-used, it becomes evident when one considers the elevation of the widened part of the

work that in few cases will a satisfactory result be obtained unless the concrete is faced with stone. It is often possible to obtain the stone facing for the new widening from the same quarry as that from which the stone for the original structure was obtained. It is better to reproduce the elevation which is disturbed. Photographs should be taken of the old elevation, the stonework and pointing should be described in the specification, and items to cover their reproduction included in the schedule. If new stone is costly, the best treatment is probably to use the old parapet and to bush-hammer the concrete below, using an aggregate which matches the natural stone. *Fig. 220* shows a bridge before and after widening and shows how closely old work can be copied. The entire constructional work behind the stonework is of reinforced concrete.

In the following, typical examples of bridge widenings are described.

**1.—Cowie Bridge, Stonehaven.**—This was a case where the substructure required to be increased in width (see *Figs. 221 and 222*). The improvement necessitated a widening of 14 ft. 6 in. The bridge crosses the river Cowie by means of three spans each of approximately 23 ft. 6 in., and in addition the northern approach crosses a mill lade approximately 10 ft. wide. On the northern side the approach runs in direct line with the bridge, but immediately to the south there is a sharp curve into the main road through Stonehaven. Unfortunately on the south-east side of this road there is property in such a position that to have widened on this side would have necessitated the purchase of several houses and an increased cost entirely out of proportion to the advantage gained. In consequence, and as the substructure required to be increased in width, the widening was made entirely on the western side and the opportunity taken to improve the approach at the north-west end.

Provision is made for a clear width of 40 ft. between parapets, allocated as 30 ft. to the roadway and 5 ft. on each side to footpaths. The river under normal conditions is about 1 ft. deep at this point, but at times of flood it rises approximately 7 ft. above this level. The ground consists generally of loose gravel, becoming fairly solid at a depth of about 5 ft. below the river bed, and it is on this consolidated gravel that the old bridge and the new widening are founded.

Due to the comparative cheapness of concrete, resulting from a supply of aggregate being obtainable from the river bed, the abutments and the pier foundations are of plain concrete and are provided with only sufficient steel to form an adequate bond with the superstructure. The two river piers were formed within dams of 2-in. tongued-and-grooved boarding, backed up on the river side with the material from the excavations. Only a small quantity of water percolated through the bottom, and with the aid of a small pump it was found possible to place the concrete without damage. At approximately the bed of the existing stream a step was formed in the concrete abutments. From this level the whole of the work was faced with natural stone similar to that of which the old bridge was built and having a thickness of from 4 in. to 12 in. in different parts of the work. This stone facing was built up in short heights and jointed in cement mortar; the concrete being placed behind it, the best possible bond was obtained. Care was taken to moisten the stonework before the concrete was placed in order to prevent undue absorption of water from the concrete which might have reduced the bond between the two. Further to improve the key, copper dowels approximately 1 in. wide by  $\frac{1}{8}$  in. thick having slightly fish-tailed ends were built into



FIG. 221.  
[SEE OVERLEAF  
FOR FIG. 222]

COUNTY

DEG No 368-1

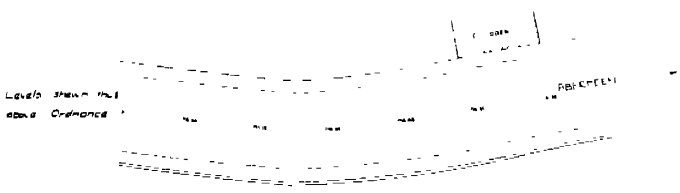
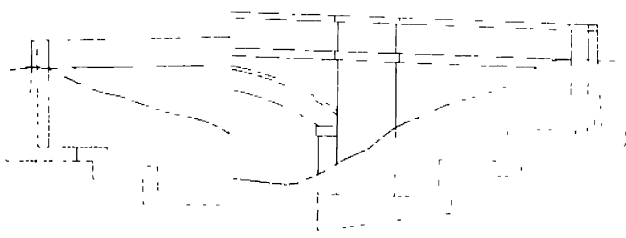

KINCAIDINESHIRE  
IDGE STONEHAVEN  
& SITE PLAN



BELL, COUNTY ENGINEER, STONEHAVEN



DRG. No. 371-2

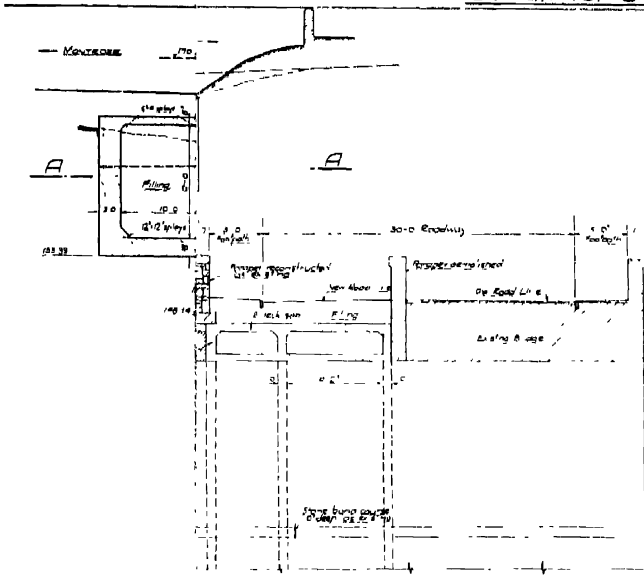

CROSS SECTION AT CROWN

COUNTY OF KINCARDINE  
BROTHERTON BRIDGE WIDENING

GENERAL LAYOUT

Scale 1/2" = 1'-0"

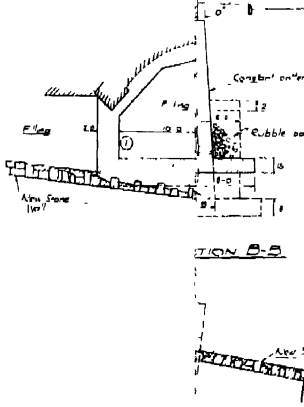

Note - The back face of the  
top slab of concrete  
shall be the maximum  
thickness of wall (including  
stone facing) being  
the thickness of the top  
slab (top slab) for out  
on site



the joints of the stonework and carried back into the concrete, there being approximately one dowel to each square yard of stone surface. The arch rings have a span of approximately 23 ft. 6 in. with rises of 3 ft. 5 in. in the side spans and 3 ft. 8 in. in the centre span; they are 20 in. thick at the springings and 10 in. thick at the crown. It was not considered necessary in view of the comparatively good foundation to provide any special joint between the existing structure and the new widening. In consequence the face of the existing structure was simply well cleaned and the new concrete placed against it, so providing some measure of bond. The culvert for the mill lade, which has a span of 11 ft. 3 in. and a rise of 5 ft. 7½ in. with a total height from invert to springing of arch of 5 ft. 5 in., has walls and arch ring 12 in. thick and a base slab 15 in. thick. This work was carried out during a week-end when it was possible to close the sluices and stop water running down the lade. Rapid-hardening Portland cement was used in



Fig. 224.—Brotherton Bridge (Widening).

[A CELLULAR CONSTRUCTION IN REINFORCED CONCRETE FACED WITH STONE TO REPRODUCE EXACTLY THE APPEARANCE OF THE ORIGINAL BRIDGE. SEE FIG. 223 FOR DETAILS.]

the invert slab, and it was found that when water was turned on after a lapse of only 2½ days no damage occurred. The appearance of the finished structure was specified to be exactly similar to the structure existing before the alteration. Photographs were taken before the work commenced in order that the appearance of the new work might be definitely verified (see Fig. 220). The old parapet wall and coping were re-used, but where necessary bad stones were replaced by new ones and a certain amount of new coping was also required. The work on the existing part of the bridge was re-pointed, and there is very little difference between the character of the stonework in the old structure and in the new, nor is there any difference in the general appearance of the two parts. This is an ideal state of affairs in such a scheme.

**2.—Brotherton Bridge.**—Widening and re-alignment, substructure increased in width (see Figs. 223, 224 and 225). The span of the arch of this bridge is 44 ft. in the clear, and the rise 14 ft. 5 in. The height from the stream bed to road level is 55 ft. 6 in. The widening varies in width from 23 ft. at one end to

14 ft. at the other, and, in addition, at the narrow end of the widening there is a re-alignment of the parapet on the opposite side of the bridge to give ultimately the best line for the finished road. In order to preserve the amenity of the site it was decided to reproduce the existing elevation exactly in the new structure both as regards surface finish and general outline. This, however, immediately presented a difficulty because the contour of the ground tended to throw the springing of the widening arch to a very considerable height above ground level, which would have necessitated in normal construction an abutment of very large size and consequent considerable cost. One or two designs were investigated, and it was found that the most economical and at the same time the most satisfactory method of dealing with the case would be to carry out the work in cellular construction with cellular abutments, the soffit of the beams being the shape of the existing arch. The foundations throughout were carried down to rock which occurs at a shallow depth below the surface of the sides of the ravine. The bases of all the abutment cells are 18 in. thick and are stepped as necessary to follow the general contour of the rock. The walls of the cells are generally 10 in. thick. The soffit slab forming the bottom of the cellular superstructure and following

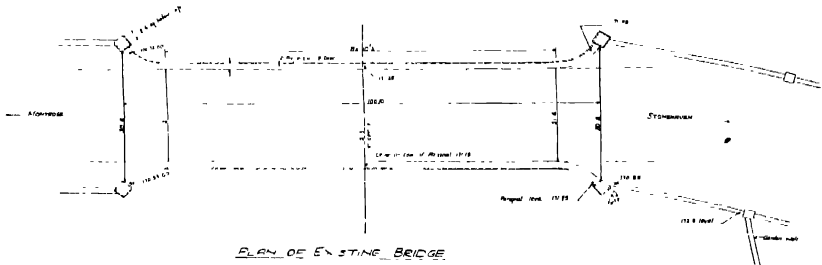
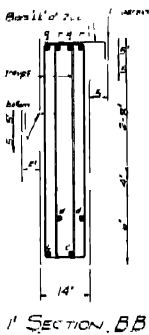
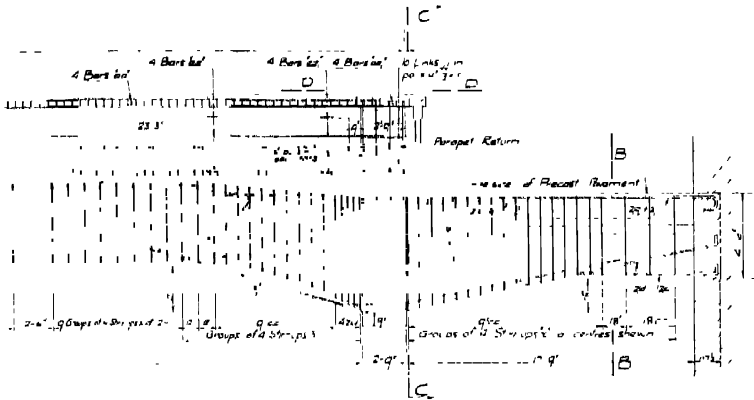

Fig. 225.—Brotherton Bridge.

the line of the existing arch is 6 in. thick. The deck slab is 8 in. thick and the ribs are 14 in. wide arranged as shown on the drawing (*Fig. 223*). Full advantage was taken of the fact that the beams were considerably deeper at the springing than at the crown, by taking into account the variation in moment of inertia along their length. They do, in fact, practically cantilever from the abutments. In order to produce the necessary counterbalance on the south side where the abutments are comparatively shallow they are filled to a certain level with earth. All the cell walls have drain holes through them, and should any water seep into the cells it will discharge through weep holes into the stream. The whole of the external elevation and the face of the abutment up to the springing line of the arch are faced with stone approximately 6 in. thick. It was considered unnecessary, and it would certainly have been very expensive, to face the underside of the arch with stone. The character of the stone and the type of jointing follow that in the earlier bridge. A photograph was taken of the original work in order to check that the finished structure (*Fig. 224*) as carried out is an exact replica. The stone facing is fixed by 1-in. by  $\frac{1}{8}$ -in. by 18-in. copper cramps, allowing one cramp per square yard of wall face. It will be noted that there



FIG. 227.



| SCHEDULE OF REINFORCING STEEL IN BEAM UNDER PARAPET |     |           |               |                     |     |     |           |               |                         |
|---|-----|-----------|---------------|---------------------|-----|-----|-----------|---------------|-------------------------|
| Bar No.   | Qty | Length    | BENDING       | REMARKS             | dia | Qty | Length    | BENDING       | REMARKS                 |
| a   | 12  | 5' 1"     | 2 @ 5' 1"     | Bottom Bars between | m   | 12  | 4' 7"     | 2 @ 4' 7"     | Upper Bars between Bars |
| b   | 12  | 6' 1"     | 2 @ 6' 1"     | Bottom Bars between | n   | 12  | 5' 7"     | 2 @ 5' 7"     | Upper Bars between Bars |
| c   | 12  | 6' 3"     | 2 @ 6' 3"     | Bottom Bars between | p   | 12  | 5' 9"     | 2 @ 5' 9"     | Upper Bars between Bars |
| d   | 2   | 15' 5' 8" | 1 @ 15' 5' 8" | Bottom Bars between | q   | 2   | 15' 5' 8" | 1 @ 15' 5' 8" | Upper Bars between Bars |
| e   | 12  | 15' 4' 5" | 2 @ 15' 4' 5" | Bottom Bars between | r   | 12  | 14' 11"   | 2 @ 14' 11"   | Upper Bars between Bars |
| f   | 12  | 15' 0"    | 2 @ 15' 0"    | Bottom Bars between | s   | 12  | 13' 8"    | 2 @ 13' 8"    | Upper Bars between Bars |
| g   | 12  | 15' 0"    | 2 @ 15' 0"    | Bottom Bars between | t   | 12  | 14' 10"   | 2 @ 14' 10"   | Upper Bars between Bars |
| h   | 12  | 15' 0"    | 2 @ 15' 0"    | Bottom Bars between | u   | 12  | 14' 10"   | 2 @ 14' 10"   | Upper Bars between Bars |
| i   | 12  | 15' 0"    | 2 @ 15' 0"    | Bottom Bars between | v   | 12  | 14' 10"   | 2 @ 14' 10"   | Upper Bars between Bars |
| j   | 12  | 15' 0"    | 2 @ 15' 0"    | Bottom Bars between | w   | 12  | 14' 10"   | 2 @ 14' 10"   | Upper Bars between Bars |
| k   | 12  | 15' 0"    | 2 @ 15' 0"    | Bottom Bars between | x   | 12  | 14' 10"   | 2 @ 14' 10"   | Upper Bars between Bars |
| l   | 12  | 15' 0"    | 2 @ 15' 0"    | Bottom Bars between | y   | 12  | 14' 10"   | 2 @ 14' 10"   | Upper Bars between Bars |

| SCHEDULE OF REINFORCING STEEL IN PARAPET & BEAM CONNECTIONS |    |    |        |          |    |    |    |        |          |
|---|----|----|--------|----------|----|----|----|--------|----------|
| oo  | 20 | 1' | 20' 9" | SHOULDER | 16 | 4  | 5' | 20' 9" | SHOULDER |
| oo  | 4  | 1' | 20' 9" | SHOULDER | 17 | 12 | 9  | 6' 0"  | SHOULDER |
| oo  | 23 | 4' | 4' 9"  | SHOULDER | 18 | 10 | 5' | 5' 0"  | SHOULDER |
| oo  | 23 | 3' | 5' 0"  | SHOULDER | 19 | 10 | 5' | 4' 0"  | SHOULDER |
| oo  | 20 | 1' | 20' 9" | SHOULDER | 20 | 12 | 9  | 6' 0"  | SHOULDER |

| SCHEDULE OF REINFORCING STEEL IN BEAM UNDER PARAPET RETURN |    |    |        |                   |   |    |    |    |                           |
|--|----|----|--------|-------------------|---|----|----|----|---------------------------|
| A  | 4  | 1' | 16' 0" | Top + Bottom Bars | C | 20 | 3' | 0" | Splicing with bar of size |
| B  | 26 | 3' | 4' 3"  | Top + Bottom Bars |   |    |    |    |                           |

Note 15' max to be allowed between the individual groups in each group thus

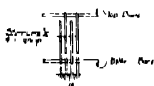

Edinburgh.



arc tunnels through the abutments of the bridge at both ends. These serve no useful structural purpose, but apparently were intended in the original scheme to provide pathways through from one side of the bridge to the other. They have been carried through on the widening work to preserve the elevation and they certainly have the effect of relieving what would otherwise be a rather large expanse of plain wall.

The re-alignment of the parapet of the bridge on the opposite side from the widening has been carried out by cleaning the face of the existing work from the centre of the arch down to the base of the abutment on the one side, the adjoining ground being excavated down to rock. Holes were cut at intervals in the existing work; into these copper ties were grouted and left projecting to bond with the concrete work in the widening. The widening may be considered as simply a pier built up adjacent to the existing abutment and keyed thereto with a cantilever projection towards the centre of the existing arch with which it bonds and into which it fades at the crown of the old arch. The old parapet wall has been re-used and a certain amount of re-alignment made in the walls beyond the approaches of the bridge at both ends to provide satisfactory alignment of the finished road. The approaches to the bridge have been well balanced at both ends to give a pleasing effect as one enters on the bridge. The widened bridge is a very great improvement and the most economical treatment for this case. As already noted in a general way, however, the finished work does not provide either an alignment or a contour quite so ideal as could have been chosen if an entirely new structure had been erected, but this would have involved almost twice the expenditure and much difficulty in keeping the roadway open during reconstruction.

**3.—Junction Street Bridge, Edinburgh.**—A case in which the substructure required no strengthening is shown in *Figs. 226, 227, and 228*. This bridge is on the main road from Edinburgh to Leith. The old structure has an overall width, outside to outside of parapets, of 30 ft. and it was found necessary approximately to double the overall width of the roadway. The old construction consisted of a masonry arch having a clear span of 70 ft., and a rise from springing to extrados at crown of 19 ft. This arch was carried by mass masonry abutments and the extrados of the arch had constructed above it a series of spandrel walls as shown on *Fig. 226*. In the first place examination was made of the foundation and analysis made of the stresses in the existing arch ring. As a result the conclusion was arrived at that the foundations as they stood would be sufficient to carry the whole of the increased width of the bridge. This therefore forms one of the cases in which the supports are carried up from the top of the existing abutment to a level approximately that of the new roadway. Beams and cantilevers cross the abutments to carry the increased width. Between the cantilevers, which are clearly shown on the drawings, and on both sides three beams span on each side of the bridge, one directly underneath the parapets, one underneath the kerb forming the boundary of the roadway and one close up to the existing work. The abutment of the existing bridge projected approximately 5 ft. on each side beyond the face of the spandrel walls, and this made it necessary to provide a clear overhang of 10 ft.  $4\frac{1}{2}$  in. on each side of the bridge. The face of the new cantilever beams is set back from the springing line of the old arch approximately 2 ft. 6 in., thus giving a clear span of 75 ft. for the new girders. The girders below the parapet measure 6 ft. in depth by 14 in. in width; those below the kerb are

7 ft. 6 in. in depth by 14 in. in width ; those immediately adjacent to the existing work are 5 ft. 6 in. deep by 16 in. in width. The new footpaths have a clear width of 9 ft., and below each of them is provided a pipe-duct the full width of the path and having a total depth from footpath level of 2 ft. 9 in. These ducts contain only the pipes and cables, and are not filled in. The footpaths over them consist of pre-cast reinforced concrete slabs spanning between a ledge formed on the parapet beams and a rebate formed on the inside of the kerb. The roadway between the face of the existing structure and the kerb beam is carried by a 5-in. reinforced concrete slab. Over the slab there is approximately 1 ft. 6 in.

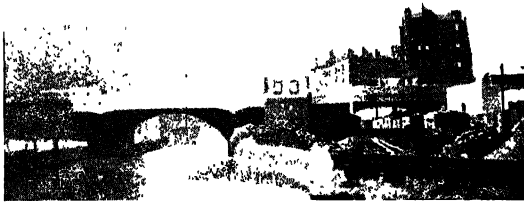

SIDE VIEW SHOWING WIDENING

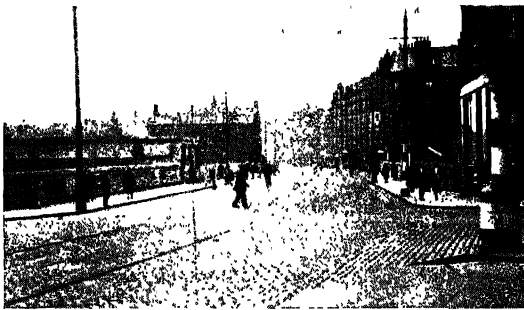

VIEW SHOWING WIDENED ROADWAY.

Fig. 228.—Junction Street Bridge, Edinburgh.

of filling up to the new road level. The second span of this widening consists of the addition of a 9-ft. wide footpath to an existing bridge over the adjoining railway line. In this case, due to the necessity of avoiding staging below the work, it was carried out in a similar manner to the widening over the river but using plate girders encased in concrete, the plate girders being of sufficient strength to carry the whole of the load and arranged so that they would support the shuttering for the concrete during construction.

This forms a particularly good example of a bridge widening construction where the existing foundations are sufficient to carry the whole of the load of the widened work. It should be noted, however, that there are not many cases

where the existing foundations are capable of carrying the load from a width double that of the existing structure. In cases, however, where there is a large abutment similar to that existing in the case in question it is frequently possible to increase the total vertical loading appreciably if the point of application of the increased load is carefully chosen to produce an absolutely uniform load over the total width of foundation taking into account the thrust from the arch, the load of the foundation itself and the superimposed load from the new work. The new structure carries two tramway lines and extremely heavy traffic to and from the docks. It has now been in service since the late 1920's. The photographs (*Fig. 228*) give some indication of the appearance of the finished work both from the roadway and from the side. Whilst the construction has not improved the appearance of the old bridge it has not seriously affected it, and in any case the structure as it now stands is equal in appearance to many buildings in the neighbourhood.

The three examples given are typical of many cases met with in actual practice. Each is dealt with in an entirely different manner chosen to meet the special requirements of the case. The wide variation in treatment is some indication of the thought required to deal with bridge widenings and re-alignments in the most satisfactory and economical manner.

### **Strength of Existing Concrete Bridges.**

The remarks in this chapter on the condition and strength of existing bridges are limited to masonry structures. In some cases the engineer may have to assess the strength of existing reinforced concrete bridges and, as such bridges have usually been constructed within the last half century, it is probable that detail drawings are available, in which case it is only necessary to ensure, by comparing the drawings with the structure, that the latter has been built in accordance with the drawings. It is obviously only possible to check by superficial measurement that the sizes conform to the details. The accuracy of the reinforcement is more difficult to determine. Knowledge of the names of the designer and contractor may assist in deciding whether accuracy is likely, but unless some form of examination is made the correctness of the amount and position of the reinforcement can remain only an assumption. It may therefore be advisable to remove a small amount of concrete cover to expose the reinforcement at a few critical places to determine the condition, position, and possibly the amount, of steel. New cover can subsequently be placed by cement-gun. Elsewhere the position of the reinforcement may be partially determined by electrical exploration or similar means.

Examination of the structure should take cognisance of the position, extent, number, and penetration of any cracks in the concrete, and the extent of any spalling or other deterioration. Cores cut from the concrete may be examined for soundness and strength (the cavities being made good with new well-compacted concrete), bearing in mind, however, that the relation of the strength of such cores to, say, the 28-day cube strength has not yet been definitely established. Foundations should be examined as already described for masonry bridges.

In special cases a test loading of the bridge may be justified. By means of strain gauges and deflectometers the increase in stress and deformation due to the test loads can be determined. Such tests cannot, however, reveal the existing

stresses due to dead load, shrinkage, yield, fatigue, and possible foundation settlement, which may be high compared with the increase in stress due to live load. Further, measured stresses in reinforced concrete structures are frequently considerably less than the calculated stresses.

When the engineer is satisfied about the design and physical characteristics of the bridge, it remains to assess the strength of the structure, that is the estimated ability of the bridge to carry live load. This entails the determination of the weakest section of the composing members in relation to the calculated bending moments and shears. In computing the bending moments it may be necessary to take into account cracks that may have produced virtual points of contraflexure in positions not intended by the designer. The safe working stresses should be assessed on the known strengths of the steel and concrete, or, if these are not available, the design stresses required at the time the bridge was designed may be a guide. Obviously, the factor of safety applied to an existing bridge should bear some relation to the accuracy of the established facts relevant to the strength of the structure.

## CHAPTER XI

### OFFICE PRACTICE

ROUTINE—DRAUGHTSMANSHIP—CALCULATIONS AND GENERAL DRAWINGS  
—DETAILING—CHECKING—STEEL SHEETS—SPECIFICATION—BILLS OF  
QUANTITIES

IN this chapter it is first intended to give a general outline of the steps which are taken in the drawing office in the preparation of the complete design and particulars for a reinforced concrete bridge, after which each of the steps will be discussed in some detail.

When the survey notes are received from the site it is necessary to plot them, a scale of 20 ft. to 1 in. being generally suitable to show the site of the bridge and sufficient length of road on both sides without the drawing becoming unreasonably large. In addition to this, however, it is advisable to plot the actual site of the bridge to a scale of 8 ft. to 1 in. This plotting will form the basis of the scheme plan, which will include the positions of abutments and piers, the lines of approach walls, and any supplementary work included. In the preparation of the scheme plans investigation of several designs will often be required before the most economical and effective proposal is found. These alternatives are usually drafted very roughly and based on quick approximate calculations both as to strength and cost. The general principles outlined in preceding chapters together with the engineer's experience will assist in an early choice of the most suitable scheme. The cross-sections through the various parts of the structure should usually be drawn to a larger scale, say 4 ft. to 1 in., to show clearly the construction proposed. The elevation should also be prepared at this stage, keeping in view the amenity of the site as well as the need for economy. The preparation of the final scheme plans will entail a certain amount of calculation, although at this stage it is desirable to reduce the labour on these as much as possible by means of approximations, as these scheme plans usually require to be approved by the client, and possibly by Government authorities, before a final decision is made to proceed with the work on the scheme as outlined.

The next item of importance is the preparation of the engineer's estimate. Whilst this should cover all the work necessary to erect the structure, it is again desirable to limit the number of items in the estimated quantities as much as possible. From examination of priced schedules it will frequently be found that contractors place the same rate against practically the whole of the concrete work no matter to what degree it may be sub-divided. It is quite reasonable, therefore, in preparing the preliminary estimate to take out the whole of the mass concrete-work in one item and the whole of the reinforced concrete work

as another and place reasonable rates against them. Shuttering, excavations, surface finish, road finish, engineers' fees, clerk of works, the cost of property, etc., should all be included in this estimate so that the first figure given to the client shall be sufficient to cover the whole of the expenditure on the scheme. It is advisable, also, to include in this estimate an adequate sum for contingencies. The amount of this should be decided from a consideration of the site conditions. As a rule, work above foundations is fairly straightforward, and provided the scheme and schedule have been well drafted there is not likely to be any considerable increase of the expenditure on the superstructure over the preliminary estimate amount. The foundations, however, are an entirely different matter and the amount allowed for contingencies will be governed to a great degree by the type of sub-foundation disclosed during the investigations at the site. If the engineer definitely knows the levels at which rock will be encountered and it is his intention to found on that rock the contingency item need be only small, but it is seldom that he can be quite certain of the strata below ground level over the whole site. Where the ground is likely to vary appreciably the contingency item must be fairly considerable. Generally it should not be less than 5 per cent. of the cost of construction; a usual figure is 10 per cent. and on exceptional sites it might be so high as 20 per cent.

At this stage one should submit to the client the following particulars:

- (1) General arrangement plan (say 20 ft to 1 in.) showing bridge and approaches,
- (2) Detail arrangement drawings showing construction proposed,
- (3) Elevation of the proposed bridge,
- (4) Engineer's estimate for the work, and
- (5) Brief general report on the scheme.

On approval of the scheme and instructions being received from the client to proceed, the engineer can commence to prepare the detail drawings and contract documents.

Whilst it is possible to show the whole details of the work and reinforcement details on one set of drawings, it has been found from experience that this often leads to confusion and lack of clarity on the site. It is better practice to prepare complete plans showing the outlines of the whole of the concrete work fully dimensioned, so that the work may be set out and the whole of the shuttering and external work prepared from them without reference to the reinforcement details. In other words, this set of drawings includes details of everything except the reinforcing steel. In the event of urgency to commence construction, tenders may be obtained on these drawings with the addition, perhaps, of a typical reinforcement detail. Specification and quantities may be prepared from them, the amount of steel reinforcement being approximately computed on the basis of pounds weight of steel per unit length of member, without waiting for the steel to be taken off bar by bar from the reinforcement details. If time permits, however, it is better to prepare the reinforcement details before sending out for tenders, so that the amount of steel may be accurately ascertained and contractors may have the fullest details regarding the work for which they are asked to tender. The reinforcement details should form a complete set of drawings giving all the necessary information for the



steel benders and fixers to carry out their work without reference to other drawings. As a rule these details must be drawn to a scale of 2 ft. to 1 in., although in cases of large structures with comparatively simple reinforcement it may be convenient to draw them to a scale of 1 ft. to  $\frac{3}{4}$  in. to keep the sizes of drawings to convenient dimensions. Plans of deck slabs and similar work may be drawn and the details clearly shown to a scale of 4 ft. to 1 in., although the cross-sections of such slabs should be to a scale of 2 ft. to 1 in. These details are best arranged to include complete bending schedules on which every bar in the structure should be shown diagrammatically and the bending dimensions given. The drawings reproduced in *Figs. 229, 230, 231, and 232* illustrate respectively a typical general arrangement, detail arrangement, detailed outline drawing, and reinforcement detail from the sets prepared for four different bridges.

Finally, so far as the drawing work is concerned, one or two further details may be required to show work other than reinforced concrete required in the structure. These may include such items as lamp standards, cover plates to expansion joints, manholes, pipe connections, flap valves to weep holes, etc.

### Draughtsmanship.

Due to the necessity of drawing the details of the reinforcement to a comparatively large scale, usually 2 ft. to 1 in., it is more convenient for reference purposes, both in the office and at the site, to adhere throughout to the architectural scales of 3 in., 1½ in., 1 in.,  $\frac{1}{2}$  in.,  $\frac{3}{8}$  in.,  $\frac{1}{4}$  in., and  $\frac{1}{8}$  in. to 1 ft. Drawings should be made of a convenient size. The width standardised by the Ministry of Transport—26¾ in. overall—is very suitable. Whilst the width may be standardised in this way, it is inconvenient to standardise the length; this should be not more than 54 in., or 42 in. if possible, but if this is unsuitable in any particular case and would necessitate the division of a view which would be better shown on one drawing, then the length may be increased. When this is done it is wise to make a definite fold in the linen tracing of the drawing at once to ensure that it will fit easily into the filing cabinet. If such a fold is made in the first instance, whilst it will cause some disfigurement to prints taken from the tracing, it will avoid the indiscriminate creasing which results if a definite fold is not made and will preserve the clarity of the prints, which is the first consideration. To give as much room as possible for the drawing, borders  $\frac{1}{2}$  in. deep are advisable and in addition these give a good appearance to the finished work. To meet the wishes of the Ministry of Transport the title of the drawings should be placed across the top. For this purpose a line 1½ in. below the top border line may be drawn and the title and number of the drawing written in the enclosed space. In addition, however, where drawings are filed in drawers, it will usually be found convenient for quick reference to have a title at the lower right-hand corner. In the bottom right-hand corner also should be printed the reference number of the scheme, the number of the drawing, the initials of the designer, draughtsman, tracer, and checker, the date on which the drawing is finally passed out for use, and dates of any revisions. These particulars are given in *Fig. 233*.



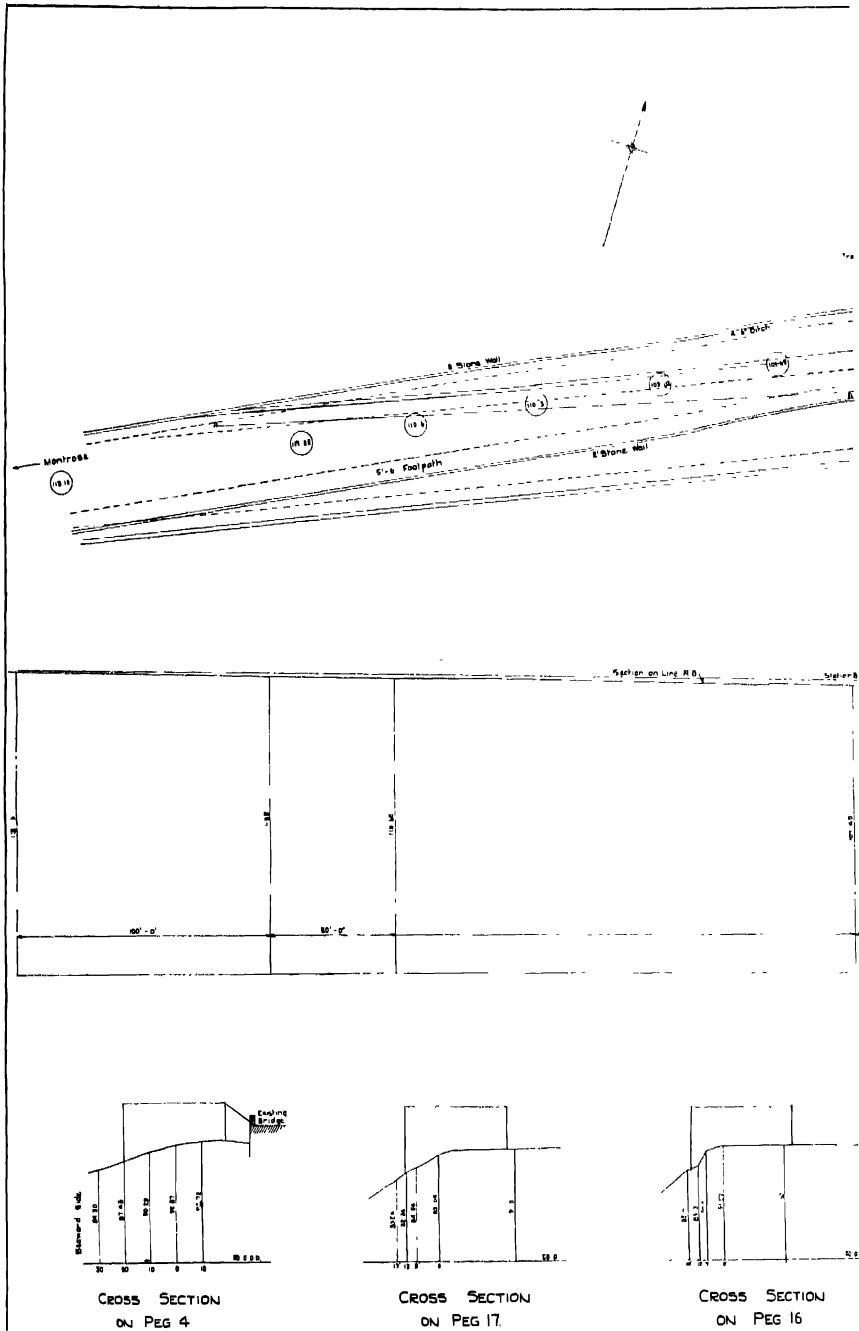

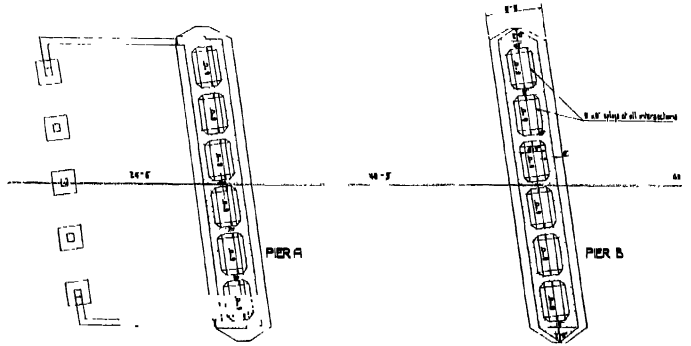
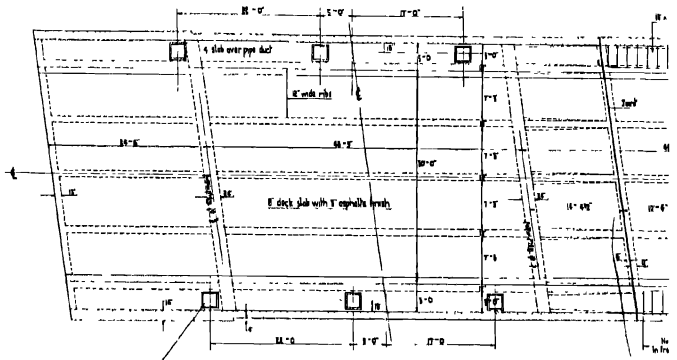

HALF SECTIONAL PLAN OF PIERS.

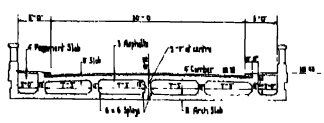

SECTION A-A.

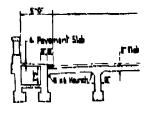

SEC

FIG. 232.

SCHEDULE OF STEEL REINFORCEMENT

| PART                       | MEMBER REF. | BAR | NO. | TOTAL FT. | DIA.   | LENGTH  | BENDING   | WEIGHT | LBS. | BAR | NO. | TOTAL FT. | DIA.   | LENGTH | BENDING       |                                       |
|----------------------------|-------------|-----|-----|-----------|--------|---|---|--------|------|-----|-----|-----------|--------|--------|---------------|---------------------------------------|
|                            |             |     |     |           |        |   |   |        |      |     |     |           |        |        |               | NO.                                   |
| INTERIOR LONGITUDINAL RIBS | K           | a   | 2   | 16        | 1/2"   | 41'-8"  |   |        |      | B   | a   | 2         | 16     | 1/2"   | 48'-0"        |                                       |
|                            |             | b   | 2   | 16        | 1/2"   | 28'-6"  |   |        |      |     | a   | 2         | 16     | 1/2"   | 36'-0"        | As bar K16 a but dimension x = 10'-0" |
|                            | c           | 2   | 16  | 1/2"      | 41'-3" | 7 LH Thread   |   |        |      | d   | 4   | 32        | 1/2"   | 50'-3" |               |                                       |
|                            | K6          | a   | 2   | 16        | 1/2"   | 46'-9"  | As bar K6 a but dimension x = 12'-4"                          |        |      | e   | 2   | 16        | 1/2"   | 50'-3" |               |                                       |
|                            |             | b   | 2   | 16        | 1/2"   | 28'-6"  | As bar K6 b   |        |      | f   | 2   | 16        | 1/2"   | 51'-0" |               |                                       |
|                            |             | c   | 2   | 16        | 1/2"   | 36'-3"  | 7 LH Thread   |        |      | g   | 4   | 32        | 1/2"   | 57'-6" |               |                                       |
|                            | K9          | a   | 6   | 48        | 1/2"   | 29'-3"  |   |        |      | h   | 2   | 16        | 1/2"   | 29'-6" |               |                                       |
|                            |             | b   | 6   | 48        | 1/2"   | 47'-0"  |   |        |      | i   | 4   | 32        | 1/2"   | 26'-3" |               |                                       |
|                            |             | c   | 6   | 48        | 1/2"   | 48'-9"  |   |        |      | j   | 4   | 32        | 1/2"   | 27'-9" |               |                                       |
|                            | K5          | a   | 1   | 8         | 1/2"   | 23'-0"  |   |        |      | k   | 2   | 16        | 1/2"   | 27'-9" |               |                                       |
|                            |             | b   | 1   | 8         | 1/2"   | 27'-3"  |   |        |      | l   | 4   | 32        | 1/2"   | 16'-6" |               |                                       |
|                            |             | c   | 1   | 8         | 1/2"   | 31'-0"  | 7 LH Thread   |        |      | m   | 4   | 32        | 1/2"   | 41'-0" |               |                                       |
|                            | K6          | a   | 1   | 8         | 1/2"   | 23'-0"  | As bar K5 a   |        |      | n   | 4   | 32        | 1/2"   | 41'-0" |               |                                       |
|                            |             | b   | 1   | 8         | 1/2"   | 27'-3"  | As bar K5 b   |        |      | o   | 4   | 32        | 1/2"   | 41'-0" |               |                                       |
|                            |             | c   | 1   | 8         | 1/2"   | 42'-0"  | 7 LH Thread   |        |      | 12  | 86  | 12        | 1/2"   | 12'-3" | Upright Links |                                       |
|                            | K7          | a   | 1   | 8         | 1/2"   | 32'-0"  | As bar K5 a but dimension x = 16'-0" on steel 16'-2" on steel |        |      | 13  | 86  | 12        | 1/2"   | 12'-3" | Do            |                                       |
|                            |             | b   | 1   | 8         | 1/2"   | 40'-0"  |   |        |      | 14  | 86  | 12        | 1/2"   | 12'-3" | Do            |                                       |
|                            |             | c   | 1   | 8         | 1/2"   | 30'-0"  | As bar K5 a but dimension x = 16'-0" on steel 16'-2" on steel |        |      | 15  | 120 | 15        | 1/2"   | 10'-9" | Do            |                                       |
|                            | K8          | a   | 1   | 8         | 1/2"   | 30'-0"  | As bar K5 a but dimension x = 16'-0" on steel 16'-2" on steel |        |      | 16  | 120 | 15        | 1/2"   | 11'-9" | Do            |                                       |
|                            |             | b   | 1   | 8         | 1/2"   | 34'-0"  |   |        |      | 17  | 120 | 15        | 1/2"   | 12'-9" | Do            |                                       |
| c                          |             | 2   | 16  | 1/2"      | 30'-0" | As bar K5 a but dimension x = 16'-0" on steel 16'-2" on steel |   |        | 18   | 144 | 18  | 1/2"      | 12'-9" | Do     |               |                                       |
| K9                         | a           | 2   | 16  | 1/2"      | 30'-0" | As bar K5 a but dimension x = 16'-0" on steel 16'-2" on steel |   |        | 19   | 144 | 18  | 1/2"      | 12'-9" | Do     |               |                                       |
|                            | b           | 2   | 16  | 1/2"      | 32'-0" |   |   |        | 20   | 144 | 18  | 1/2"      | 12'-9" | Do     |               |                                       |
|                            | c           | 2   | 16  | 1/2"      | 30'-0" | As bar K5 a but dimension x = 16'-0" on steel 16'-2" on steel |   |        | 21   | 144 | 18  | 1/2"      | 12'-9" | Do     |               |                                       |
| K10                        | a           | 1   | 8   | 1/2"      | 50'-0" |   |   |        | 22   | 144 | 18  | 1/2"      | 12'-9" | Do     |               |                                       |
|                            | b           | 1   | 8   | 1/2"      | 26'-6" |   |   |        | 23   | 144 | 18  | 1/2"      | 12'-9" | Do     |               |                                       |
|                            | c           | 1   | 8   | 1/2"      | 30'-0" | As bar K10 a  |   |        | 24   | 144 | 18  | 1/2"      | 12'-9" | Do     |               |                                       |
| K11                        | a           | 1   | 8   | 1/2"      | 50'-0" | As bar K10 a  |   |        | 25   | 144 | 18  | 1/2"      | 12'-9" | Do     |               |                                       |
|                            | b           | 1   | 8   | 1/2"      | 17'-6" |   |   |        | 26   | 144 | 18  | 1/2"      | 12'-9" | Do     |               |                                       |
|                            | c           | 1   | 8   | 1/2"      | 17'-6" |   |   |        | 27   | 144 | 18  | 1/2"      | 12'-9" | Do     |               |                                       |
| K12                        | a           | 1   | 8   | 1/2"      | 26'-6" | As bar K10 a but dimension x = 0'-10"                         |   |        | 28   | 144 | 18  | 1/2"      | 12'-9" | Do     |               |                                       |
|                            | b           | 1   | 8   | 1/2"      | 35'-0" | 7 LH Thread   |   |        | 29   | 144 | 18  | 1/2"      | 12'-9" | Do     |               |                                       |
| K13                        | a           | 1   | 8   | 1/2"      | 26'-6" | As bar K10 a but dimension x = 0'-10"                         |   |        | 30   | 144 | 18  | 1/2"      | 12'-9" | Do     |               |                                       |
|                            | b           | 1   | 8   | 1/2"      | 29'-0" | 7 LH Thread   |   |        | 31   | 144 | 18  | 1/2"      | 12'-9" | Do     |               |                                       |
| K14                        | a           | 1   | 8   | 1/2"      | 26'-6" | As bar K10 a but dimension x = 0'-10"                         |   |        | 32   | 144 | 18  | 1/2"      | 12'-9" | Do     |               |                                       |
|                            | b           | 1   | 8   | 1/2"      | 29'-0" | 7 LH Thread   |   |        | 33   | 144 | 18  | 1/2"      | 12'-9" | Do     |               |                                       |
| K15                        | a           | 1   | 8   | 1/2"      | 26'-6" | As bar K10 a but dimension x = 0'-10"                         |   |        | 34   | 144 | 18  | 1/2"      | 12'-9" | Do     |               |                                       |
|                            | b           | 1   | 8   | 1/2"      | 29'-0" | 7 LH Thread   |   |        | 35   | 144 | 18  | 1/2"      | 12'-9" | Do     |               |                                       |
| K16                        | a           | 1   | 8   | 1/2"      | 26'-6" | As bar K10 a but dimension x = 0'-10"                         |   |        | 36   | 144 | 18  | 1/2"      | 12'-9" | Do     |               |                                       |
|                            | b           | 1   | 8   | 1/2"      | 29'-0" | 7 LH Thread   |   |        | 37   | 144 | 18  | 1/2"      | 12'-9" | Do     |               |                                       |
| K17                        | a           | 1   | 8   | 1/2"      | 26'-6" | As bar K10 a but dimension x = 0'-10"                         |   |        | 38   | 144 | 18  | 1/2"      | 12'-9" | Do     |               |                                       |
|                            | b           | 1   | 8   | 1/2"      | 29'-0" | 7 LH Thread   |   |        | 39   | 144 | 18  | 1/2"      | 12'-9" | Do     |               |                                       |
| K18                        | a           | 1   | 8   | 1/2"      | 26'-6" | As bar K10 a but dimension x = 0'-10"                         |   |        | 40   | 144 | 18  | 1/2"      | 12'-9" | Do     |               |                                       |
|                            | b           | 1   | 8   | 1/2"      | 29'-0" | 7 LH Thread   |   |        | 41   | 144 | 18  | 1/2"      | 12'-9" | Do     |               |                                       |
| K19                        | a           | 1   | 8   | 1/2"      | 26'-6" | As bar K10 a but dimension x = 0'-10"                         |   |        | 42   | 144 | 18  | 1/2"      | 12'-9" | Do     |               |                                       |
|                            | b           | 1   | 8   | 1/2"      | 29'-0" | 7 LH Thread   |   |        | 43   | 144 | 18  | 1/2"      | 12'-9" | Do     |               |                                       |
| K20                        | a           | 1   | 8   | 1/2"      | 26'-6" | As bar K10 a but dimension x = 0'-10"                         |   |        | 44   | 144 | 18  | 1/2"      | 12'-9" | Do     |               |                                       |
|                            | b           | 1   | 8   | 1/2"      | 29'-0" | 7 LH Thread   |   |        | 45   | 144 | 18  | 1/2"      | 12'-9" | Do     |               |                                       |
| K21                        | a           | 1   | 8   | 1/2"      | 26'-6" | As bar K10 a but dimension x = 0'-10"                         |   |        | 46   | 144 | 18  | 1/2"      | 12'-9" | Do     |               |                                       |
|                            | b           | 1   | 8   | 1/2"      | 29'-0" | 7 LH Thread   |   |        | 47   | 144 | 18  | 1/2"      | 12'-9" | Do     |               |                                       |
| K22                        | a           | 1   | 8   | 1/2"      | 26'-6" | As bar K10 a but dimension x = 0'-10"                         |   |        | 48   | 144 | 18  | 1/2"      | 12'-9" | Do     |               |                                       |
|                            | b           | 1   | 8   | 1/2"      | 29'-0" | 7 LH Thread   |   |        | 49   | 144 | 18  | 1/2"      | 12'-9" | Do     |               |                                       |
| K23                        | a           | 1   | 8   | 1/2"      | 26'-6" | As bar K10 a but dimension x = 0'-10"                         |   |        | 50   | 144 | 18  | 1/2"      | 12'-9" | Do     |               |                                       |
|                            | b           | 1   | 8   | 1/2"      | 29'-0" | 7 LH Thread   |   |        | 51   | 144 | 18  | 1/2"      | 12'-9" | Do     |               |                                       |
| K24                        | a           | 1   | 8   | 1/2"      | 26'-6" | As bar K10 a but dimension x = 0'-10"                         |   |        | 52   | 144 | 18  | 1/2"      | 12'-9" | Do     |               |                                       |
|                            | b           | 1   | 8   | 1/2"      | 29'-0" | 7 LH Thread   |   |        | 53   | 144 | 18  | 1/2"      | 12'-9" | Do     |               |                                       |
| K25                        | a           | 1   | 8   | 1/2"      | 26'-6" | As bar K10 a but dimension x = 0'-10"                         |   |        | 54   | 144 | 18  | 1/2"      | 12'-9" | Do     |               |                                       |
|                            | b           | 1   | 8   | 1/2"      | 29'-0" | 7 LH Thread   |   |        | 55   | 144 | 18  | 1/2"      | 12'-9" | Do     |               |                                       |
| K26                        | a           | 1   | 8   | 1/2"      | 26'-6" | As bar K10 a but dimension x = 0'-10"                         |   |        | 56   | 144 | 18  | 1/2"      | 12'-9" | Do     |               |                                       |
|                            | b           | 1   | 8   | 1/2"      | 29'-0" | 7 LH Thread   |   |        | 57   | 144 | 18  | 1/2"      | 12'-9" | Do     |               |                                       |
| K27                        | a           | 1   | 8   | 1/2"      | 26'-6" | As bar K10 a but dimension x = 0'-10"                         |   |        | 58   | 144 | 18  | 1/2"      | 12'-9" | Do     |               |                                       |
|                            | b           | 1   | 8   | 1/2"      | 29'-0" | 7 LH Thread   |   |        | 59   | 144 | 18  | 1/2"      | 12'-9" | Do     |               |                                       |
| K28                        | a           | 1   | 8   | 1/2"      | 26'-6" | As bar K10 a but dimension x = 0'-10"                         |   |        | 60   | 144 | 18  | 1/2"      | 12'-9" | Do     |               |                                       |
|                            | b           | 1   | 8   | 1/2"      | 29'-0" | 7 LH Thread   |   |        | 61   | 144 | 18  | 1/2"      | 12'-9" | Do     |               |                                       |
| K29                        | a           | 1   | 8   | 1/2"      | 26'-6" | As bar K10 a but dimension x = 0'-10"                         |   |        | 62   | 144 | 18  | 1/2"      | 12'-9" | Do     |               |                                       |
|                            | b           | 1   | 8   | 1/2"      | 29'-0" | 7 LH Thread   |   |        | 63   | 144 | 18  | 1/2"      | 12'-9" | Do     |               |                                       |
| K30                        | a           | 1   | 8   | 1/2"      | 26'-6" | As bar K10 a but dimension x = 0'-10"                         |   |        | 64   | 144 | 18  | 1/2"      | 12'-9" | Do     |               |                                       |
|                            | b           | 1   | 8   | 1/2"      | 29'-0" | 7 LH Thread   |   |        | 65   | 144 | 18  | 1/2"      | 12'-9" | Do     |               |                                       |
| K31                        | a           | 1   | 8   | 1/2"      | 26'-6" | As bar K10 a but dimension x = 0'-10"                         |   |        | 66   | 144 | 18  | 1/2"      | 12'-9" | Do     |               |                                       |
|                            | b           | 1   | 8   | 1/2"      | 29'-0" | 7 LH Thread   |   |        | 67   | 144 | 18  | 1/2"      | 12'-9" | Do     |               |                                       |
| K32                        | a           | 1   | 8   | 1/2"      | 26'-6" | As bar K10 a but dimension x = 0'-10"                         |   |        | 68   | 144 | 18  | 1/2"      | 12'-9" | Do     |               |                                       |
|                            | b           | 1   | 8   | 1/2"      | 29'-0" | 7 LH Thread   |   |        | 69   | 144 | 18  | 1/2"      | 12'-9" | Do     |               |                                       |
| K33                        | a           | 1   | 8   | 1/2"      | 26'-6" | As bar K10 a but dimension x = 0'-10"                         |   |        | 70   | 144 | 18  | 1/2"      | 12'-9" | Do     |               |                                       |
|                            | b           | 1   | 8   | 1/2"      | 29'-0" | 7 LH Thread   |   |        | 71   | 144 | 18  | 1/2"      | 12'-9" | Do     |               |                                       |
| K34                        | a           | 1   | 8   | 1/2"      | 26'-6" | As bar K10 a but dimension x = 0'-10"                         |   |        | 72   | 144 | 18  | 1/2"      | 12'-9" | Do     |               |                                       |
|                            | b           | 1   | 8   | 1/2"      | 29'-0" | 7 LH Thread   |   |        | 73   | 144 | 18  | 1/2"      | 12'-9" | Do     |               |                                       |
| K35                        | a           | 1   | 8   | 1/2"      | 26'-6" | As bar K10 a but dimension x = 0'-10"                         |   |        | 74   | 144 | 18  | 1/2"      | 12'-9" | Do     |               |                                       |
|                            | b           | 1   | 8   | 1/2"      | 29'-0" | 7 LH Thread   |   |        | 75   | 144 | 18  | 1/2"      | 12'-9" | Do     |               |                                       |
| K36                        | a           | 1   | 8   | 1/2"      | 26'-6" | As bar K10 a but dimension x = 0'-10"                         |   |        | 76   | 144 | 18  | 1/2"      | 12'-9" | Do     |               |                                       |
|                            | b           | 1   | 8   | 1/2"      | 29'-0" | 7 LH Thread   |   |        | 77   | 144 | 18  | 1/2"      | 12'-9" | Do     |               |                                       |
| K37                        | a           | 1   | 8   | 1/2"      | 26'-6" | As bar K10 a but dimension x = 0'-10"                         |   |        | 78   | 144 | 18  | 1/2"      | 12'-9" | Do     |               |                                       |
|                            | b           | 1   | 8   | 1/2"      | 29'-0" | 7 LH Thread   |   |        | 79   | 144 | 18  | 1/2"      | 12'-9" | Do     |               |                                       |
| K38                        | a           | 1   | 8   | 1/2"      | 26'-6" | As bar K10 a but dimension x = 0'-10"                         |   |        | 80   | 144 | 18  | 1/2"      | 12'-9" | Do     |               |                                       |
|                            | b           | 1   | 8   | 1/2"      | 29'-0" | 7 LH Thread   |   |        | 81   | 144 | 18  | 1/2"      | 12'-9" | Do     |               |                                       |
| K39                        | a           | 1   | 8   | 1/2"      | 26'-6" | As bar K10 a but dimension x = 0'-10"                         |   |        | 82   | 144 | 18  | 1/2"      | 12'-9" | Do     |               |                                       |
|                            | b           | 1   | 8   | 1/2"      | 29'-0" | 7 LH Thread   |   |        | 83   | 144 | 18  | 1/2"      | 12'-9" | Do     |               |                                       |
| K40                        | a           | 1   | 8   | 1/2"      | 26'-6" | As bar K10 a but dimension x = 0'-10"                         |   |        | 84   | 144 | 18  | 1/2"      | 12'-9" | Do     |               |                                       |
|                            | b           | 1</ |     |           |        |   |   |        |      |     |     |           |        |        |               |                                       |



After experience of probably every method of detailing the writers are of opinion that it is better to show the outlines of the concrete in thin lines on the reinforcement details and the steel bars in single thick lines. Whilst the showing of bars by double lines is perhaps more accurate it is extremely laborious, and only in special cases is it of practical value in assisting either the facility or accuracy of carrying out the work.

In preparing a tracing it should be remembered that its purpose is to permit the production of clear and easily readable prints. The thinner outlines of the concrete work should be sufficiently thick to ensure a perfectly clear and continuous line on the prints. It is particularly necessary in reinforced concrete

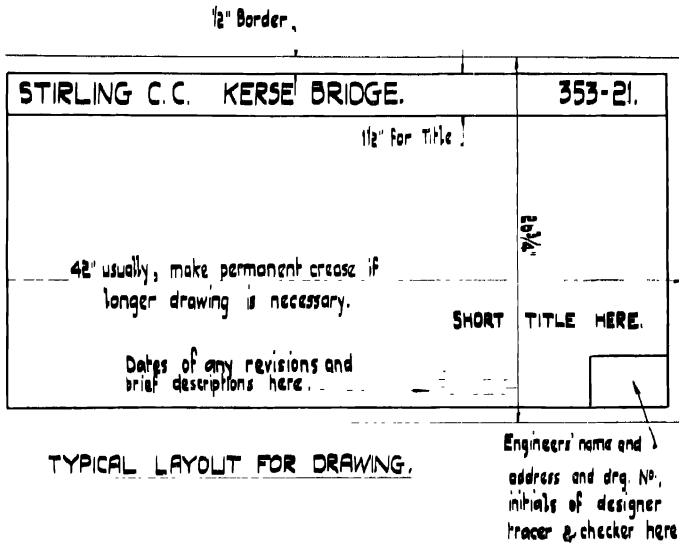
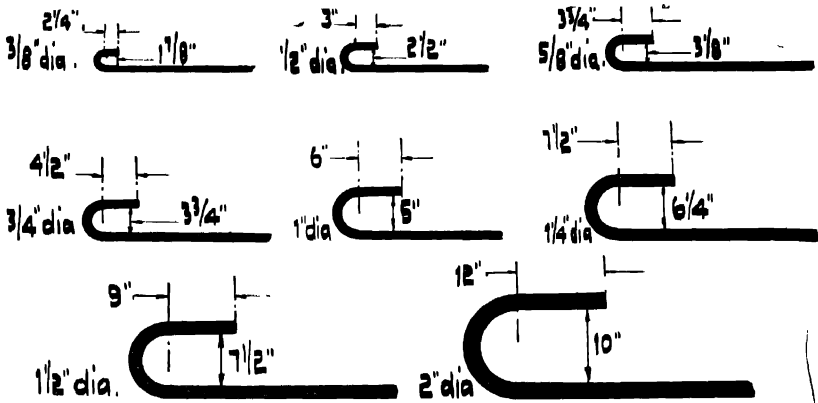

Fig. 233.

details, which at times are somewhat intricate, that the printing should be neat and clear, because the conditions on the site are particularly liable to obliterate the diagrams and printing. Unless, therefore, they are made very clear in the first instance they soon become unreadable.

The draughtsman should also cultivate the habit of drawing the hooks on bars to approximately their correct scale size. One sometimes sees reinforced concrete details on which hooks have been sketched to a uniform size throughout for bars varying in diameter from perhaps  $\frac{3}{8}$  in. to  $1\frac{1}{2}$  in. If this practice is adhered to, sooner or later the designer will find that he has drawn hooks on some of the larger diameter bars which it is quite impossible to get into the work at the site due probably to their overlapping adjacent hooks. Fig. 234 illustrates this point.



**DETAILS OF HOOKS.**

ACTUAL SIZES WHEN DRAWN TO SCALE OF 2 FT. TO 1 INCH.

NOTE VARIATION IN SIZE & THICKNESS.

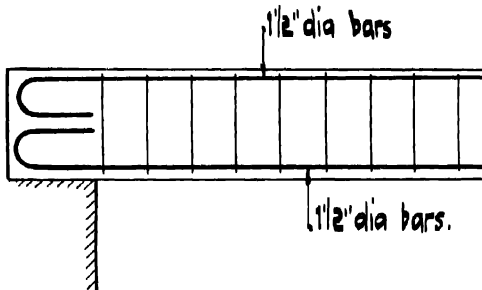

END OF BEAM AS SOMETIMES DETAILED.

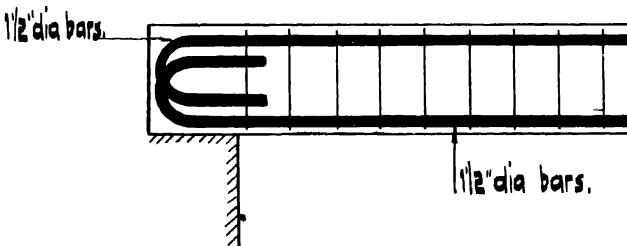

ACTUAL & AS IT APPEARS AT SITE,

(IMPRACTICABLE)

Fig. 234.

Every drawing made should be given a definite reference number. This ruling eliminates the use of subscript letters which frequently result in difficulty in recording, filing, and quick reference. It will usually be found advisable to include on each drawing a number of notes. The position, size, and type of these should be such that they will not be overlooked. Details are searched for on a drawing, but notes must make themselves seen.

### Calculations.

Details of the calculations necessary for practically every type of reinforced concrete bridge are given in other chapters, but there are certain general points in the preparation of the calculation sheets to which attention may well be given. In the first place it should be remembered that, whilst the designer making the calculations understands them, it will be extremely difficult for the checker and an engineer at a later date to follow them unless they are prepared in a clear and orderly manner. To this end they should be made throughout on sheets of a standard size. Ordinary quarto size paper is very suitable. A fairly wide margin should be included on the left-hand side of the sheet into which the final result of the calculations, such as the amount of steel found necessary, thickness of concrete in the case of slabs, overall dimensions in the case of beams, and sketches showing the arrangement of bars, may be included. Frequently it is necessary for these calculations to be submitted to different authorities, and in such cases it is a good plan to have them copied on a large sheet of tracing cloth ruled to quarto size. This not only helps to preserve the calculations but reduces the labour in printing as several sheets can be printed at one time and the prints cut up to give the quarto size sheets suggested. A typical first sheet of a set of calculations is given in *Fig. 235*. This sheet should be headed with the name and reference number of the work, the date on which the calculations are made, the name of the engineer making them, and the stresses and data to which he is working. These data should include the stresses allowed in the steel and in the concrete of various mixtures, the intensity of loading allowed on the ground; and similar general data which may affect the calculations.

The object of the general drawings is to show the finished work in every detail with the exception of the reinforcement. In some offices a practice has developed of showing plans of deck slabs with the beam arrangement as if one were looking from below. It has been found that whilst this is generally understood by engineers it often causes considerable confusion to the workmen at the site. It is better, therefore, to draw plans of this kind looking from the top with the outlines of the beams below shown dotted. This may take a little more time in tracing but the additional clearness of the drawings at the site makes this labour well worth while. These drawings should include full dimensions for setting out the structure and for the use of the joiners and general workers in carrying out their part of the construction. The depths of the foundation should be given as far as they can be settled in the office by the engineer, but to avoid misunderstanding at the site notes should be clearly shown adjacent to the various foundations stating that the ground must be approved by the engineer before concreting commences. In the same place a note might well be given stating that where soft ground or bad pockets are encountered these are to be taken out and filled with plain concrete as directed by the engineer.

REINFORCED CONCRETE BRIDGES

Under all reinforced concrete foundations a layer of blinding concrete should be shown placed directly on top of the ground. The thickness of this may vary from 2 in. to 4 in. according to the nature of the ground on which it is laid ; for most soils and purposes a thickness of 2 in. is sufficient. The mixtures of concrete in the various parts of the work should be classified under a general note given

| Ref. No.   | TITLE OF WORK.   | Date   |
|--|--|--|
|  | <u>ARCHITECTS OR ENGINEER'S NAME.</u>  | <u>Designer's Initials</u>   |
|  | <u>CALCULATIONS.</u>   | <u>Checker's Initials</u>  |
|  | Superload = 100 lbs. per sq. ft.   |  |
|  | Maximum allowable load on Foundations = 2 tons per sq. ft.   |  |
|  | Maximum allowable compressive stress on  |  |
|  | 1: 2: 4 concrete = 600 lbs. per sq. in.  |  |
|  | Maximum allowable tensile stress on steel = 16000 lbs. per sq. in.   |  |
|  | -----  |  |
| 5' Slab<br>3/8" φ at<br>6' cts.  | <p><u>SLAB.</u> Span 9'-0" <math>\frac{W.L.}{12}</math></p> <p>M = 160 lbs x 9<sup>2</sup> x 1 = 13000 in lbs.</p> <p>At = <math>\frac{13,000}{4.5 \times 14,100}</math> = .216 sq. in.</p>  | <p>Loading lbs</p> <p>Super = 100</p> <p>Slab = 60</p> <p style="text-align: right;"><u>160</u></p>                              |
|  <p>4 - 1" φ</p> | <p><u>SECONDARY BEAMS,</u> Span 20'-0" <math>\frac{W.L.}{12}</math></p> <p>M = 1540 lbs x 20<sup>2</sup> x 1 = 616,000 in. lbs.</p> <p>At = <math>\frac{616,000}{15 \times 14,100}</math> = 2.9 sq. in.</p> <p>S = 1540 lbs x 10 = 15,400 lbs</p> <p>S = <math>\frac{15,400}{15 \times 7}</math> = 146 lbs. per sq. in.</p> <p>3/8" dia. links 2 branches at 3' to 3' pitch.</p> | <p>Loading lbs</p> <p>From Slab = 160 x 9 = 1440</p> <p>From Rib = 100</p> <p style="text-align: right;"><u>1540 per ft.</u></p> |

Fig. 235.

prominently on the drawing. The cover to be given to the reinforcement in each part of the work should also be shown on these general drawings and should be included also on the reinforcement details prepared later for the use of the steel benders and fixers.

Considerable improvement in the quality of reinforced concrete structures



would result if stopping-off planes in the concrete could be definitely arranged by the engineer and shown on his drawings, because in every case the stopping-off planes could then be located in positions where they would not seriously affect the strength of the work and where so far as possible they would not be evident in the finished structure. The difficulty in arranging for this, however, lies in the fact that until the contract is placed and the contractor's programme of construction is disclosed the engineer is not aware of the size or number of mixers to be used nor of the quantity of concrete likely to be placed in one day. Without this information it is difficult to arrange stopping-off planes. The engineer may, however, insist on the position of such planes being at the springing of an arch or at the junction of the base and stem of a retaining wall, and these should be shown on the general drawings. Details of other features such as expansion joints and their method of construction and filling, notes on the surface finish to be given to the walls, provisions for possible extension to the work, etc., should also be shown. Where the parapet of the bridge is of precast baluster construction a full-size detail of the baluster is advisable; not only does this show the shape clearly to the contractor but it is an advantage to the engineer in enabling him to decide whether the shape chosen is the most suitable and pleasing for the work.

#### **Detailing of Reinforcement.**

The detailing of the reinforcement forms possibly the most arduous part of the drawing office work in connection with a reinforced concrete bridge scheme, for on these drawings the position and details of the bending of every rod, link, binder, and helix should be clearly shown so that the steel benders and fixers have complete instructions with regard to their portion of the work. This entails the preparation of a skeleton elevation and plan and cross-sections for each separate member of the structure. In the case of beams there is frequently a doubt whether it is necessary to give several cross-sections of the beam to show the reinforcement in the various positions. The experience of the writers is that in practically every case a cross-section at the centre is sufficient, although in particularly complicated girders it may be necessary to include cross-sections at other parts.

Before proceeding to describe the various arrangements of reinforcement, it is desirable to include some particulars in regard to the steel itself. This is purchased ex mill, that is, from the manufacturers, or ex stock, that is, from a merchant who keeps on his premises quantities of bars of each diameter used in reinforced concrete work. The rolling mills usually work to programmes arranged for about one week ahead, commencing as a rule with the larger diameters and working through to the smaller sizes. For example, a mill might commence rolling 1½-in. diameter material on Monday, continue rolling decreasing sizes, and perhaps finish on ½-in. bars towards the end of the week. If, however, the orders do not include sufficient material of some of the sizes the rolls for these may not be put in and this may mean a considerable delay in obtaining the particular size from that mill. It is therefore important to use the minimum number of different diameters of bar in any bridge. In addition the price for ½-in. diameter bars is taken as the basis for rolled round bars, and an increased charge per ton is made for each diameter smaller than this. Occasionally in

preparing detail drawings smaller diameters than those allowed in the estimate of the work are used, and in consequence it must be kept in mind that such reinforcement may be charged at a higher rate. A watch must also be kept on the lengths of bars used in the work. Most mills supply in lengths of 30 ft. without extra charge, but over this length they have a standard list of extra charges. It is therefore desirable wherever possible to use bars not longer than 30 ft. Further, by using bars under this length it is frequently possible to obtain the material more quickly. Another factor in regard to the length is that of

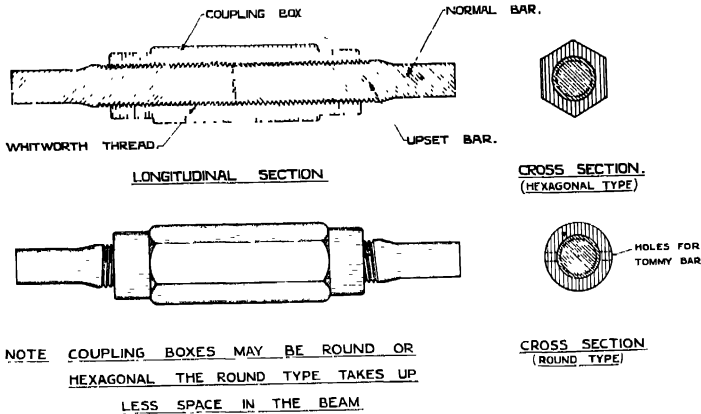

Fig. 236.

transport. An ordinary railway wagon will take material 18 ft. long and in consequence quantities of material up to this length and up to one ton in weight are charged a full one-ton carriage. For every 18 ft. or part of 18 ft. additional

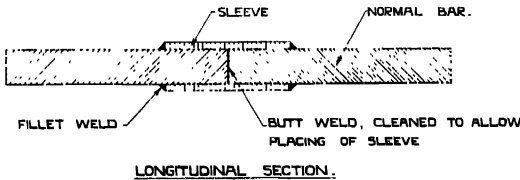
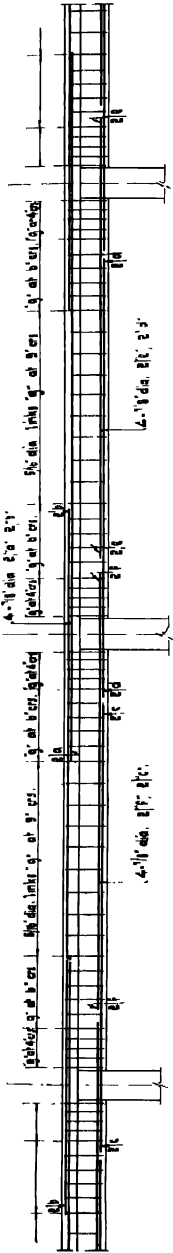

Fig. 237.

length, each ton or part of a ton is charged as one ton additional carriage. For exceptionally long bars, say 50 ft. and upwards, special wagons are required for which special charges are made. It is therefore advisable to use long length bars only when sufficient is required to warrant the additional carriage. Further difficulty arises here in that it is sometimes necessary to wait until a special wagon is available for exceptionally long lengths, and this may cause delay in the work unless ample time is allowed.

It is obvious that where a merchant carries a stock of reinforcing bars he



DETAIL OF BEAM USING STRAIGHT BARS ONLY.

Fig. 238.

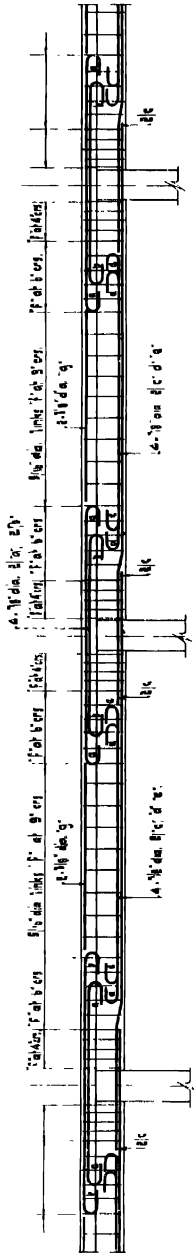

DETAIL OF BEAM USING HOOKED & CRANKED BARS.

Fig. 239.

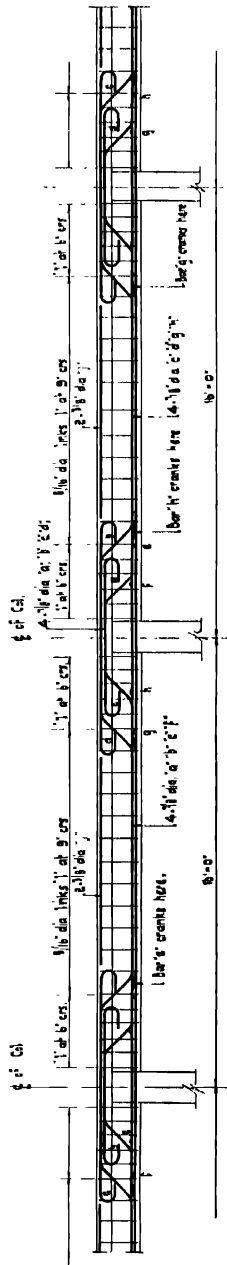

DETAIL OF BEAM USING BENT-UP BARS

Fig. 240.

requires remuneration for his outlay on the material, for the additional handling in taking it into his yard and delivering it to the site, for loss in cutting to lengths required, and so on. In consequence stock material should be purchased only when extreme urgency necessitates immediate delivery, and throughout the preparation of the design and the issue of the schedule ample time should be allowed to permit the contractor to obtain the material on ex mill terms.

With regard to stirrups, links, and binders, frequent changes in the size of these necessitate a fresh setting up of the machine on which they are manufactured and this increases the cost. Designers should therefore endeavour to use as few sizes as possible.

Where only very few lengths of exceptionally long bars are required the designer should keep in mind that it is possible to use coupling boxes to join two shorter lengths of bars to produce the necessary total length at the site. A sketch of a coupling box is given in *Fig. 236*. Another method of joining bars to obtain longer lengths is butt welding; for further security a sleeve of steel may be slipped over the butt weld and the sleeve welded to the bars at both ends, as is shown in *Fig. 237*.

In beams and slabs three different arrangements of main reinforcement may be used. The bars may be in straight lengths with sufficient steel allowed at the laps to develop their strength (*Fig. 238*). This method has been used with success, but it is doubtful whether the joint is really so satisfactory as an arrangement in which the bars are hooked at the end; there may, however, be cases in which its facility of assembly may warrant its adoption.

The second type of reinforcement is that using bars having hooks at both ends but otherwise being straight and resisting the whole of the shear in the member by means of stirrups or links (*Fig. 239*). This arrangement has the advantage of simplicity in bending and assembling, but in cases where the shear is high it necessitates a very close spacing of the stirrups which makes the placing and ramming of the concrete a little more difficult.

The third method is to use turned-up or cranked bars as shown in *Fig. 240*. In this case at least a third of the main reinforcement should be carried through to the support of the beams; the remaining two-thirds may be carried up in suitable positions to assist in resisting the shear in the member. The upper horizontal portion forms part of the reinforcement over the supports of the beam. This is the arrangement usually adopted. It is more economical in steel than either of the other methods, and in addition reduces the number of stirrups and to some degree the labour of assembly.

Stirrups are usually formed in one of the four ways shown in *Fig. 241*. In the first case the stirrups consist of a straight length of the necessary diameter of bar, usually from  $\frac{1}{4}$  in. to  $\frac{1}{2}$  in., depending on the amount of shear to be resisted, bent to a rectangle to fit round two of the top bars and two of the bottom bars in the beam. The end of the bar from which the stirrup is made is bent sharply round one of the reinforcing rods, usually one of the top rods, for ease in assembly. In the second case the stirrup is formed from one length of rod and the main reinforcing bars are fitted into the bends in the positions indicated. This type of stirrup has the advantage of providing a greater amount of steel to resist shear, and it also perhaps gives rather better anchorage at both top and bottom of the beam than the first type shown. It is generally used in conjunction with

straight bars or with bars hooked at the end. The general opinion among steel fixers, however, is that this type of stirrup is more difficult to assemble than the first type.

The third type of stirrup consists simply of a U with a similar bar inverted. This is not used except in cases where it would be difficult to adopt one of the two previously mentioned types. In very complicated beams, however, this type has an appreciable advantage as it permits the bars in the top and bottom of the beam being placed in position without first having to slip all the stirrups over them. Where this type of stirrup is used sufficient lap should be given to the open ends of the U fully to develop the strength of the stirrups.

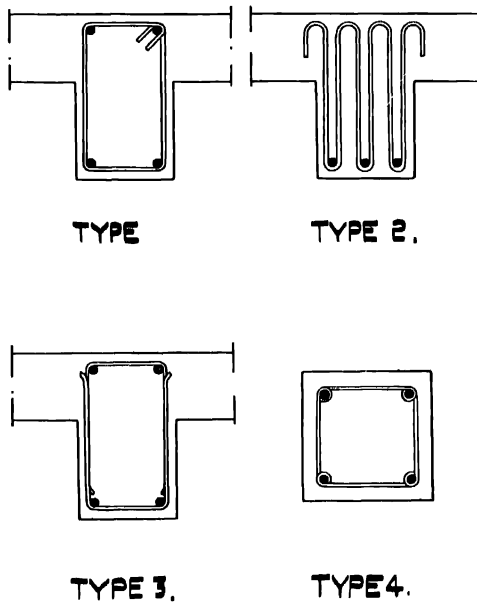
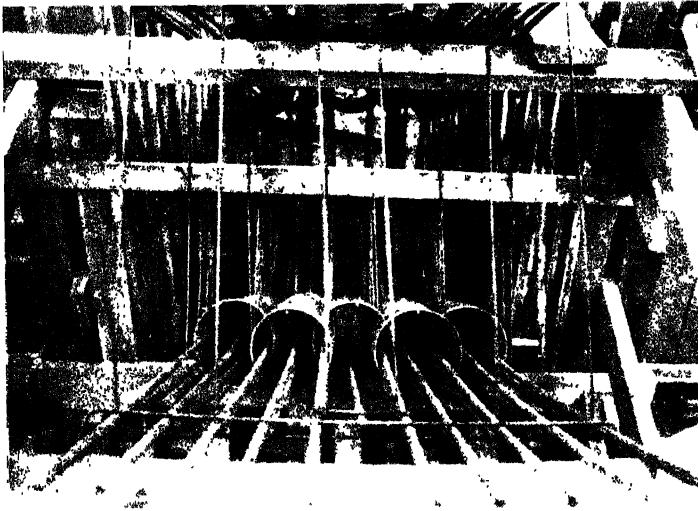

Fig. 241.

The fourth type of stirrup is that in which the rod is twisted round to encircle entirely each bar lying at its corner. The object here is to ensure that the bars will be properly spaced in the member. It is more frequently used for columns than for beams. Our experience is that it does not fulfil its object any better than the first type of stirrup described, for the following reasons. Due to the fact that reinforcing bars are burred slightly at the ends when they are cut, if this type of stirrup is adopted it is necessary to make the encircling portions at the corner appreciably greater than the diameter of the bar in order that it may slip easily over the burred end. This rather detracts from its accuracy in spacing the bars in the member, as the increase in the size of the loop leaves room for appreciable lateral movement of the bar. The second disadvantage is that it is almost impossible to assemble this type in a member when both ends of the bars are hooked. It is also more expensive to manufacture.

In addition to the ordinary type of rectangular binder in columns and arch ribs helical reinforcement consisting of bars from  $\frac{1}{4}$  in. to  $\frac{1}{2}$  in. diameter is frequently used in long lengths wound to a helix of calculated pitch. In the case of arch ribs these helices are frequently interlocked as in the case of the bridge arch ribs illustrated in *Fig. 148* which shows a diagrammatic section of the arch rib, a photograph of which (*Fig. 242*) shows the interlocking helices.

Details of the reinforcement should also give clearly the spacing between the bars both horizontally and vertically. The vertical spacing between layers of reinforcement in beams may be effected in practice by introducing short lengths of bar of the necessary diameter, and where the designer wishes this method to be adopted he may include in his details for a number of such short bars. These features are indicated in *Fig. 244*.

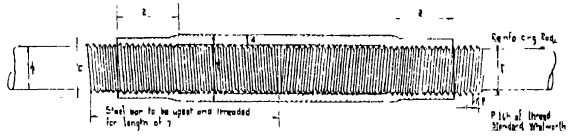

**Fig. 242.**

In addition to the elevations and the sections of the members, the details of the reinforcement should also include a bending schedule in which every bar is drawn out diagrammatically and is dimensioned to show the length and arrangement of the various bends. A typical arrangement for one of these bending schedules is given below :

| MEMBER       |       | Reference letter | BARS            |                 |                          |                 |
|--------------|-------|------------------|-----------------|-----------------|--------------------------|-----------------|
| Reference No | No of |                  | Diameter of bar | No of each type | Total length of each bar | Bending diagram |
|              |       |                  |                 |                 |                          |                 |

| OAD | REMARKS                              |
|-----|--------------------------------------|
| 0   | Bottom rods bottom layer             |
| 0   | Do                                   |
| 10  | Bottom bars 2 <sup>nd</sup> layer    |
| 10  | Bottom bars 2 <sup>nd</sup> layer    |
| 5   | Bottom bars 3 <sup>rd</sup> layer    |
| 5   | Bottom bars 3 <sup>rd</sup> layer    |
| 10  | Top bars                             |
| 10  | Top bars                             |
| 0   | Do                                   |
| 0   | Do                                   |
| 10  | Do                                   |
| 10  | Top bars 2 <sup>nd</sup> layer       |
| 0   | Do                                   |
| 0   | Do                                   |
| 10  | Top bars 1 <sup>st</sup> layer       |
| 0   | Do                                   |
| 0   | Do                                   |
| 10  | Top bars 2 <sup>nd</sup> layer       |
| 0   | Do                                   |
| 0   | Do                                   |
| 10  | Top bars 1 <sup>st</sup> layer       |
| 0   | Do                                   |
| 0   | Do                                   |
| 10  | Top bars 2 <sup>nd</sup> layer       |
| 0   | Do                                   |
| 0   | Do                                   |
| 10  | Links of 8 & 12 crs                  |
| 10  | Links of 15 crs                      |
| 10  | Links of 24 crs                      |
| 10  | Links of 24 crs                      |
| 10  | Links of 24 crs                      |
| 10  | Links of 18 crs                      |
| 10  | Links of 18 crs                      |
| 10  | Links of 24 crs                      |
| 10  | Inverted links of 8, 12, 15 & 24 crs |
| 10  | Do Do of 18 crs                      |
| 10  | Do Do of 24 crs                      |
| 10  | Do Do of 24 crs                      |



HALF FULL SIZE DETAIL OF SCREW COUPLING.

| BEAM NUMBER | N <sup>o</sup> OF COUPLINGS | DIAM OF BAR φ | l      | T      | C      | F    | d    | REMARKS   |
|-------------|-----------------------------|---------------|--------|--------|--------|------|------|-----------|
| 10          | 7                           | 1 1/2"        | 1 3/4" | 2 1/2" | 2 1/4" | 1/5" | 3/8" | STANDARD  |
| 11          | 7                           | 1 1/2"        | 1 3/4" | 2 1/2" | 2 1/4" | 1/5" | 3/8" | WHITWORTH |
| 12          | 7                           | 1 1/2"        | 1 3/4" | 2 1/2" | 2 1/4" | 1/5" | 3/8" | THREADS   |
| 13          | 7                           | 1 1/2"        | 1 3/4" | 2 1/2" | 2 1/4" | 1/5" | 3/8" |           |

COUNTY OF KINCARDINE.

INVERBERVIE BRIDGE.

SCHEDULES OF STEEL REINFORCEMENT.

FOR BEAMS 10, 11, 12 & 13.

FOR DETAILS OF ABOVE BEAMS SEE WKG. DRG. 363-40.

DAVID J. BELL C E  
COUNTY ENGINEER - STONEHAVEN

F A MACDONALD & PARTNERS  
135 WELLSINGTON STREET, GLASGOW

WKG DRAWING NO. - 363-41

DRAWN BY [Signature] CHECKED BY [Signature]  
TRACED BY [Signature] 3/4/31 APPROVED BY [Signature]





There are different opinions on whether these bending schedules should appear on the drawings or be separate documents. Generally it is better to include them on the drawing as this saves the designer's time and is more convenient for the contractor's use at the site. Further, if these bending schedules are placed along the sides of the drawings it is easy to cut them off or to have only those portions of the drawings printed should additional copies of the bending schedule only be required. When they are included on the drawing it is easier to cross-reference the bars from drawings to schedule and vice versa when referring to the details at the site than is the case if one has to handle two sheets. Immediately above or below the bending schedule should be given a double-line diagram of a typical reinforcement bar showing exactly the points to which the dimensions given in the bending schedule are taken. A typical schedule of this kind is given in *Fig. 243*. The dimensions shown thereon are the most suitable for use on the site by the steel fixer. Generally speaking one should give overall dimensions so that the fixer can use the actual measurements rather than be

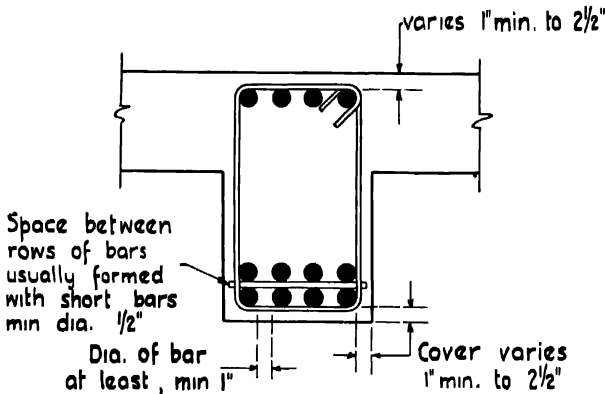

**Fig. 244.**—Sketch showing Minimum Covers required.

compelled to add or deduct the thickness of the bars as occurs when centre-line dimensions are given. Where a dimension for a hook is given it is usually intended as an allowance for forming the hook over and above the total dimension given for the overall length.

For hooks there are standard sizes, but those recommended by the writers are given in *Fig. 245*. These sizes are not fixed arbitrarily but ensure that the pressure on the concrete inside the hook does not exceed a stated value.

On the bending schedule the dimensions along the length of bars should be given to the nearest inch. Cranking dimensions should be given to the nearest half-inch. In practice it is not reasonable to expect the steel bender and fixer to work to closer accuracy than this.

On the skeleton elevations it will be a great advantage to letter the bars at each end rather than at some point along their length. By adopting this arrangement the length of a bar which overlaps several others in the elevation is clearly indicated, and it is possible when reading the drawing to trace the

bar from end to end in comparing it with the diagram given in the bending schedule.

On plans hooks on bars are usually indicated by short ticks at the end of the bars. In the case of top bars it is a good plan to show the ticks on the lower side of the bar when looking at the drawing, the ticks on the bottom bars being on the upper side. In the case of bars parallel to the side of the drawing the ticks should be placed on the right-hand side for the top bars, and on the left-hand side for bottom bars. This notation materially assists those called on to interpret the drawing (see *Fig. 245*).

The numbers and reference letters of bars in the elevations should be distributed and not crowded into any one part of the detail of each unit. Such crowding gives the drawing a bad appearance and makes it difficult to read.

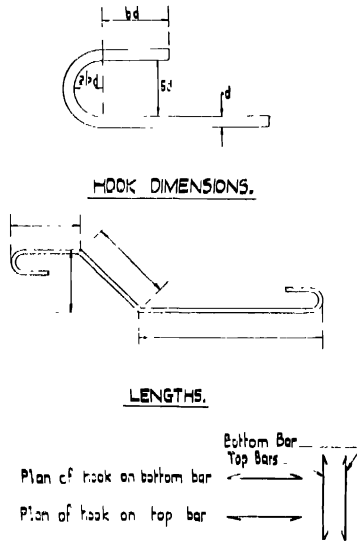
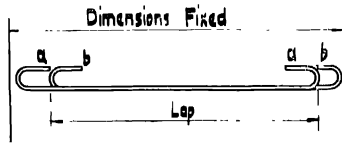

Fig. 245.

Throughout the whole of the detailing the designer should bear in mind that the steel fixer will ultimately be called on to assemble the bars shown on his drawing. The designer works on one plane only, whilst the steel fixer has the whole width of the beam to work in. Unless, therefore, care is taken, a designer may develop an arrangement of steel which is almost impossible to assemble in the work. The points requiring particular attention are where hooks occur close together in beams and tend to overlap and where bars overlap each other. In considering the question of hooks it should be remembered that very frequently a hook is not bent in exactly the same plane as the main length of bar and when it is placed in the work the hook does not lie directly over the main bar. In consequence it is always best to assume that a hook takes up in the width of a beam at least  $2\frac{1}{2}$  times the diameter of the bar. If this is done it will usually be possible, even where hooks are not bent in the same plane, to

twist them into their correct position. Where there is insufficient width in beams to arrange lapped bars side by side, it may be necessary to crank one up above the other. In this case it should be remembered that the bars which lie in the bottom layer cannot be provided with hooks when other bars are to be placed over them. An example occurs where the bottom bars of a continuous beam overlap at the column. This is a position which always calls for special attention if an easy assembly is to be provided at the site. Another case requiring care is that where both ends of a bar are rigidly fixed by concrete dimensions or some other circumstance. It is advisable if possible to arrange the bars so that they do not extend from end to end but are spliced at some point to give a little latitude for dimensions at the site which are not in absolute accordance with the drawings (*Fig. 246*). Where this is impossible a special note should



**Fig. 246.- Method of arranging Bars to split a Fixed Dimension.**

be made that such bars are to be of exact length. Failing such a note rolling mills usually supply to within plus or minus 1 in. of the length stated, and the bending at the site is not usually more accurate than one inch more or less than the overall lengths given.

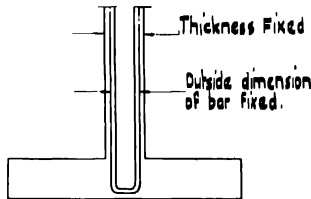

**Fig. 247. Fixed Cover to Bars.**

In the design of reinforced concrete members it is frequently possible to arrange the bending of bars in such a way as almost to ensure that the reinforcement will be given its correct cover. A simple instance of this is the case of retaining walls where, if the splice bars from the base slab into the stem are formed to a U shape so that they will fit with one leg of the U along the front and the other along the back of the wall, the correct cover on both sides will be ensured. Where this is adopted, however, care should be taken that the bending dimensions given are not too "tight" (*Fig. 247*).

Distribution bars or temperature steel should wherever possible have the laps staggered. This is particularly desirable in cases where distribution bars are likely also to deal with a certain amount of tension due to bending, or where there is a possibility of fairly high stress developing in a long length of wall or deck slab due to expansion. If the laps are staggered there is much more

likelihood of obtaining a uniform strength in the structure against the forces which may develop than if all the laps are placed in one line across the member.

Another point requiring attention occurs in retaining walls, portal frames, and similar structures. The base slabs of these are frequently comparatively thin, and do not form sufficiently deep anchorage for bars which extend a considerable height above. In such cases short lengths of bars should be used as splice bars to allow of the longer vertical bars being assembled after the foundation has hardened and when it is possible to arrange more conveniently for lateral support at the higher levels.

In addition to arranging the reinforcement to meet the calculated stresses it should be kept in mind that there are certain secondary, or one might even call them tertiary, stresses which it is quite impossible to calculate. This is not a difficulty inherent only in reinforced concrete construction, but occurs in every type of constructional material. As an example, such a case occurs in the detailing of corner junctions of cantilever retaining walls; whilst the main reinforcement against cantilever action will be vertical, a certain amount of

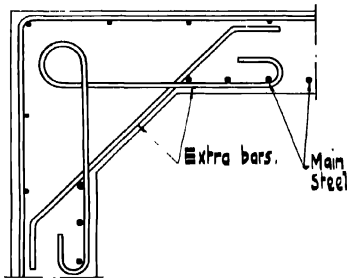

Fig. 248. —Plan of Corner showing Extra Steel required.

horizontal reinforcement should be included in the angle to deal with stresses developing as a result of the wall spanning as a monolithic member round the junction (*Fig. 248*). Another case occurs in a bridge parapet which is made monolithic with the structural reinforced concrete girder below but which is not designed to act as a part of that girder. This is a form of design which should be avoided wherever possible, for obviously if the parapet is rigidly attached to the girder below it must attempt to work with it, and in consequence cracks frequently appear in such members. Such cracks can, however, be avoided by including in the detail design a reasonable amount of reinforcement to counteract them. Another and wiser precaution is to provide vertical joints at frequent intervals in such a parapet so as to reduce its monolithic character.

Reinforcement placed at the junction of vertical and horizontal members should never be brought down from the horizontal member for even a short distance into the vertical members. Instead, the reinforcement of the vertical members should always be turned into the horizontal member. An example of this occurs at the corner of a rectangular frame consisting of two columns and a horizontal cross-beam. Due to the fact that the columns are usually concreted to the underside of the beam before the beam reinforcement and shut-

tering are placed it is obviously unwise for the beam bars to project down into the column. It would be most inconvenient to fix the steel in this position; it would in fact almost necessitate the assembly of sluttering and reinforcement for both column and cross-beam in one operation (*Fig. 249*).

Throughout the detailing of the reinforcement the designer should keep in mind the site conditions. As a typical case of this one may consider the placing of reinforcement in deep excavations. Generally these necessitate considerable timbering and cross-strutting at close centres. In such an excavation it is obviously difficult to handle bars of long lengths, and they should be kept as short as possible. Where bars are to lie across such an excavation it is always more convenient to have them in two lengths overlapping to permit

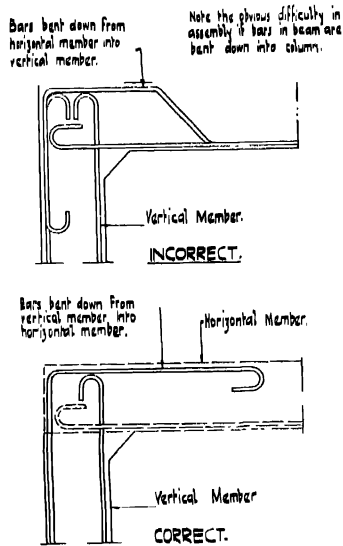

**Fig. 249.**—Arrangement of Bars at Junction of Vertical and Horizontal Member.

easy assembly and adjustment, and the design of most retaining walls will permit this arrangement.

It has been found from experience that where large columns support comparatively thin deck slabs there is a tendency for the slab to crack between the beam junctions. In order to counteract this tendency it is a good plan to arrange for pairs of bars, say  $\frac{3}{8}$  in. to  $\frac{3}{4}$  in. diameter, depending on the heaviness of the work, to be laid in the slab diagonally to the lines of the beams joining on to such column supports, as shown in *Fig. 250*.

The cover to be allowed to reinforcement bars is open to question. It may be said, however, that for internal work the absolute minimum cover permissible is  $\frac{1}{2}$  in. for small bars. For external work for walls and deck slabs the minimum cover should be  $\frac{3}{4}$  in. and for preference 1 in.; for larger members a cover of  $1\frac{1}{2}$  in. to 2 in. is desirable. In this connection it is usual to specify the cover to

the main reinforcement, and where the shear reinforcement is particularly large care should be taken to ensure that even if this is placed on the outside of the main reinforcement there will still be ample net cover in the finished work.

The cover given to the bars in the bottom of the foundations should always be defined as the "net cover" of reinforced concrete measured from the top of the blinding over the ground.

It is unwise to state on a drawing that the cover to bars is to be a "minimum," because if, for example, the cover of a slab is given as " $\frac{1}{2}$ -in. minimum" a workman might make the cover 1 in. or 2 in. and think that by doing so he was improving the work, whilst as a matter of fact he might be endangering it.

Where there is to be a very large amount of repetition in an assembly [of

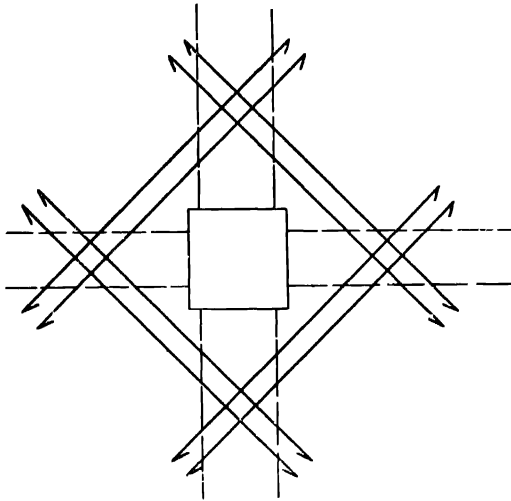

Fig. 250. Sketch showing Diagonal Bars around Column Head.

reinforcement, as for example in a long length of retaining wall or in the width of a wide arch ring, it is wise to add a note to the drawings that the assembly of the reinforcement in accordance with the bending dimensions given is to be checked to full size on the work after the first frame is prepared, and before the repetition work is put in hand. This permits of small adjustments being made to facilitate assembly, the need for which may not have been foreseen when the details were prepared. A check such as this frequently avoids the considerable annoyance of making very minor adjustments to a large number of reinforcing bars.

Blue prints are generally supplied of the reinforcement details. It is a great advantage to supply a set of these on linen to the clerk of works, but there is a doubt of the desirability of supplying linen prints to the contractor. The experience of the writers is that it is better to supply paper prints and to renew them as necessary throughout the construction. Linen prints do not wear

well under the conditions existing on reinforced concrete work. They are comparatively expensive, and the additional money expended on them will often be spent to better advantage if a larger number of paper copies are supplied.

### Checking.

The design of reinforced concrete work is comparatively so intricate that it is essential that all drawings before final issue to the site shall be thoroughly and independently checked. In some cases this is done while the drawings are in the pencil stage, but this tends to permit tracing errors to reach the site. It is better that the drawings be completed and traced and ready for use before they are passed to the checkers for examination. In this connection it should be noted that tracers should be made entirely responsible for ensuring that their tracings are in exact accordance with the designer's paper drawing. It is work which tracers can quite well do for themselves and so save the more valuable time of the designer.

On acceptance of a drawing for checking the first duty of the checker should be to make a general survey of the drawing with a view to noting whether there are any outstanding points contrary to good practice. Such things as wrongly proportioned retaining walls, bad arrangements of reinforcement, obviously little reinforcement in important members, and similar matters should be noted by an experienced checker in this general survey, whereas if he does not make the general survey he is liable to become immersed in the intricate details of the drawing with the risk of overlooking such evident errors. Having made a general survey the next step is to compare the reinforced concrete drawings with the particulars which have been supplied by the client and by any sub-contractors for work which joins up with the reinforced concrete work and to ensure that everything is in agreement. After this he should go over the whole of the general dimensions given for the work and verify that they are correct; that intermediate dimensions total correctly to over-all dimensions; and that the over-all dimensions agree with those required by the client's particulars or by the survey of the site.

Next the checker should go over the detail points of construction and verify that items such as weep holes in retaining walls, proofing, expansion joints, etc., have not been overlooked. He should then make very approximate calculations of the amount of reinforcement required in each of the main members to ensure that there is no serious discrepancy in this important part of the work. Having made approximate calculations he should look over the arrangement of reinforcement and verify that it is in accordance with the bending moments, shear, and other stresses as more accurately calculated by the designer. Finally he should go over the whole of the dimensions in the bending schedule and verify that they are in accordance with the detail drawings and the requirements of the work. He should also total up the bending dimensions given on each bending diagram and verify that the total length of each bar is correct. The number of bars given in the bending schedule against each reference letter, and the "number of members off" to each detail, should also be checked.

Throughout the whole of the checking red and yellow crayons should be used, everything which is correct being marked in yellow and everything which requires correction being marked in red. On completion of his work the checker

should see the designer, discuss with him the various corrections required and any other points which may arise, afterwards passing the drawing back to the designer for alteration. When such drawings are returned to the designer they should be corrected as quickly as possible whilst the particulars are fresh in the minds of both parties, and after correction they should be passed back again to the checker so that he may look quickly over them to ensure that the corrections have been carried out in accordance with his intentions.

Occasionally owing to the urgency of the work it is necessary to issue drawings before they are checked. In every case such drawings should be marked in large letters "Unchecked." If this is done the contractor receives immediately useful information to enable him to proceed with the work pending delivery of the final drawings and it allows the office sufficient time for checking.

When revision is required to a drawing which has already been issued to the site a print should be taken off the original drawing and marked "Superseded" and included in the office file; the date on which it was taken should be added together with any special note likely to be of future use to the engineer. This is important as occasionally disputes arise later in the work, and particularly during the settlement of the final measurements, on what were the actual instructions in force at any specific date.

It is particularly important that, when emendments are made to a scheme during construction necessitating alterations to the drawings, these alterations should be traced back through the whole of the drawings so that the necessary corrections are made throughout. Omission to do this is liable to lead to work being incorrectly built with consequent dissatisfaction and additional expense.

Finally it is extremely important that such alterations should themselves be checked before the revised drawings are issued from the office. There is probably no part of the work connected with the design of reinforced concrete so liable to errors of omission as the making of revisions to drawings already completed.

So far as the steel sheets are concerned the checking of these should be arranged for by the designer, as noted later, as they do not come within the province of the checker of the design drawings.

The following are a few further general notes collected from experience of the design of reinforced concrete work.

Occasionally work on a structure is divided between two or more designers. In such a case it is essential that particular care be taken to ensure that nothing is omitted at the junction of the work of the different designers and that there is no overlapping.

Designers should return plans to file immediately they have finished with them. If this is not done it is extremely difficult for another member of the staff to refer to documents and particulars as quickly as he could otherwise do, and in addition there is greater risk of drawings and documents being misplaced.

Occasionally there may be an advantage in taking prints from the pencil details and despatching preliminary copies to the site in order to enable the work to proceed before the pencil drawing is traced. In such case the pencil drawing should be traced as quickly as possible after the preliminary prints have been dispatched, and final prints should be sent forward. This avoids



pencil drawings being damaged and possibly being made indistinct before the tracing is carried out, and also permits of properly checked copies being issued at an early date.

When a number of prints is sent in an envelope each print should be folded separately. The practice of folding a number of prints together results in serious creasing.

To facilitate the keeping of the files in order it is a good plan to have the desks of the drawing office cleared completely at regular intervals. In some cases this is done daily, when all books, papers, drawings, etc., are placed into their correct receptacles before the staff leaves. In other cases it is sufficient to arrange for this to be done once a week and in some cases even once a month. This practice also results in temporarily misplaced drawings and documents being found, to the convenience of all concerned.

### Steel Sheets.

It is the practice of some offices to leave to the contractor the work of preparing steel sheets for ordering materials from mills or merchants, but in the opinion of the writers this is the engineer's duty. Owing to the regulations of railway and transport authorities it is generally cheaper to arrange for the despatch of as much material as possible in each consignment, and this should be remembered in issuing steel sheets or requisition sheets; in addition, the designer should keep in mind the part of the work for which the reinforcement is immediately required. Steel sheets are usually set out as follows:

| Diameter of bar | No. of bars thus | Length of bars | Weight per unit of length | Total weight | Remarks |
|-----------------|------------------|----------------|---------------------------|--------------|---------|
|-----------------|------------------|----------------|---------------------------|--------------|---------|

The information for these columns is abstracted from the bending schedule by ruling a piece of paper into a number of columns, one for each of the diameters of bar to be used. The "taker-off" then goes through the bending schedule and enters on this piece of paper the number of bars and length of bar from each item in the bending schedule. Having gone completely through the schedule referring to the part of work for which he is taking off the steel from the list he has obtained he then makes a list of the bars required in descending order of diameter and descending order of length. The total length of bars of each diameter is then worked out and multiplied by the weight per unit length and so the total weight of each diameter is obtained. When the steel list is completed a summary is made showing the different diameters and total weight of each diameter and the total weight of the whole list. *Figs. 251 and 252* show a typical schedule and the taking-off sheets. These steel sheets should be made out with several copies, for as a rule the engineer will require one for his records, the clerk of works will require one, the contractor will require one for use on the site and one for his own records, and one will be wanted for use in the mills, making five copies in all.

## SCHEDULE OF STEEL REINFORCEMENT

| BEAM                             | NO THIS | BAR | NO | TOTAL NO | DIAM   | LENGTH | BENDING  | REMARKS   |
|----------------------------------|---------|-----|----|----------|--------|--------|--|---|
| BEAM 21 Or Inner Curve of Bridge |         | a   | 3  | 3        | 1 1/8" | 59'-0" |  | * Bottom bars, bottom layer                       |
|                                  |         | b   | 3  | 3        | "      | 10'-0" |  | ** Do do  |
|                                  |         | c   | 2  | 2        | "      | 65'-0" |  | Do 2nd layer                                      |
|                                  |         | d   | 1  | 1        | "      | 65'-6" |  | Do do   |
|                                  |         | e   | 2  | 2        | 1 1/8" | 52'-6" |  | Do 3rd layer                                      |
|                                  |         | f   | 1  | 1        | 1 1/2" | 27'-6" |  | Bottom bars, in gusses!                           |
|                                  |         | g   | 2  | 2        | "      | 32'-6" |  | Do do   |
|                                  |         | h   | 2  | 2        | "      | 47'-0" |  | * Top bars, top layer                             |
|                                  |         | j   | 2  | 2        | "      | 31'-6" |  | * Do do   |
|                                  |         | k   | 1  | 1        | "      | 34'-3" |  | * Do do   |
|                                  |         | l   | 1  | 1        | "      | 53'-3" |  | * Do do   |
|                                  |         | m   | 2  | 2        | 1 1/2" | 52'-6" |  | Do do   |
|                                  |         | n   | 1  | 1        | 1 1/8" | 48'-6" |  | Do 2nd layer                                      |
|                                  |         | p   | 1  | 1        | "      | 55'-0" |  | Do do   |
|                                  |         | q   | 1  | 1        | "      | 45'-6" |  | Top bars, 2nd layer                               |
|                                  |         | r   | 1  | 1        | "      | 37'-0" |  | Do 3rd layer                                      |
|                                  |         | s   | 1  | 1        | "      | 29'-6" |  | Do do   |
|                                  |         | t   | 1  | 1        | 1 3/8" | 25'-6" |  | Top bars, 3rd layer                               |
|                                  |         | u   | 24 | 24       | 1/2"   | 14'-0" |  | Vertical links in pairs at 8', 12', 16' & 24' c/s |
|                                  |         | v   | 20 | 20       | 3/16"  | 14'-0" |  |   |
|                                  |         | w   | 12 | 12       | 3/8"   | 14'-0" |  |   |
|                                  |         | x   | 6  | 6        | 5/16"  | 14'-0" |  | Vertical links in pairs at 24' c/s.               |
|                                  |         | y   | 2  | 2        | 1/2"   | 14'-6" |  |   |
|                                  |         |     | 2  | 2        |        | 15'-6" |  |   |
|                                  |         |     | 2  | 2        |        | 16'-6" |  |   |
|                                  |         | z   | 2  | 2        | 1/2"   | 17'-6" |  |   |
|                                  | 2       |     | 2  | 18'-6"   |        |        |  |   |
|                                  | 2       |     | 2  | 19'-0"   |        |        |  |   |
|                                  | A       | 2   | 2  | 1/2"     | 19'-6" |        | Vertical links in pairs at 12' c/s   |   |
|                                  |         | 2   | 2  |          | 20'-0" |        |  |   |
|                                  | B       | 46  | 46 | 1/2"     | 5'-6"  |        | Hanging links splicing with above links in pairs at 8', 12', 18' and 24' centres |   |
|                                  | C       | 20  | 20 | 3/16"    | 5'-6"  |        |  |   |
|                                  | D       | 12  | 12 | 3/8"     | 5'-6"  |        |  |   |
|                                  | E       | 6   | 6  | 5/16"    | 5'-6"  |        |  |   |

Notes - Bars marked thus X in above schedule are allowed 5' in length for the purpose of up-selling

All main bar dimensions are overall thus.



Fig. 251.

| LIST AS TAKEN-OFF FROM SCHEDULE. |            |            |             |             |             |            |
|----------------------------------|------------|------------|-------------|-------------|-------------|------------|
| 1 7/8" φ                         | 1 1/2" φ   | 1 3/8" φ   | 1/2" φ.     | 7/16" φ     | 3/8" φ      | 5/16" φ    |
| 3 @ 59'-0"                       | 1 @ 27'-6" | 1 @ 48'-6" | 24 @ 14'-0" | 20 @ 14'-0" | 12 @ 14'-0" | 6 @ 14'-0" |
| 3 10'-0"                         | 2 32'-6"   | 1 53'-6"   | 2 14'-6"    | 20 5'-6"    | 12 5'-6"    | 6 5'-6"    |
| 2 65'-0"                         | 2 47'-6"   | 1 45'-6"   | 2 15'-6"    |             |             |            |
| 1 - 63'-6"                       | 2 31'-6"   | 1 37'-0"   | 2 16'-6"    |             |             |            |
| 2 52'-6"                         | 1 34'-3"   | 1 29'-6"   | 2 17'-6"    |             |             |            |
|                                  | 1 53'-3"   | 1 25'-6"   | 2 18'-6"    |             |             |            |
|                                  | 2 52'-6"   |            | 2 19'-0"    |             |             |            |
|                                  |            |            | 2 19'-6"    |             |             |            |
|                                  |            |            | 8 26'-0"    |             |             |            |
|                                  |            |            | 46 5'-6"    |             |             |            |

| COMPLETED LIST READY FOR TYPING. |        |        | TITLE & DRG NO. |                             |  |  |  |
|----------------------------------|--------|--------|-----------------|-----------------------------|--|--|--|
| 2                                | 1 7/8" | 65'-0" | 130             |                             |  |  |  |
| 1                                |        | 63'-6" | 63.5            |                             |  |  |  |
| 3                                |        | 59'-0" | 177             |                             |  |  |  |
| 2                                |        | 52'-6" | 105             |                             |  |  |  |
| 3                                |        | 10'-0" | 30              |                             |  |  |  |
|                                  |        |        | 505.5           | x 7.057 = 3,570 lbs         |  |  |  |
| 1                                | 1 1/2" | 53'-3" | 53              |                             |  |  |  |
| 2                                |        | 52'-6" | 105             |                             |  |  |  |
| 2                                |        | 47'-6" | 95              |                             |  |  |  |
| 1                                |        | 34'-3" | 54              |                             |  |  |  |
| 2                                |        | 32'-6" | 65              |                             |  |  |  |
| 2                                |        | 31'-6" | 63              |                             |  |  |  |
| 1                                |        | 27'-6" | 28              |                             |  |  |  |
|                                  |        |        | 443             | x 6.013 = 2,665 lbs         |  |  |  |
| 1                                | 1 7/8" | 53'-6" | 54              |                             |  |  |  |
| 1                                |        | 48'-6" | 48              |                             |  |  |  |
| 1                                |        | 45'-6" | 46              |                             |  |  |  |
| 1                                |        | 37'-0" | 57              |                             |  |  |  |
| 1                                |        | 29'-6" | 29              |                             |  |  |  |
| 1                                |        | 23'-6" | 24              |                             |  |  |  |
|                                  |        |        | 238             | x 5.053 = 1,203 lbs         |  |  |  |
| 8                                | 1/2"   | 20'-0" | 160             |                             |  |  |  |
| 2                                |        | 19'-6" | 39              |                             |  |  |  |
| 2                                |        | 19'-0" | 58              |                             |  |  |  |
| 2                                |        | 18'-6" | 57              |                             |  |  |  |
| 2                                |        | 17'-6" | 55              |                             |  |  |  |
| 2                                |        | 16'-6" | 33              |                             |  |  |  |
| 2                                |        | 15'-6" | 31              |                             |  |  |  |
| 2                                |        | 14'-6" | 29              |                             |  |  |  |
| 24                               |        | 14'-0" | 336             |                             |  |  |  |
| 46                               |        | 5'-6"  | 253             |                             |  |  |  |
|                                  |        |        | 991             | x 668 = 662 lbs             |  |  |  |
| 20                               | 7/16"  | 14'-0" | 280             |                             |  |  |  |
| 20                               |        | 5'-6"  | 110             |                             |  |  |  |
|                                  |        |        | 390             | x 512 = 200 lbs             |  |  |  |
| 12                               | 3/8"   | 14'-0" | 168             |                             |  |  |  |
| 12                               |        | 5'-6"  | 66              |                             |  |  |  |
|                                  |        |        | 234             | x 376 = 88 lbs              |  |  |  |
| 6                                | 5/16"  | 14'-0" | 84              |                             |  |  |  |
| 6                                |        | 5'-6"  | 55              |                             |  |  |  |
|                                  |        |        | 117             | x 261 = 31 lbs              |  |  |  |
|                                  |        |        |                 | Total Weight 3 - 15 - 1 - 0 |  |  |  |
|                                  |        |        |                 | Extended <u>    </u>        |  |  |  |
|                                  |        |        |                 | Checked <u>    </u>         |  |  |  |

Fig. 252.

A question arises on whether it is better to take off the steel sheets on the basis of certain specific parts of the work or on the basis of drawings. It is much more convenient, as well as being generally more satisfactory, to take off the steel drawing by drawing. The fact that a small portion of work included in a drawing may not be required for some little time is not really a serious matter, as the reinforcement required for the parts not to be immediately constructed may be suitably labelled and placed on one side for use when required. If the recommendations given are followed, and bending schedules included on the drawings on the lines already described, the taking off of the reinforcement can be carried out by a junior, but in every case the steel sheets should later be checked by a designer. Not only does this place responsibility for the correctness of the sheets in the right quarter, but, in addition, when going through the bending schedule the designer has an opportunity for a final check over the reinforcement and occasionally he may note where improvements or economies can be effected in time to take advantage of them.

It is a good plan also to include in the steel sheets for a small quantity of spare steel. The diameter and length of this depend to some degree on the particular work in question. The steel sent under this spare list should be in 18-ft. lengths so that it may be sufficiently long to allow for cutting to lengths required. A small quantity of spare steel not only facilitates the making of adjustments in the work at the site but is also of assistance in dealing with minor errors in the lists or the making up of the consignments at the works.

Some little time elapses between ordering the steel and delivery at the site, and where the work is urgent the steel is sometimes placed on order before working details are completed. This is a practice which should be avoided whenever possible, for the reinforced concrete detailer has sufficient to think about in interpreting correctly the calculations and arranging steel to suit them without the additional handicap of having to use steel of lengths and diameters already ordered. In addition, the practice is liable to lead to appreciable waste of steel not only in using diameters larger than necessary but also in cutting long bars and leaving short ends of scrap.

In large contracts care should be taken to ensure that the reinforcement is not requisitioned twice. To this end the copy of the steel sheets kept in the engineer's office should be marked duplicates of those issued to the contractor.

### **Contract Documents.**

On completion of the general drawings, or for preference on completion of the whole of the details, the engineer is called on to prepare his documents for the contract. The documents are divided into four parts. These are the Form of Tender and General Instructions to contractors tendering; the Conditions of Contract or the legal clauses of the contract; a description of the work, or the technical portion termed the Specification; and the Bill of Quantities with a Schedule of Prices appended. For the Form of Tender and the Conditions of Contract it is better for the engineer to make use of an earlier document in the preparation of which legal assistance has been obtained, adapting it where necessary to suit the requirements of the particular case. The Ministry of Transport issue a Form of Tender and Instructions to Contractors and Conditions of Contract for bridge work in Britain. Alternatively the Conditions of Contract issued by

the Institution of Civil Engineers in collaboration with the Federation of Civil Engineering Contractors is applicable (see Appendix I). So far as the description of the works, that is, the technical Specification, is concerned this should commence with a brief but comprehensive general description of the site and work to be done. A description of the materials to be used follows, and finally a series of paragraphs should describe in their correct sequence every operation and requirement from the taking over of the site to the completion and cleaning down of the finished work. If the Specification is prepared meticulously in this way it will usually give the contractor tendering a better conception of the work required than if the clauses are arranged in any other way. A typical specification is given in Appendix II, and this may be used as a model in preparing documents of this nature. It is a good plan for an engineer to make notes of any points which arise during the construction of any of his works and which cause him difficulty in the interpretation of his specification for that work; if he does this and alters his early specification, when dealing with further works he will in the course of time approach the perfect Specification.

There is a general impression that all specifications are unfair, and one must admit that they do ask much of a contractor. It should be remembered, however, that in preparing these documents the engineer is working in the service of his client, a considerable sum of whose money he is empowered to spend, and that it is his duty to safeguard the client's interests. It is therefore essential that the engineer shall have absolute authority in connection with works entrusted to him. At the same time he is usually placed in the position of arbiter between client and contractor, and having provided himself with authority by means of his specification he should use it in a manner scrupulously just to both the client and the contractor.

### **Bill of Quantities.**

Having completed the Specification the engineer then prepares the Bill of Quantities for the work. In dealing with this he may with advantage proceed on lines similar to those adopted in the technical specification, that is, commence with the first work to be done by the contractor on entering the site and proceed systematically through the whole of the construction of the bridge, giving each item in its correct constructional order. For example, a bill often commences with an item for "clearing the site," proceeding to the removal of turf from the area of the excavations, and then to the excavations including the necessary timbering and pumping. Next one would include for the blinding concrete over the area of the excavations, for the reinforcement of that part of the work, and for any contingent labours and materials. He would then include for any necessary back-filling of part of the excavation, and if he wishes the surplus to be used for any specific purpose requiring an additional price he would include an item for that also. This is merely typical of the order in which the items would be taken, and the same principle may be continued throughout the whole of the Bill.

A typical Bill of Quantities is given in Appendix III which illustrates the type of document suitable, but every structure requires to be treated individually on these principles to obtain the best results. At the end of the Bill it is a wise plan to include a list of the whole of the items in the specification so that the

contractor may, if he wishes, include a price for meeting the requirement of any individual Specification item in the event of his considering it is not fully covered in the Bill. The Bill should conclude with an allowance for contingencies and with a Schedule of Prices in which the contractor includes rates to fix the cost of different kinds of materials and labour in the event of additional work being carried out on a day-work basis. In this he should include for every probable item of labour or material which he thinks might under even exceptional circumstances be required in the construction of the work.

For works in Scotland in reinforced concrete there is what is known as "The Scottish Mode of Measurement," and whilst this was prepared to apply to building rather than to engineering works it is possible to adapt it to bridge construction. Unfortunately, however, it entails a very considerable increase in labour and in the number of items in the Bill, the advantage of which is doubtful for works of this kind. In consequence, therefore, it is not often adopted when engineering works are under consideration. For bridge construction the "Report of the Committee on Engineering Quantities" issued by the Institution of Civil Engineers is suitable; it deals with the classification of the various parts of the work, describes the methods of measurement and the units to be adopted, and gives rules for drafting the bill of quantities. A publication issued by the Ministry of Transport, "Notes on the Preparation of the Bill of Quantities. Part 2--Road and Bridge Works" (H.M. Stationery Office), gives the current requirements of the Ministry for this class of work.

## CHAPTER XII

### ESTIMATING

ESTIMATING is often considered as the complete operation of preparing preliminary designs and arriving at the cost of a bridge, but it is proposed here to deal only with the process of obtaining the approximate cost of a bridge which has already been designed, either in detail or in outline only. The important factors are the degree of accuracy which it is desired to obtain and the speed with which the estimate can be made. Speed depends mainly on accuracy. The estimate required may be an estimate from a small-scale drawing giving merely the important features of the structure, or an estimate from an  $\frac{1}{8}$ -in. scale working drawing showing the sizes of almost every member, or an estimate from the complete working details and contract drawings.

Estimating as understood by the engineer is entirely different from the intricate question of contractors' tenders, which depend upon an accurate costing system. We are only concerned here with the engineer's requirements in making estimates at various stages of bridge schemes. The nearest approach to a contractor's tender is where the cost estimate is based on a completed bill of quantities. Even here, however, the engineer's aim is to arrive at an average tender price and not the lowest possible tender, which in certain cases may be based upon a risk which a keen contractor may consider legitimate. Two ways (apart from errors) in which a contractor can get his estimate below that of his competitors are by seeing some hidden possibility and by making use of some resource not available to other contractors tendering.

The engineer's estimate will therefore, in general, lie between the lowest and the highest tender, and successful estimating largely depends upon considerable experience. The engineer requires to have a thorough knowledge of current prices of materials, labour costs, the natural difficulties likely to be encountered, the trend of prices when the estimate is made, the contractors available to undertake the work, the attractiveness of the project, and the supply of materials, labour, and transport. The question of labour and material costs may often entail enquiries in the district in which the bridge is to be built, but such enquiries must be pursued with caution and take into account the quantities of the various materials required. It will often happen in large schemes that materials obtainable locally will not be in sufficiently large quantities to keep the work going, in which event imported materials must be used with consequently higher transport costs. Again, the bridge may be a very small one and prices for the smaller quantities of some of the materials will then probably be rather higher. Labour costs may also be higher on small works due to the difficulty of providing continuous employment for some of the tradesmen. In such cases the contractor will have

to pay skilled men for doing stand-by work in order to have them available when they are required.

Some bridges, because of the natural difficulties to be surmounted, are not attractive to contractors because of the risks they will have to take, and in such cases tenders will be high. The engineer must not overlook the difficulties to the contractor of a particular site, or his estimate may be very much below the lowest tender.

The question of access to the site is not usually a serious one in the case of bridge works, but allowance must be made where the contractor has to operate within a confined working space. Often a bridge has to be built many miles from a large town, with the result that there are few, if any, local contractors able to carry out the work, and here, too, allowance has generally to be made for increased costs due to contractors bringing their skilled men a considerable distance to the work. Estimates for a small or medium sized bridge are usually the most difficult to make, and in such cases failure to take into account the factors referred to may result in an error of as much as 50 per cent.

As a check on estimates, cost charts giving the price per square yard of most types of bridges will be found useful, and a number of these, based on costs current in 1955, are given in *Figs. 253 to 264*. A contingency item should always be added to allow for unforeseen difficulties which may arise during the course of the work. These difficulties are mainly encountered during the construction of the foundations, and rarely is such an item unused at the end of the work. Some engineers and authorities make an allowance of 10 per cent. for contingencies in bridge works as this percentage has been found by experience to be satisfactory. A systematic approach is one of the secrets of success in accurate estimating, and this chiefly involves the preparation of a list of items prior to taking off the quantities. A schedule of prices of materials and rates of wages in 1955 are given in Appendix IV.

**First (Rough) Estimate.**

In the case of an estimate to be made from rough outline drawings the following items will generally be sufficient :

| Item | Description                                   | Unit   | No | Rate  | £ s d. |
|------|---|--------|----|-------|--------|
| 1    | Cost (from chart)                             | Sq yd. |    |       |        |
| 2    | Allowance for natural difficulties            | Sum    |    |       |        |
| 3    | Special finishes, stone facing, etc.          | Sq yd  |    |       |        |
| 4    | Extra cost of materials, labour and transport | Sum    |    |       |        |
|      | Contingencies (10 per cent.)                  | Sum    |    |       |        |
|      |   |        |    | Total |        |

This kind of estimate is merely a well-judged guess, but if based on experience it is usually sufficient in the very early stages. It should naturally be on the safe side but, in experienced hands, will not vary by more than 10 per cent. to 15 per cent. from the final estimate. The engineer can make such an estimate very quickly, and this is necessary as many estimates may have to be made in order to compare different schemes.



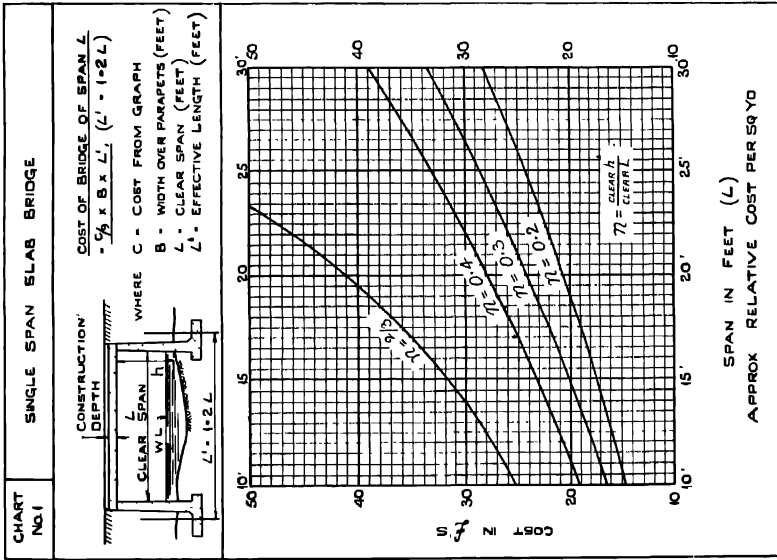

Fig. 253.—Cost of Single-span Slab Bridges.

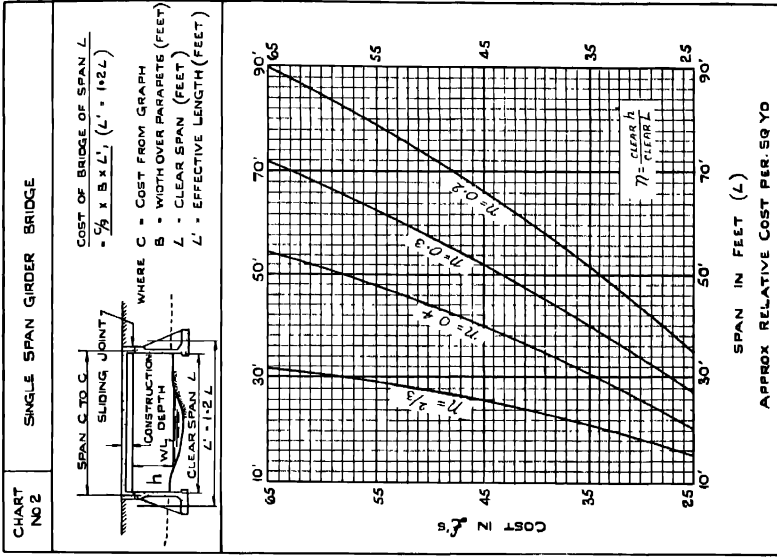

Fig. 254.—Cost of Single-span Girder Bridges.

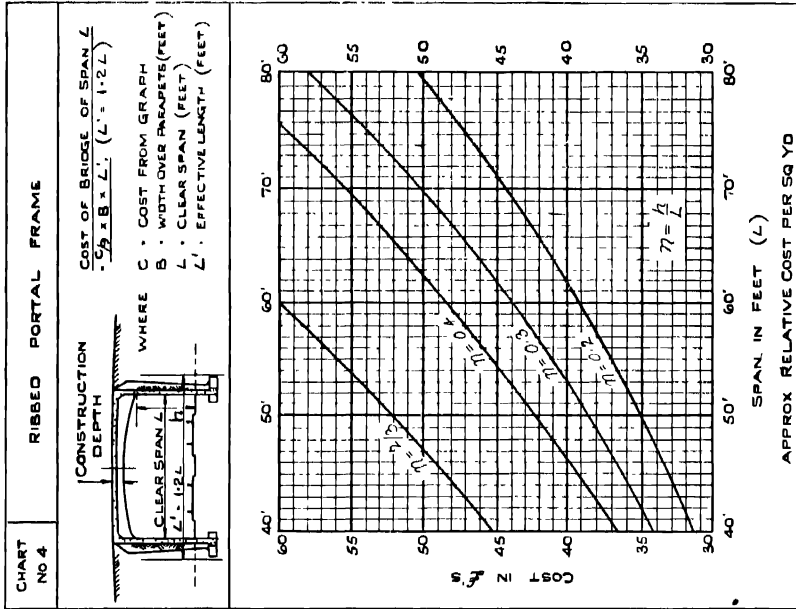

Fig. 256.—Cost of Ribbed Portal-frame Bridges.

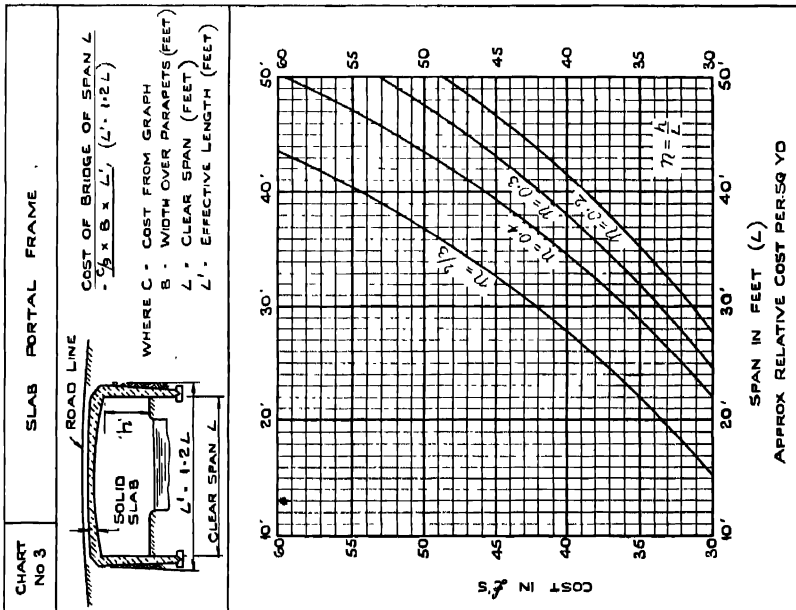

Fig. 255.—Cost of Portal-frame Slab Bridges.

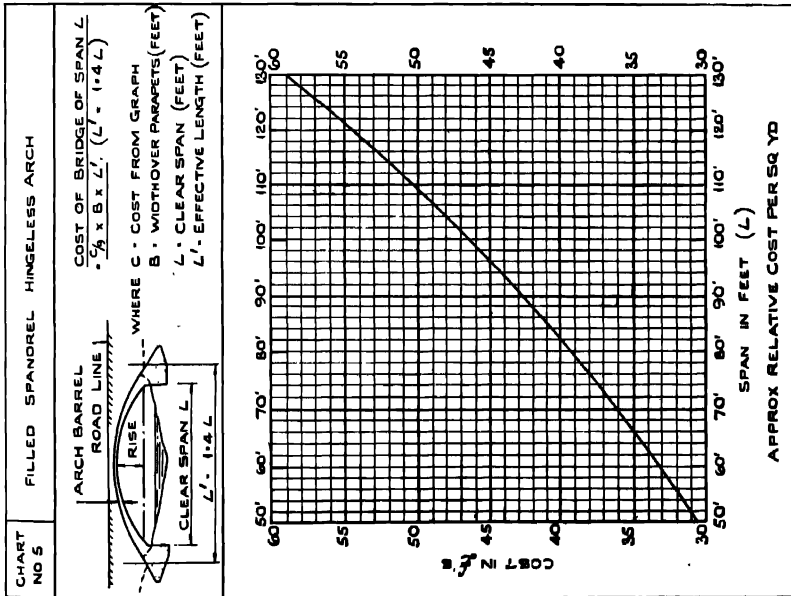
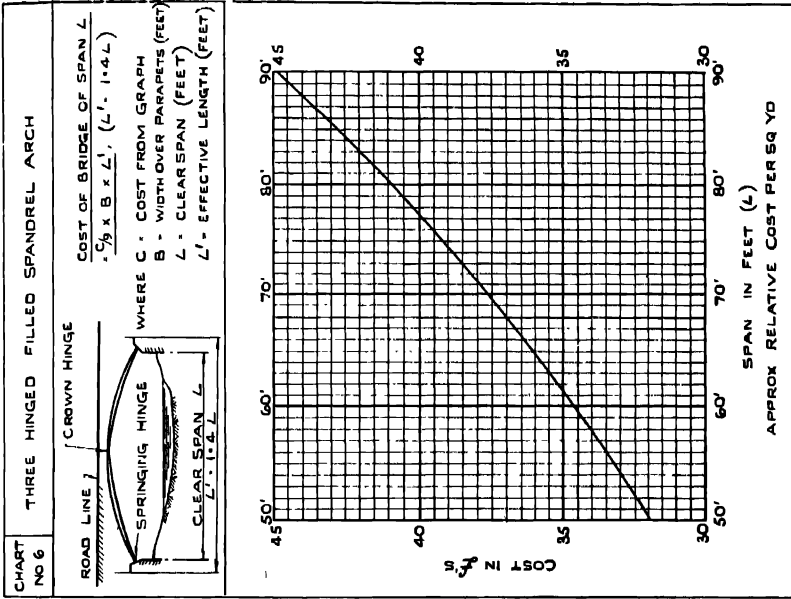

Fig. 257.—Cost of Hingeless Filled Spandrel Arch Bridges. Fig. 258.—Cost of Three-hinged Filled Spandrel Arch Bridges.

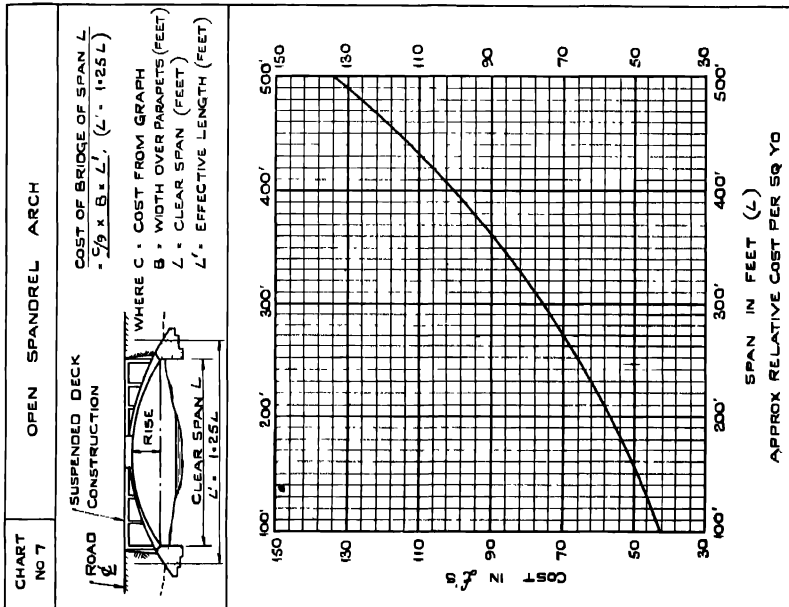

Fig. 259.—Cost of Open Spandrel Arch Bridges.

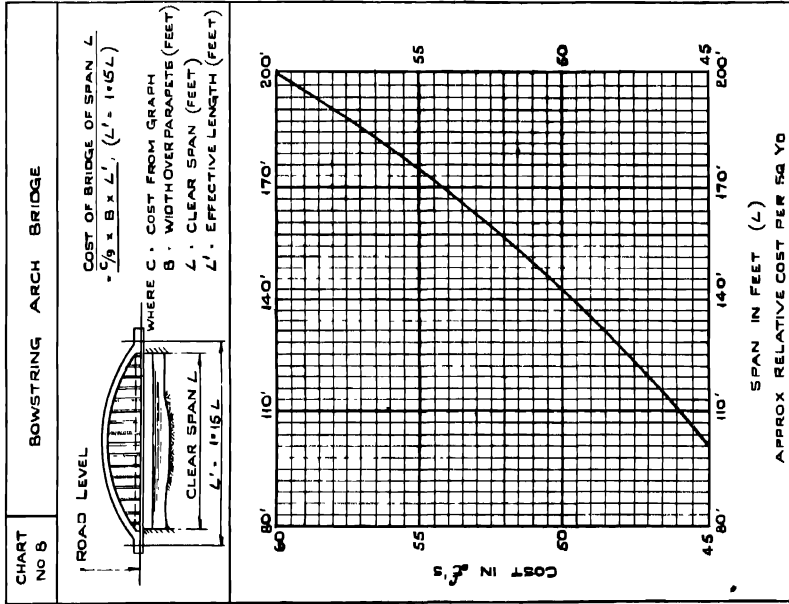

Fig. 260.—Cost of Bowstring Arch Bridges.

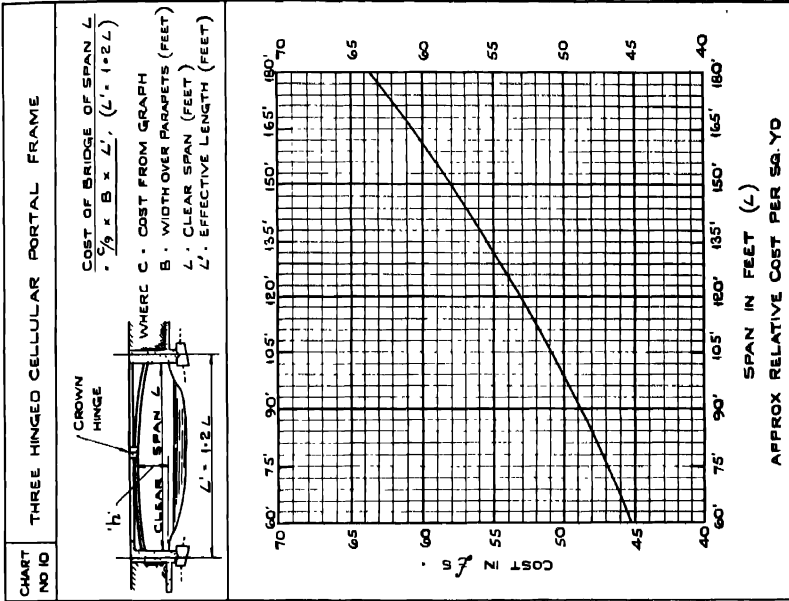

Fig. 262.—Cost of Three-hinged Portal-frame Bridges.

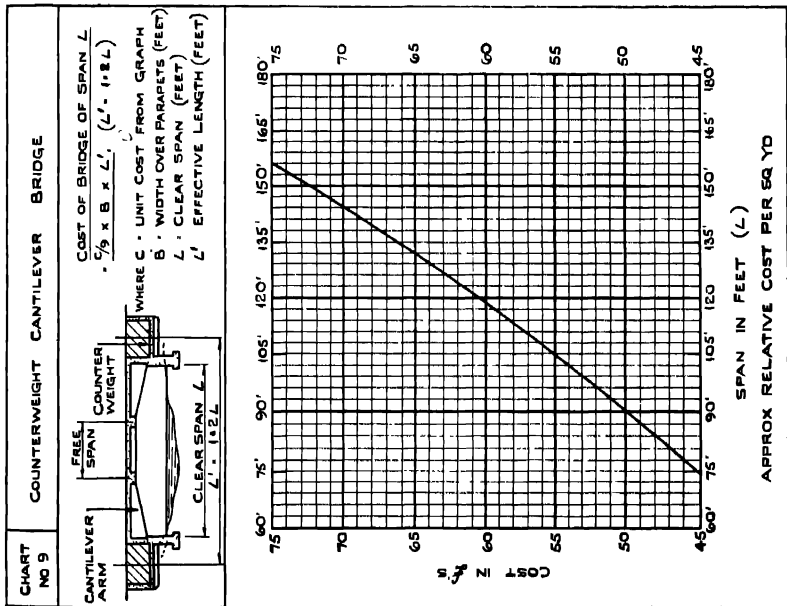

Fig. 261.—Cost of Cantilevered Bridges.

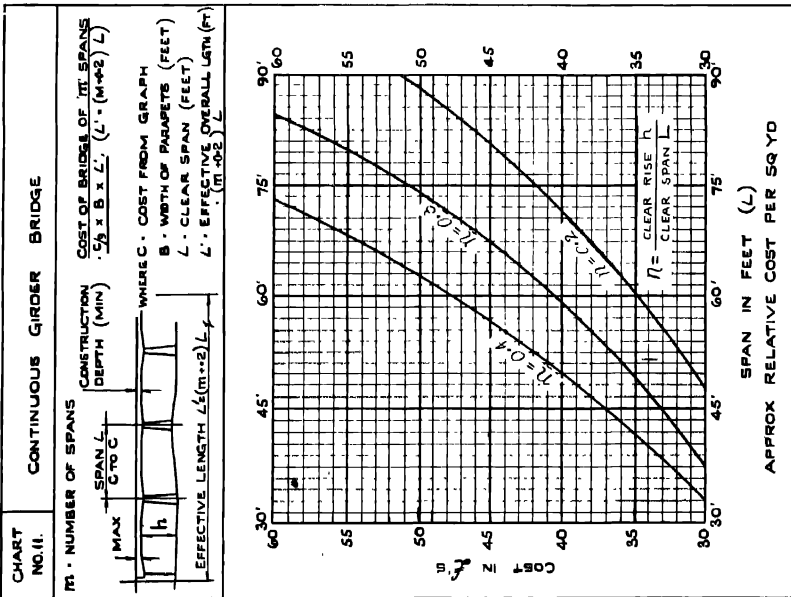

Fig. 263.—Cost of Continuous Girder Bridges.

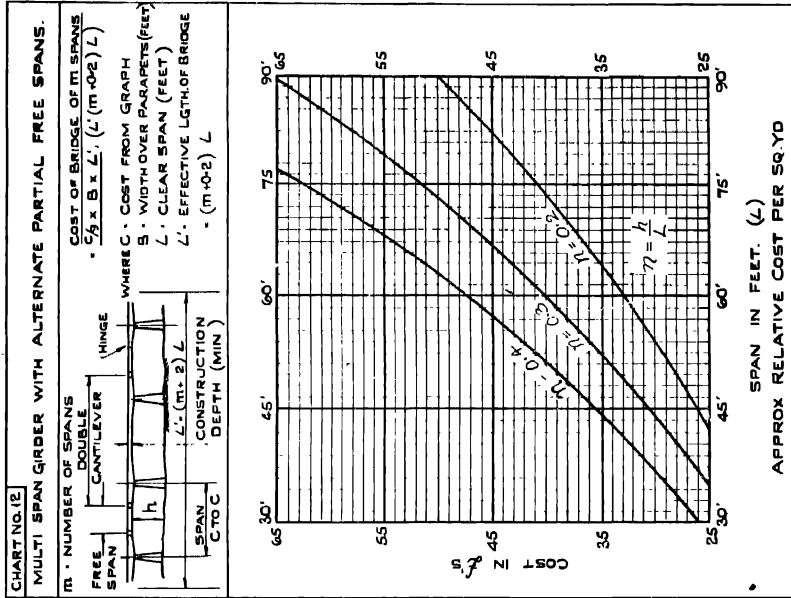

Fig. 264.—Cost of Multiple Span Cantilevered Bridges.



Considerable experience is again usually required in order to obtain accurate results from an estimate of this kind, but it can be made in, say, five to ten hours depending on the size of the work, and with surprising accuracy. It may be from 5 per cent. to 10 per cent. on the high side, depending upon the complexity of the work, but sound judgment is required. The quantities on which it is based should be measured to within  $2\frac{1}{2}$  per cent. to 5 per cent., depending upon the importance of the item, and the necessity for avoiding errors in the larger items cannot be over-emphasised; in such estimates small details are usually of little importance.

### Third (Complete) Estimate.

The third type of estimate is usually made when the detail drawings have been completed, and in such cases it is usual to prepare the estimate from the complete bill of quantities. Such an estimate is generally a much simpler matter than either of the two kinds already referred to, but here again attention should be concentrated on the prices for the larger items. It is worth while going to some trouble in making enquiries in order to be sure that the prices for large quantities of material are correct, but it is not usually necessary to do more than place conservative approximate prices against the smaller items. In a large office dealing with numerous bridge works, previously priced schedules may usually be consulted, and using these as a guide an estimate about  $2\frac{1}{2}$  per cent. to 5 per cent. above the lowest tender can generally be achieved.

### Requirements of the Ministry of Transport.

To summarise, the first method may be used when determining the most suitable type of bridge, and where this is not sufficiently accurate the second method may be employed. The third method is used before finally issuing the documents for tender purposes. The Ministry of Transport requires estimates for the following six items for its standard form: Direct labour work; Bridgework; Roadwork on bridge; Approaches; Property (including costs, legal charges, etc.); Any other expenses (clerk of works, engineer's fee, etc.). The second type of estimate is usually sufficiently accurate for this purpose, but occasionally the information may be obtained by pricing the items in the completed bill of quantities and re-grouping and abstracting these in accordance with the Ministry of Transport form.

### Examples of Estimates.

In order to show the steps involved in preparing an engineer's estimate, and also to demonstrate the use of the cost charts given in *Figs. 253 to 264*, estimates using methods (1) and (2) will be described in detail. The charts are based on prices in the summer of 1955 (see Appendix IV).

**METHOD (1).—PRELIMINARY COST OF BRIDGE AND ROADWORKS SCHEME FOR PURPOSE OF COMPARISON ONLY.**—This estimate can readily be prepared from  $\frac{1}{2}$ -in. scale plans and elevations as shown on *Fig. 265*. The scheme comprises a single main three-hinged portal frame (*Fig. 262*) of 170 ft. clear span across the river with five flood arches on the south approach of spans varying from 44 ft. to 50 ft. and with rises of 6 ft. to 7 ft. Each of these small arches is the segmental



three-hinged arch type with filled spandrels (*Fig. 258*). On the north there is one flood arch with a clear opening of 19 ft. 6 in., and the construction here is a portal-frame slab with filled spandrels (*Fig. 255*). The abutments, piers, and superstructure are all of reinforced concrete, and the foundations are assumed to rest on firm sandy gravel at the levels indicated. The work includes the demolition of an existing suspension bridge and the erection of a temporary timber bridge across the river—this bridge to be kept open to traffic during the whole construction period and to be dismantled on completion. The timber bridge is to be continued on both sides of the river, so as to link up with the main roads along the north and south banks. The site is about 40 miles from the nearest large town and the materials will require to be delivered mainly by road transport with the exception of the aggregate for the concrete which can be quarried locally.

As the river is liable to sudden and severe flooding the scheme has been designed to give a maximum waterway with as much clearance as possible towards the abutments and a minimum construction depth at the crown. The parapets are to be of precast concrete blocks and the exposed concrete surfaces are to be specially treated to produce a fine finish.

The foregoing data are sufficient for the preparation of a preliminary estimate of the total cost of the scheme, and this would be made up as follows.

| Item | Description   | Unit    | No   | Rate |    |   | £                   |
|------|---|---------|------|------|----|---|---------------------|
|      |   |         |      | £    | s  | d |                     |
| 1a   | Main bridge (170 ft span)—<br>Cost from chart No. 10 ( <i>Fig. 262</i> ):<br>34.5 × 170 × 1.2/9                   | Sq. yd. | 785  | 58   | 10 | 0 | 45,922              |
| 1b   | 5 South approach arches (47 ft aver span)—<br>Cost from chart No. 6 ( <i>Fig. 258</i> ):<br>34.5 × 235 × 1.4/9    | Sq. yd. | 1260 | 30   | 10 | 0 | 38,430              |
| 1c   | 1 North approach arch (19 ft. 6 in span)—<br>Cost from chart No. 3 ( <i>Fig. 255</i> ):<br>34.5 × 19.5 × 1.2/9    | Sq. yd. | 90   | 33   | 0  | 0 | 2,970               |
| 2    | Allowance for finishes, special features,<br>etc.   | Sq. yd. | 1140 | 1    | 0  | 0 | 1,140               |
| 3    | Approach roadworks and embankments<br>complete  | Sq. yd. | 1400 | 2    | 10 | 0 | 3,500               |
| 4    | Allowance for natural difficulties, tem-<br>porary timber bridge, and demolition<br>of existing suspension bridge | Sum     |      |      |    |   | 5,000               |
| 5    | Availability of materials, labour supply<br>and transport   | Sum     |      |      |    |   | 1,000               |
|      |   |         |      |      |    |   | 97,962              |
|      | Contingencies (10 per cent)   |         |      |      |    |   | 9,796               |
|      |   |         |      |      |    |   | Total . . . 107,758 |

METHOD (2).—ENGINEER'S ESTIMATE FROM  $\frac{1}{8}$ -IN. SCALE DRAWINGS.—When he is satisfied that the scheme is the best for the particular site and compares favourably in economy and suitability with schemes using other modes of construction, the engineer prepares  $\frac{1}{8}$ -in. scale drawings (see *Fig. 266*) and makes a more detailed estimate using the method that follows.

## REINFORCED CONCRETE BRIDGES

| Item                            | Description   | Unit     | No   | Rate    | £      | s. | d |
|---------------------------------|---|----------|------|---------|--------|----|---|
| 1                               | Clearing site . . . . .   | Sum      |      |         | 150    | 0  | 0 |
| 2                               | Taking down existing suspension bridge and demolishing old masonry arches, piers, and abutments . . . . . | Sum      |      |         | 650    | 0  | 0 |
| 3                               | Erecting temporary timber bridge, maintaining, and dismantling on completion . . . . .                    | Sum      |      |         | 6,000  | 0  | 0 |
| MAIN BRIDGE                     |   |          |      |         |        |    |   |
| 4                               | Cofferdams . . . . .  | No       | 2    | £750    | 1,500  | 0  | 0 |
| 5                               | Excavation . . . . .  | Cub. yd. | 1710 | 18s     | 1,539  | 0  | 0 |
| 6                               | Pumping . . . . .   | Sum      |      |         | 100    | 0  | 0 |
| 7                               | 6 in. blinding (1 : 3 : 5) . . . . .  | Sq. yd.  | 165  | 15s     | 123    | 15 | 0 |
| 8                               | 1 : 2 : 3 concrete in foundations . . . . .   | Cub. yd. | 380  | 90s     | 1,710  | 0  | 0 |
| 9                               | 1 : 2 : 3 concrete in abutment walls . . . . .  | Cub. yd. | 742  | 90s     | 3,339  | 0  | 0 |
| 10                              | 1 : 1 : 2 concrete in arch slab . . . . .   | Cub. yd. | 187  | 150s    | 1,402  | 10 | 0 |
| 11                              | 1 : 2 : 3 concrete in arch ribs . . . . .   | Cub. yd. | 388  | 90s     | 1,740  | 0  | 0 |
| 12                              | 1 : 1½ : 3 concrete in deck slab . . . . .  | Cub. yd. | 104  | 135s    | 702    | 0  | 0 |
| 13                              | 1 : 1 : 2 concrete in pilasters . . . . .   | Cub. yd. | 200  | 150s    | 1,500  | 0  | 0 |
| 14                              | Precast concrete caps to pilasters, including all moulds . . . . .  | Cub. ft. | 400  | 8s.     | 160    | 0  | 0 |
| 15                              | Shuttering in foundations (within cofferdams) . . . . .   | Nil      |      |         |        |    |   |
| 16                              | Shuttering in abutment walls . . . . .  | Sq. yd.  | 750  | 14s     | 525    | 0  | 0 |
| 17                              | Shuttering in arch slab (lagging) . . . . .   | Sq. yd.  | 700  | 25s     | 875    | 0  | 0 |
| 18                              | Shuttering in arch ribs . . . . .   | Sq. yd.  | 1820 | 21s     | 1,911  | 0  | 0 |
| 19                              | Shuttering in decking . . . . .   | Sq. yd.  | 538  | 25s     | 672    | 10 | 0 |
| 20                              | Shuttering in pilasters . . . . .   | Sq. yd.  | 357  | 20s     | 357    | 0  | 0 |
| 21                              | Mild steel reinforcement (supplying, bending, and fixing):  |          |      |         |        |    |   |
|                                 | (a) Substructure . . . . .  | Tons     | 100  | £70     | 7,000  | 0  | 0 |
|                                 | (b) Superstructure . . . . .  | Tons     | 150  | do      | 10,500 | 0  | 0 |
| 22                              | Screw couplings, upsetting and threading bars, and zinc spraying . . . . .                                | Sum      |      |         | 1,200  | 0  | 0 |
| 23                              | Allowance for expansion joints, special bearing plates, etc. . . . .                                      | Sum      |      |         | 250    | 0  | 0 |
| 24                              | Staging . . . . .   | Sum      |      |         | 3,000  | 0  | 0 |
| 25                              | Wrought-iron korb . . . . .   | Lin. yd. | 125  | 10s. 6d | 65     | 12 | 6 |
| 26                              | Paving . . . . .  | Sq. yd.  | 470  | 12s     | 282    | 0  | 0 |
| 27                              | Precast concrete parapets . . . . .   | Lin. yd. | 125  | 75s.    | 409    | 15 | 0 |
| 28                              | Special surface treatment . . . . .   | Sq. yd.  | 866  | 25s     | 1,082  | 10 | 0 |
| 29                              | Screeding and road surfacing across main bridge . . . . .   | Sq. yd.  | 420  | 30s.    | 630    | 0  | 0 |
| 30                              | Drainage on main bridge . . . . .   | Sum      |      |         | 150    | 0  | 0 |
| NORTH AND SOUTH APPROACH ARCHES |   |          |      |         |        |    |   |
| 31                              | Excavation . . . . .  | Cub. yd. | 2290 | 15s     | 1,717  | 10 | 0 |
| 32                              | Pumping . . . . .   | Sum      |      |         | 50     | 0  | 0 |
| 33                              | 6 in. blinding (1 : 3 : 5) . . . . .  | Sq. yd.  | 555  | 22s     | 610    | 10 | 0 |
| 34                              | 1 : 2 : 3 concrete in piers, wing walls, and abutments . . . . .  | Cub. yd. | 1160 | 90s.    | 5,220  | 0  | 0 |
| 35                              | 1 : 1½ : 3 concrete in arch barrels . . . . .   | Cub. yd. | 340  | 135s.   | 2,275  | 0  | 0 |
| 36                              | 1 : 2 : 3 concrete in spandrel walls . . . . .  | Cub. yd. | 140  | 90s.    | 630    | 0  | 0 |
| 37                              | 1 : 1 : 2 concrete in pilasters . . . . .   | Cub. yd. | 110  | 150s.   | 825    | 0  | 0 |
| 38                              | Precast concrete caps to pilasters, including all moulds . . . . .  | Cub. ft. | 90   | 8s.     | 36     | 0  | 0 |
| 39                              | Shuttering in piers, wing walls, and abutment . . . . .   | Sq. yd.  | 1193 | 14s     | 835    | 2  | 0 |
| 40                              | Shuttering in arch barrel . . . . .   | Sq. yd.  | 1253 | 20s.    | 1,253  | 0  | 0 |
| 41                              | Shuttering in spandrel walls . . . . .  | Sq. yd.  | 650  | 25s     | 812    | 10 | 0 |
| 42                              | Shuttering in pilasters . . . . .   | Sq. yd.  | 320  | 20s.    | 320    | 0  | 0 |

| Item   | Description   | Unit     | No   | Rate    | £       | s. | d. |
|--|---|----------|------|---------|---------|----|----|
| 43   | Supplying, bending, and fixing mild steel reinforcement in                          |          |      |         |         |    |    |
|  | (a) Substructure  | Tons     | 75   | £70     | 5,250   | 0  | 0  |
|  | (b) Superstructure  | Tons     | 80   | £70     | 5,600   | 0  | 0  |
| 44   | Allow for expansion joints, etc.  | Sum      |      |         | 0       | 30 | 0  |
| 45   | Staging   | Sum      |      |         | 1,800   | 0  | 0  |
| 46   | Paving  | Sq. yd.  | 410  | 18s     | 309     | 0  | 0  |
| 47   | Precast block parapets  | Lin. yd. | 200  | 75s     | 750     | 0  | 0  |
| 48   | Special surface treatment   | Sq. yd.  | 604  | 14s     | 404     | 10 | 0  |
| ROADWORKS OVER NORTH AND SOUTH APPROACH ARCHES |   |          |      |         |         |    |    |
| 49   | Filling over arch barrels   | Cub. yd. | 1400 | 9s.     | 0       | 30 | 0  |
| 50   | Ashes and bottoming, blinding, and rolling  | Sq. yd.  | 750  | 10s     | 375     | 0  | 0  |
| 51   | Tarmacadam  | Sq. yd.  | 700  | 8s      | 280     | 0  | 0  |
| 52   | First surface coat and spray  | Sq. yd.  | 700  | 5s      | 175     | 0  | 0  |
| 53   | Second surface coat and spray   | Sq. yd.  | 700  | 5s      | 175     | 0  | 0  |
| 54   | Footpaths (bottoming, ashes, blinding, and rolling)                                 | Sq. yd.  | 410  | 11s 6d  | 235     | 15 | 0  |
| 55   | Kerbs   | Lin. yd. | 200  | 12s     | 120     | 0  | 0  |
| 56   | Drainage  | Sum      |      |         | 180     | 0  | 0  |
| APPROACH EMBANKMENT AND ROAD WORKS             |   |          |      |         |         |    |    |
| 57   | Scarifying  | Sq. yd.  | 480  | 3s      | 72      | 0  | 0  |
| 58   | Filling to embankments (obtained from excavations)                                  | Cub. yd. | 1150 | 6s      | 345     | 0  | 0  |
| 59   | New filling to embankments  | Cub. yd. | 2800 | 10s 6d  | 1,170   | 0  | 0  |
| 60   | Ashes and bottoming, rolling and blinding   | Sq. yd.  | 1000 | 10s     | 500     | 0  | 0  |
| 61   | Tarmacadam  | Sq. yd.  | 1000 | 8s      | 400     | 0  | 0  |
| 62   | First surface coat and spray  | Sq. yd.  | 1000 | 5s.     | 250     | 0  | 0  |
| 63   | Second coat and spray   | Sq. yd.  | 1000 | 5s      | 250     | 0  | 0  |
| 64   | Footpaths (bottoming, ashes, tarmacadam, etc.)                                      | Sq. yd.  | 420  | 11s 6d. | 241     | 10 | 0  |
| 65   | Kerbs   | Lin. yd. | 230  | 12s     | 138     | 0  | 0  |
| 66   | Drainage  | Sum      |      |         | 110     | 0  | 0  |
| 67   | Soiling and sowing embankment slopes and verges                                     | Sq. yd.  | 1300 | 2s      | 130     | 0  | 0  |
| 68   | Walls and fencing   | Lin. yd. | 266  | 7s. 6d  | 99      | 15 | 0  |
|  | Allow 6 per cent. for general items including plant, offices, stores, testing, etc. |          |      |         | 85,217  | 0  | 6  |
|  |   |          |      |         | 5,112   | 19 | 6  |
|  |   |          |      |         | 90,330  | 0  | 0  |
|  | Contingency (10 per cent.)  |          |      |         | 9,033   | 0  | 0  |
|  |   |          |      | Total   | £99,363 | 0  | 0  |

The actual contract figure in 1939 was £32,000, and the increase in cost in 1955 of about 300 per cent. agrees fairly closely with the rise in costs since that date.

### Variations in Tenders.

Occasionally, when materials are scarce and most contractors are fully occupied, unexpected tender prices may be received, even for a large and highly satisfactory bridge project. These tenders may differ very considerably from the

engineer's estimate and it is necessary to analyse the tenders in order to find out whether they are genuinely keen offers made in good faith. In one large bridge work within the writers' knowledge all the tenders were at least 10 per cent. above the engineer's estimate, which was fairly conservative, and the highest was 60 per cent. above the estimate. A detailed analysis of the tenders disclosed the following interesting facts. The sum of the lowest prices for each item was one-third below the lowest tender, whilst the sum of the highest prices was nearly double that of the lowest tender. The analysis showed that the contractors had each filled in the schedule in a great hurry and without much consideration, the main desire being to complete the schedule and obtain the return of their deposited money without risking the possibility of obtaining the work at a low figure. Such instances are rare, but should be kept in mind in order to avoid unjustified criticism of the engineer's estimate if the unexpected happens.

Some contractors tender for bridge work with inadequate knowledge of the difficulties, with the result that very low tenders are occasionally received. In such cases tenders have been received 20 per cent. below the engineer's estimate, and very considerably less than the next lowest tender. Such tenders have to be accepted if the work comes under certain authorities, with the result that the contractor receives a sharp lesson in bridge construction and the engineer has endless trouble in an effort to obtain a reasonably sound job. Fortunately, however, such cases are becoming rarer and, provided that the engineer insists upon a high standard of workmanship, unsound contracting on bridge works will rapidly decrease.

It will be appreciated from the foregoing that accurate estimating cannot readily be taught, but can only be attained through familiarity with priced schedules on bridges actually constructed under widely varying conditions. Judgment is the chief feature of an engineer's estimate and, as has been stated before, it is entirely different from contractors' pricing, which is nearly always made from a completely detailed schedule of quantities and accurate knowledge of current prices and labour costs. An example of a contractor's estimate is given in the succeeding chapter.

## CHAPTER XIII

### CONSTRUCTION METHODS AND EQUIPMENT

PRELIMINARIES TO CONSTRUCTION—ESTIMATING CONTRACT TIME—PLANT AND ARRANGEMENT OF PLANT—COST ESTIMATES—CONSTRUCTION PROGRAMME—MAINTAINING TRAFFIC—SETTING OUT—EXCAVATION—CONSTRUCTION OF FOUNDATIONS—FILLING

It is assumed that a contractor undertaking the construction of a reinforced concrete bridge has a sound knowledge of concrete work. In this and succeeding chapters, therefore, construction methods, materials, plant, and related matters are discussed only insofar as they relate to the special problems met in bridge construction, and are dealt with from the point of view of the contractor. The need for close co-operation between the contractor and the designer throughout all stages of the work cannot be over-emphasised and the relationship should not be too formal but rather one of mutual aid. It is therefore essential for the designer to be familiar with the practical problems and difficulties of executing bridge contracts, and for the contractor to appreciate the aim of the designer. A well-written specification describing this aim and including only those restrictions and requirements essential to its attainment will do much to promote a proper understanding on the part of the contractor. The problems and their solutions, which are best considered in the sequence in which they are encountered in the course of the work, are dealt with in the following, and references are given to other parts of this book that deal with these problems in greater detail.

**PRELIMINARIES TO CONSTRUCTION.**—Many of the particulars described in Chapter II which the engineer requires for the preparation of the design, and the contract documents, are of value to the contractor when preparing a tender. Other information necessary may be obtained by inspection of the site and from public authorities concerned. A construction programme for the purpose of estimating the contract time, and later for the organisation of the work, is an essential preliminary, as is also the consideration of different constructional equipment and arrangements of the plant. Such matters affect the estimated cost of the works. Detailed consideration of programmes, plant arrangement, and cost estimates is given in the present chapter together with other preliminary matters such as provision for the maintenance of traffic and the setting-out of the works.

**EXCAVATION AND FOUNDATIONS.**—The treatment of foundations in Chapter VIII relates principally to the design of the substructure, although cofferdams and piling are considered. The illustrations showing timbering of excavation and other temporary work based on actual contracts should be studied by contractors with similar problems. The sections on foundations in the present chapter therefore deal primarily with various methods of excavating, together with some observations on foundation construction.

**CENTERING, SHUTTERING AND MOULDS.**—The design and construction of shuttering, centering, and other falsework required in bridge construction are dealt with in Chapter XIV.

**REINFORCEMENT.**—Bar-bending schedules are dealt with in Chapter XI. The ordering, storing on the site, bending, and fixing of reinforcement are dealt with in Chapter XV.

**CONCRETE MIXING, DISTRIBUTION, PLACING AND CURING.**—The essentials of these operations are given in Chapter XVI.

**SPECIAL FEATURES.**—Reference should be made to Chapter XVII for details of constructional procedures relating to precast members, jacking of arches, hinges, joints, waterproofing, drainage, and testing completed structures. The special problems encountered in the construction of culverts and subways and railway bridges are also dealt with in Chapter XVII. The surface finish of bridges and consideration of parapets are dealt with in Chapters I, IX, and X and, where they affect the shuttering, in Chapter XIV.

### **Preliminary Information.**

Upon receipt of an invitation to tender, the first step is to study thoroughly the conditions of contract, specification, bill of quantities, and drawings to ascertain the essential particulars and requirements. This enables a list to be compiled of information required and action to be taken preparatory to making-up the tender. This list would include, in addition to any items peculiar to a given contract, such items as :

**Materials :** Nearest sources of supply, prices, and method of delivery of aggregates, cement, timber, and materials required by all trades ; water and power supplies and the method of payment ; whether the restriction of the site necessitates the steel being bent before delivery.

**Labour :** Whether sufficient men are available locally or whether men must be taken to the site ; whether lodgings are available or living quarters have to be provided ; messing arrangements ; competence of local labour.

**Sub-contracts :** A list should be made of work that can be conveniently let to sub-contractors and quotations obtained ; all prime-cost items should be enumerated.

**Diversion of traffic, streams, or railways :** Whether a temporary bridge is required, and if so the loading ; whether the existing bridge is to remain open for traffic in the case of a reconstruction ; whether part of a new bridge has to be opened to traffic before completion of the whole ; navigation requirements in the case of a bridge over a river ; road signals, speed limitations, navigation lights, etc. ; interruption of work or limitation of working hours to suit traffic ; maintenance of rights-of-way.

**Plant :** Compare the most suitable equipment for the contract with the plant available ; consider the purchase or hire of additional plant ; ascertain if counterweight material for cranes is available locally.

**Site :** Whether demolition of existing buildings, tree-felling, etc., are necessary ; access for materials and plant ; if the bridge is to be over a river, cross-river facilities, the nature of the river (current, floods, character of bed and

FIG. 265.  
[SEE OVERLEAF FOR FIG. 266.]

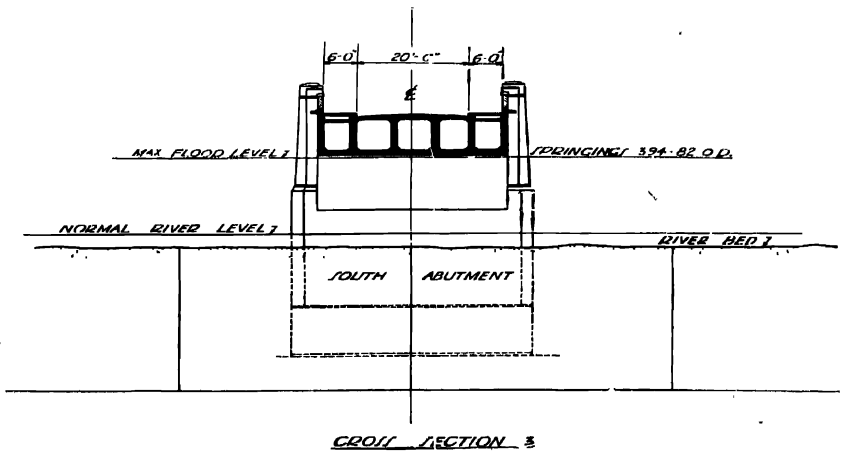
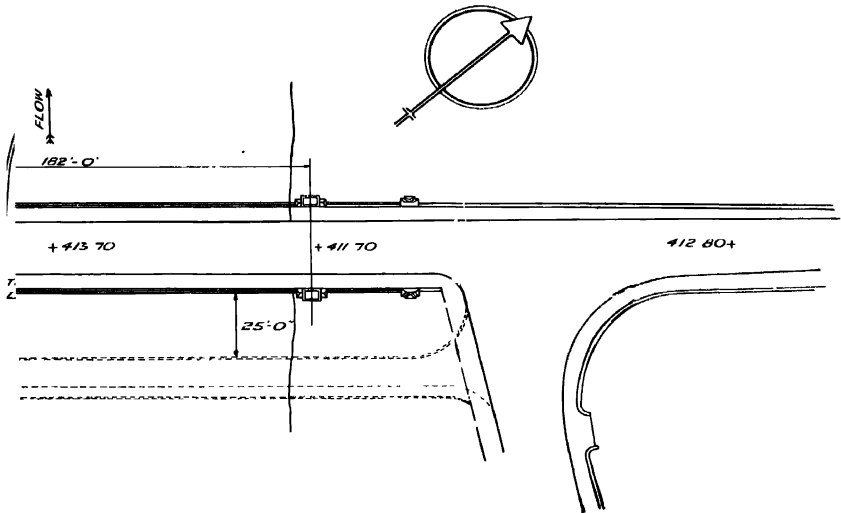
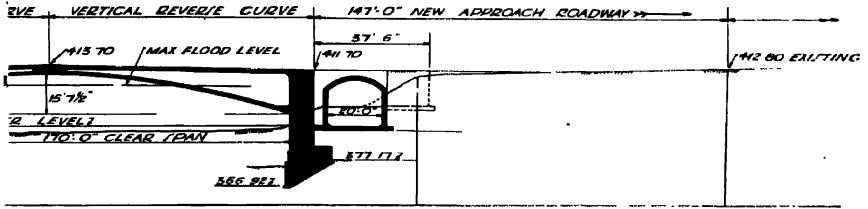





banks), whether the foundations have to be built in the dry (within cofferdams), piled, or under water; nature of ground; land available for site operations.

**Authorities :** Fees payable by the contractor to local authorities; submission of falsework plans or other particulars to the road, railway, or navigation authorities; whether detailed designs have to be prepared by the contractor and approved by the authorities.

**Financial :** Terms of payment; sureties; retention money; penalties and bonus; provisional sums; possible claims from adjoining owners.

The information under these headings, all of which affect the contract sum, is obtained by inspection of the site, by enquiries of suppliers, by the requirements of the contract documents, and if necessary by enquiry of the engineer and the authorities concerned. Upon being awarded a contract, the contractor has generally to consider the foregoing in greater detail, together with other factors such as the date of possession of the site and the condition of the site at that date, and the dates of delivery of the plant and first supplies of materials. These dates, and the time required to install the equipment and make preparation for the commencement of the work, have an important bearing on the construction programme.

### **Estimating Contract Time.**

The time-schedule or programme for the works is prepared in two stages. The object of the first, which is an approximate schedule showing only the major operations, is to assess the probable contract time, a statement of which usually accompanies the tender. Where more than one method of executing the work is possible, an approximate schedule should be prepared for each to establish the most efficient method.

In *Fig. 267* is given a sketch, approximate quantities, and an estimated time schedule for a filled-spandrel arch bridge. It is proposed to erect two derrick cranes to handle the excavation and the concrete. Essential preliminaries, including erecting the cranes, will occupy three or four weeks, but excavation for the abutments should be started within a fortnight. In soft ground above water level, excavation by hand will proceed more quickly than when hard ground is reached or when working within cofferdams. Abutment construction cannot commence until at least one excavation has been taken down to the full depth, and as both excavations will be proceeding concurrently (although they may be at different stages), concreting of the abutments cannot start until towards the end of the excavation period. Thus the excavation is the first of the critical operations and must be planned to maintain the scheduled speed. Owing to the comparatively small amount of excavation the provision of excavating machinery is not warranted, and therefore the method would be to dig and load by hand into lorries at first, and into crane skips when the cranes are ready for use.

The placing of the large volume of plain concrete in the abutments is the second critical operation, and it is proposed to install two 14/10 mixers, one on each side of the river. Work should commence on the second abutment as soon as excavation permits, and thus the construction of the two abutments proceeds simultaneously for most of the time. Distribution of the concrete from the mixers to the excavation need not control the speed, as the mixers can be arranged alongside the excavation.

The construction of the arch cannot begin until the abutments are complete, but the erection of the centering and shuttering for the arch and the fixing of the reinforcement can proceed while the abutments are under construction so that when the abutments are finished the concreting of the arch can begin without delay. With two mixing installations concreting can proceed outwards from each abutment simultaneously but, owing to the greater difficulty of distribution and placing, it is probable that the average daily rate will be less than that attained in the abutments. The daily rate will be further reduced when concreting the wing walls, spandrel walls, and parapets. Depositing the earth filling cannot proceed until the walls have matured. It is therefore advantageous to proceed with the walls simultaneously with the arch, as there may be periods

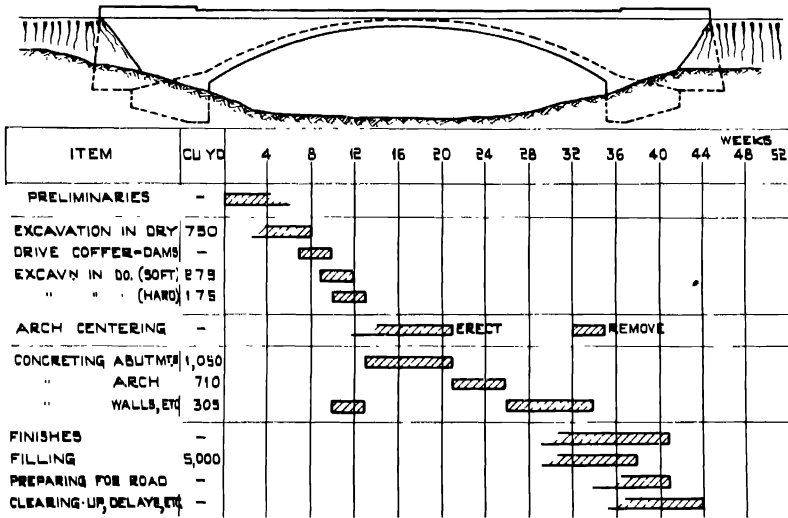

Fig. 267.—Estimating Contract Time.

when the concrete placers on the latter cannot cope with the maximum output of the mixers.

In the example the roadway is to be laid by the local authority on consolidated earth filling deposited by the contractor. A reasonable time for clearing-up and possible delays must be allowed, and should only allow for matters within the contractor's or supplier's control, such as under-estimation of time or delay in delivery of materials. Delays due to bad weather, abnormal floods, strikes, labour shortages, extra work ordered by the engineer, and similar occurrences cannot be assessed. In Fig. 267 it is seen that the estimated contract time is about ten months. The provision of sufficient sheet piling for one cofferdam only, or enough centering for a half-width of the arch, would reduce the cost of the plant but would seriously extend the contract time, and possibly endanger the chance of obtaining the contract. When the contract has been secured, a detailed construction programme (Fig. 277) is prepared.

### Construction Plant.

When preparing the contract time-schedule it is necessary to consider roughly what equipment will be necessary to deal with the work, but before the cost estimate can be prepared a closer study of the plant required and its arrangement is essential. On bridge contracts the equipment is the same as is used in normal reinforced concrete construction and in particular the following.

Plant used for general purposes about the site includes narrow-gauge rail tracks and equipment, derrick or locomotive cranes, overhead ropeways in special circumstances, and timber or steel scaffolding.

The most suitable types of excavating machinery for bridge contracts are shovels and trenchers, and grabs for excavating inside cofferdams and timbered excavations. For the latter purpose cranes with skips are also commonly used. Other plant for foundation construction includes pumps and driving plant for sheet piles and bearing piles.

Equipment for concreting operations may include aggregate crushing, screening, washing, and batching plants, storage bins, chuting plants, conveyors, and concrete pumps, in addition to concrete mixers.

Concrete materials and reinforcement may be delivered by rail, road, or water, depending upon the transport facilities at the site and at the source of supply. Lorries would be used in cities and where good roads connect the source of the aggregates and the site. For sites on navigable rivers and canals, materials can be delivered by ship or barge, but economical transport by water or rail necessitates that the source of supply as well as the site be alongside a waterway or railway. Concrete mixers, scaffolding, and other equipment are normally transported from the contractor's yard to the site by lorry or rail, while lorries are also used to convey workmen to and from isolated sites. Short end-tipping lorries with capacities up to 4 cub. yd. are used for conveying aggregates, but long drop-side lorries of up to 5 tons capacity are more suitable for reinforcement. Similar lorries, but with capacities up to 20 tons including a trailer, may be used for delivering cement, and in such a case temporary roads on the site should be capable of bearing this weight.

Excavated material from open sites may be conveyed by jubilee wagons or lorries to a dump, but from town sites surplus material is usually loaded directly into lorries for disposal. On small contracts the concrete materials are generally taken from the storage heaps to the mixers in wheelbarrows, in which also concrete is often taken from the mixer to the concreting position. Hand-carts or jubilee-type wagons are also used for this, but where the distance from the mixer to the work approaches 100 yd. it is worth while using mechanically-propelled vehicles. If the concreting position is not conveniently accessible, bottom-opening crane skips may be employed. For wheelbarrows or hand-carts, timber tracks adjustable to the exigencies of the site are required. Gradients for hand-propelled barrows or carts should not in general exceed 1 in 30 nor be more than 1 in 12 over a length of more than a few feet. Lorries require sleeper tracks or similar roads on almost all types of ground.

Stationary cranes for bridge construction are usually the derrick type, driven by steam or electricity. The capacity may be up to 20 tons with jibs up to 120 ft., a useful machine being a 5-ton crane with an 80-ft. jib having a working

radius of about 75 ft. The counterweight is provided by bricks, blocks of stone, iron, pile heads, or similar material. Two derrick cranes operating on the congested site of a bridge contract are illustrated in *Fig. 268*. In this position the cranes can handle all the materials required as well as being used for driving the steel sheet piling for the cofferdams and the timber piles for the trestles. Other examples of cranes used on bridge work are given later. Travelling cranes, steam or electrically driven and running on rails, road wheels, or self-laying tracks, work either at ground level or on temporary timber gantries. They have a wide range of capacities, but capacities of 2 tons to 5 tons are useful where a mobile crane can be used to advantage. Derrick cranes can also be used as travelling cranes by mounting the platforms on bogies running on two parallel rail tracks, and in this form have been found useful in a large pile-yard.

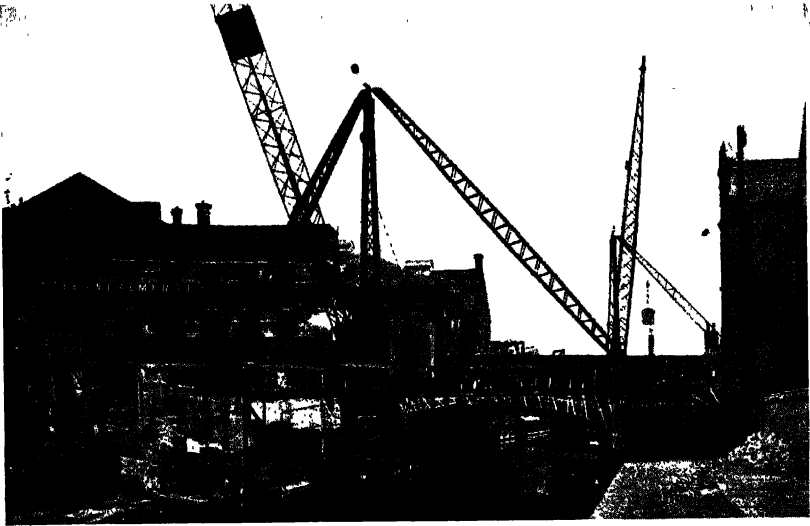

**Fig. 268.**—Derrick Cranes used in Bridge Construction.

Temporary timber gantries are used for crane or runway tracks, for supporting pile drivers, or for similar uses. They are generally made from 12-in. by 12-in. or 10-in. by 10-in. horizontal and vertical timbers, bolted or spiked together, and well braced diagonally. The verticals are driven into the ground as piles when the bearing power of the ground is low or when the staging is over water. When on good ground they rest on a ground frame. The verticals should be from 10 ft. to 15 ft. apart, braced in both directions at the top and bottom and at intermediate points not more than 10 ft. apart. Stages only one bay wide should be double-braced laterally with diagonal timbers, but elsewhere single half-timber braces alternately in opposite directions are sufficient. Splices in horizontal timbers should be made over the heads of vertical timbers, while splices in the latter should be cleated on all four sides. If the gantry carries a

rail track the horizontal timbers should be provided directly under the rails. For large spans or exceptional loads steel joists are used for the main girders of a gantry. Where possible, the beams and posts of a timber gantry should be designed for the loads to which they will be subjected. Expressions for determining the safe load on timber piles, posts, and beams are given later.

### Arrangement of Plant.

The efficiency of the construction is influenced by the way in which the plant is arranged. If the same plant is employed on successive operations construction should be arranged so that these operations follow one another with a minimum handling of materials. The major pieces of stationary equipment, such as large concrete mixers, derrick cranes, material bins, access roads, and rail-tracks, should, if practicable, be able to maintain efficient service throughout the contract without being moved. Portable mixers, pumps, compressors, bar-bending machines, carpenters' benches, and timber runways are items that can be readily

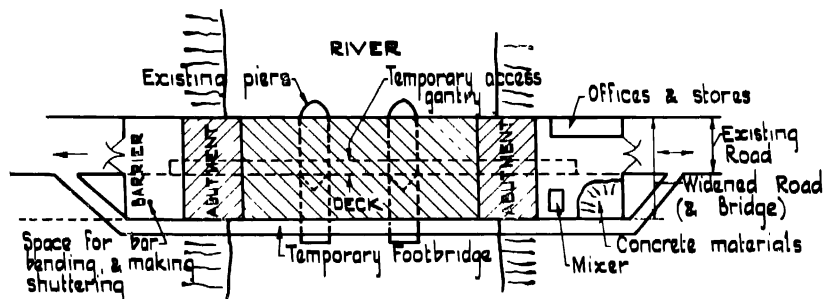

Fig. 269.—Arrangement of Plant for Replacement and Widening of Bridge on Congested Site.

moved to different positions as the work proceeds. The position of any piece of plant should be decided with reference to the supply of materials and the position to be occupied in the work by these materials. Where possible, separate entrances and exits should be provided for vehicles delivering materials. Stores for materials should be situated so that the distances from the arrival point to the store and from the store to the work are a minimum.

The procedure, and therefore the arrangement of the plant, depends upon the type of bridge, the size and number of spans, the available working area, and whether traffic has to be maintained under or over the bridge. The arrangement of the plant depends especially upon whether work can proceed from one end only or from both ends at the same time. The examples of typical arrangements of plant in *Figs. 268 to 276* are based on actual contracts.

As already described, two steam-operated derrick cranes were installed for the reconstruction of the canal bridge shown in *Fig. 268*. The congestion of this town site was aggravated by the necessity to maintain the existing tramway service. The concrete mixer was placed in a clearing on one bank of the canal, the aggregates being brought to the site by road. From this position the concrete

was transferred to the placing point by the cranes, which also handled any excavated material and the piles.

A suitable arrangement for replacing an existing multi-span bridge by a single-span and wider structure is shown in *Fig. 269*. In this example there was no need to keep the existing road open, but a pedestrian crossing over the river had to be maintained. The congestion of the site necessitated all operations being carried on within the boundaries of the new work and its approaches. The existing bridge was demolished, except for the two mid-stream piers which were temporarily extended in timber to provide a support for the deck centering

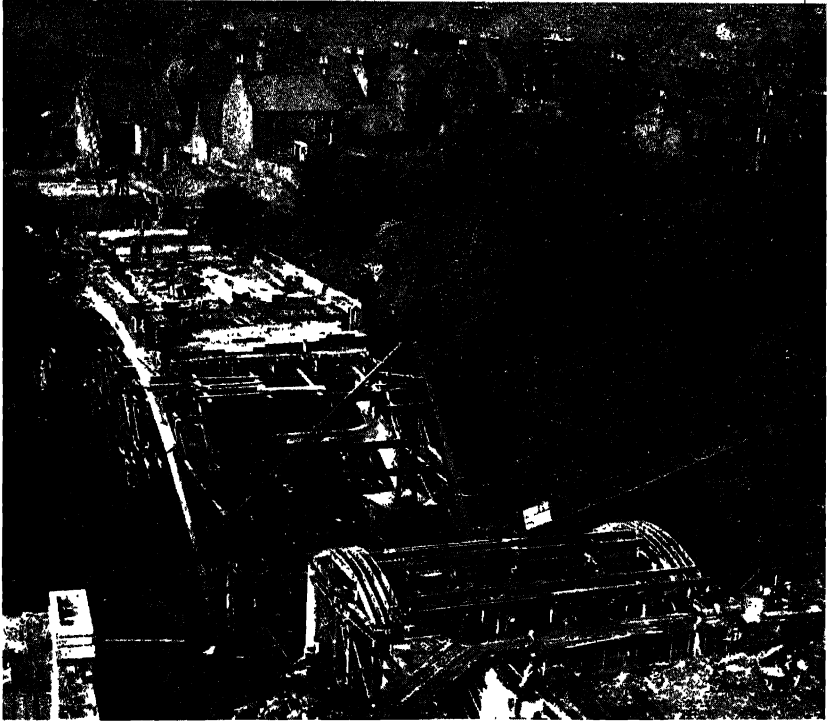

**Fig. 270.**—Construction of a Bridge over a Deep Valley.

and temporary footbridge. A temporary access gantry was erected above the level of the deck for the passage of hand-carts carrying concrete from the mixer to all parts of the new structure. The concrete materials were delivered by road to one end of the bridge where the mixer was placed at road level. If the contract were large enough a mixer at both ends of the bridge would accelerate progress. A mobile crane at each end of the bridge would lift skips of excavated material out of the abutment excavations and discharge into lorries.

The construction of a large arched bridge over a deep valley is illustrated in *Fig. 270*. In this case a derrick crane was erected over each of the two arch

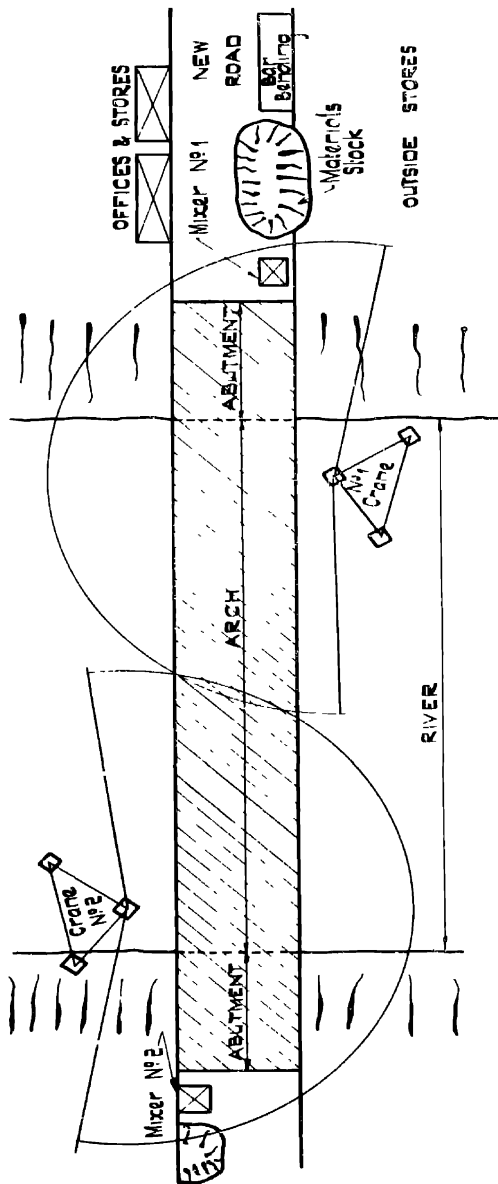

Fig. 271.—Arrangement of Plant for Medium Single-span Bridge.

abutments, in which position almost any part of the work could be reached for the purpose of removing excavation, depositing concrete, and handling shuttering and reinforcement. A similar arrangement is shown in *Fig. 271*, where two electrically-operated derrick cranes, having 80-ft. jibs and capable of lifting 1 ton at a radius of 75 ft., reached all parts of the work. A mixing installation was provided at both ends of the bridge, since access was available to both ends, and the concrete was taken to the work in bottom-opening skips handled by crane.

The span of the bridge in *Fig. 272* was too great to enable all parts of the work to be reached by two cranes and access was only available from one side of the river. Thus the concrete mixing installation was placed on one bank only, where were also the stores, offices, steel bending yard, and power-house. The latter was required owing to the isolation of the site, and was equipped with a 110-h.p. Diesel-electric set. The cranes were electrically-operated and each had a 90-ft. jib with a lifting capacity of 5 tons at 65-ft. radius. Temporary timber piers were erected in the river to support the arch centering and a low-level temporary bridge laid with jubilee track so that materials prepared on the right-hand bank could be transported to within reach of the crane on the left-hand bank. The concrete was discharged from the mixer into skips which were either taken by crane No. 1 direct to the right-hand side of the work or placed on flat bogies and hauled across the temporary bridge to be picked up by crane No. 2. Over the central portion of the work not reached by either crane, a high-level gantry was erected from which concrete was discharged from concrete carts, skips, or detachable bodies of jubilee wagons, hoisted on to the gantry by crane No. 1. This arrangement of cranes is sometimes necessary when the bridge spans a valley with steep sides, in which circumstances the cranes are placed as near the top of the slope as convenient in order to reduce the height of the towers.

The construction of the larger bridge illustrated in *Fig. 273* was carried out with the aid of eight cranes so arranged that most parts of the work could be reached by two cranes with 110-ft. jibs. Two cranes were carried on temporary platforms supported on timber piles beyond the cut-waters of each of the two river-piers, the latter being therefore protected by supporting trestles. Two cranes were also erected on each bank, where two independent installations of concrete batching and mixing equipment were provided.

A different arrangement was used for the construction of the bridge to which *Figs. 274* and *275* refer. In this case the original masonry bridge lay athwart the site of the foundations for the new bridge. A temporary bridge for road traffic and an independent temporary bridge for pedestrian traffic were therefore erected, and the original bridge demolished. The cofferdams for the four piers were then driven (*Fig. 274*), and a temporary stage, carried on timber piles, and two 5-ton derrick cranes with a working radius of 90 ft. were erected in the river on one side of the site of the new bridge. On this stage, piles were cast and the concreting plant was installed. The cranes were used for handling materials from the demolition of the existing bridge and the concrete for the new bridge.

A method sometimes adopted when building a bridge over a deep gorge is to employ an aerial ropeway, the ends of which are anchored at points sufficiently high on either side of the site. An example of this method is shown in *Fig. 276*, in which case the centre-lines of the bridge and the ropeway did not coincide owing to difficulty in positioning the anchorages. The skip on the traveller was



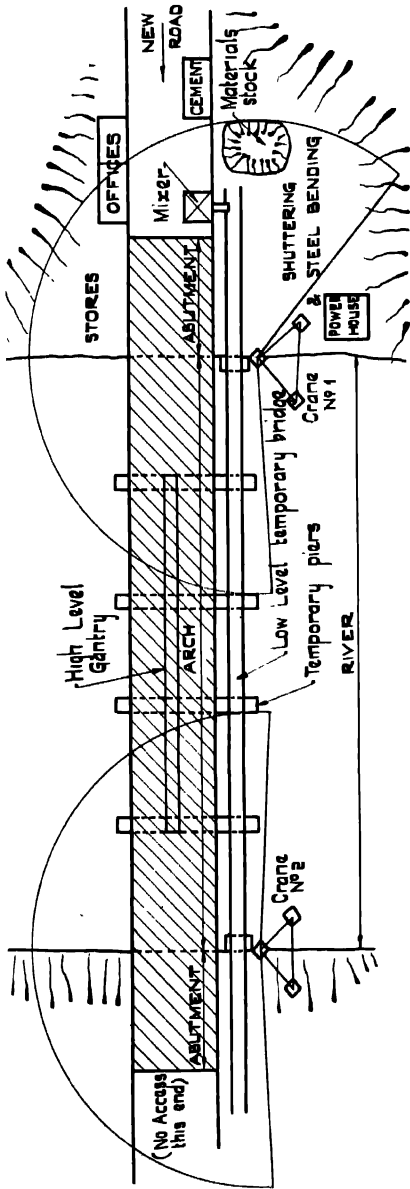

Fig. 272.—Arrangement of Plant for Long Bridge using Two Cranes.

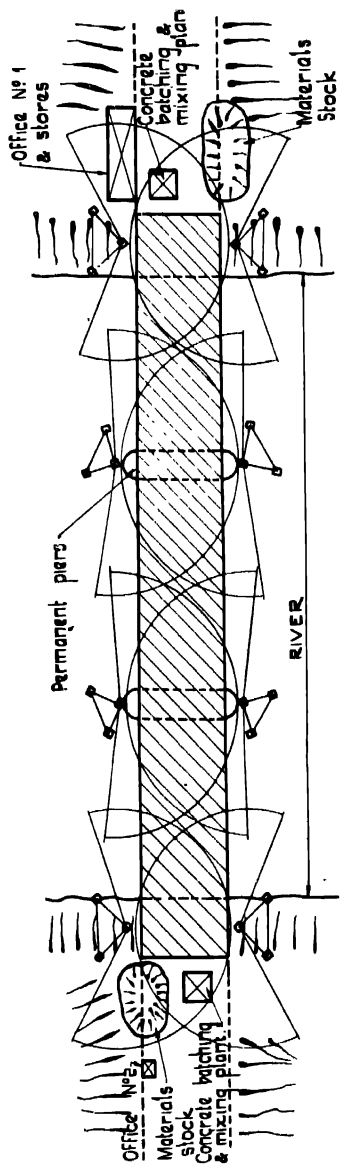

Fig. 273.—Plant Arrangement for Large Bridge.



Fig. 274.—Bridge Construction from a Working Stage.

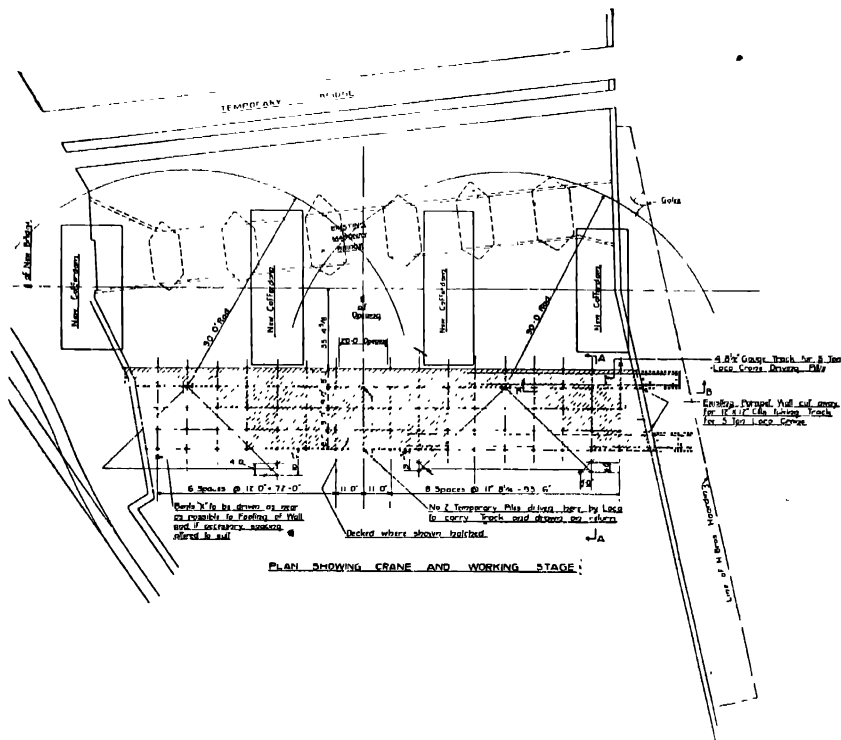

Fig. 275.—Arrangement of Plant with Working Stage.

filled at the concrete mixing plant and, by means of the ropeway, traversed the length of the bridge to the concreting position.

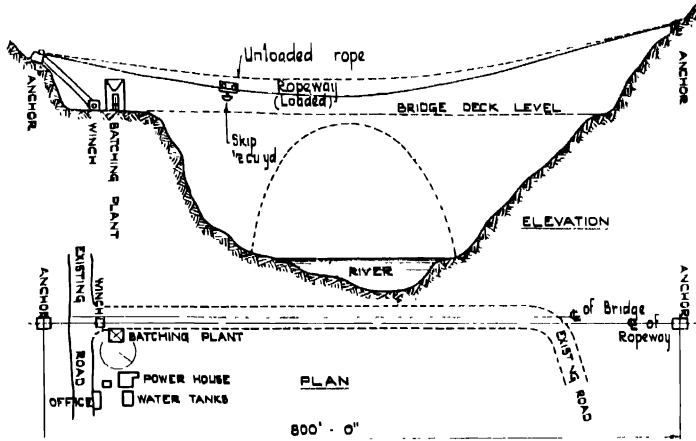

Fig. 276.—Arrangement of Plant with Overhead Ropeway.

**Cost Estimate.**

In Chapter XII consideration was given to the preparation of an engineer's estimate of cost for a bridge contract. A method of estimating the cost of the work for the purpose of preparing a contractor's tender is described here. As in Chapter XII, the prices are based on the rates current in 1955,\* but although the prices may require adjustment the method of assessing the contract sum is shown.

The major items in the bill of quantities have been considered in preparing the estimate of the contract time (ten months, as in Fig. 267), but now every item must be dealt with in detail. The bill of quantities is as follows.

**BILL OF QUANTITIES.**

|   |  |             |
|---|--|-------------|
| PERMANENT WORK (quantities supplied by the engineer) —                                  |  |             |
| 1. Excavation above water level   |  | 750 cu. yd  |
| 2. Excavation below water level   |  | 275 "       |
| 3. Excavation in hard material below water level  |  | 175 "       |
| 4. Concrete (1 : 3 : 6) in abutments  |  | 1050 "      |
| 5. Concrete (1 : 2 : 4) in spandrel and wing walls, including foundations to wing walls |  | 230 "       |
| 6. Concrete (1 : 1½ : 3) in arch slab   |  | 710 "       |
| 7. Concrete (1 : 2 : 4) in parapet  |  | 35 "        |
| 8. Shuttering to abutments  |  | 345 sq. yd  |
| 9. Shuttering to spandrel and wing walls, including vertical face of arch slab          |  | 1500 "      |
| 10. Shuttering to soffit of arch slab   |  | 720 "       |
| 11. Shuttering to parapet   |  | 400 "       |
| 12. Reinforcement (total weight of all sizes)   |  | 115 tons.   |
| 13. Finish to exposed surfaces  |  | 950 sq. yd  |
| 14. Earth filling (excluding approaches)  |  | 5000 cu. yd |
| 15. Preparing surface of filling for road   |  | 950 sq. yd  |
| 16. Drainage  |  | Item.       |
| 17. Insurance of works  |  | Item.       |
| 18. Concrete tests  |  | Item.       |
| 19. Contingencies   |  | Item.       |

\* See Appendix IV.

## TEMPORARY WORK (quantities measured by contractor) -

|  |              |
|--|--------------|
| A. Cofferdams, average 10 ft. deep . . . . .   | 300 lin. ft. |
| B. Timber in centering for arch slab . . . . . | 6000 cu. ft. |

An approximate price can be determined from the charts in Chapter XII. In the case of the bridge in *Fig. 267*, a filled-spandrel hingeless arch of about 145 ft. span and 40 ft. wide, the chart in *Fig. 257* is used. By extrapolation, the approximate unit cost is about £60 per square yard, the total approximate cost therefore being  $\frac{60}{9} \times 40 \times 1.4 \times 145 = \text{£}54,000$ , or say  $\text{£}52,000$  as the road is excluded from the contract. This preliminary value enables an idea to be formed of how much should be spent on plant.

The detailed analysis of the estimated costs is considered in the following sections: (1) Labour. (2) Materials. (3) Plant. (4) Site offices and staff, general on-costs, etc., and (5) Final make-up.

LABOUR.—The unit cost of labour for each operation is usually based on the contractor's records of comparable contracts. Only labour definitely attributable to particular items is included in this schedule, which is prepared as follows.

| Item No          | Description             | Quantity     | Labour rate | Total<br>£ s. |
|------------------|-------------------------|--------------|-------------|---------------|
| 1.               | Excavation above water  | 750 cu yd    | 11s od.     | 412 10        |
| 2.               | Excavation below water  | 275 "        | 10s od.     | 220 0         |
| 3                | Excavation in hard soil | 175 "        | 31s 6d.     | 275 10        |
| 4.               | Concrete in abutments   | 1050 "       | 19s. 6d.    | 1023 0        |
| and 6            | R.C. in walls and arch  | 940 "        | 26s. od.    | 1222 0        |
| 7.               | Concrete in parapet     | 35 "         | 38s 6d.     | 67 10         |
| 8                | Shuttering (abutments)  | 345 sq yd    | 9s od.      | 155 0         |
| 9.               | Shuttering (walls)      | 1500 "       | 10s od.     | 750 0         |
| 10.              | Shuttering (arch)       | 720 "        | 9s. od.     | 324 0         |
| 11.              | Shuttering (parapet)    | 400 "        | 12s. 6d.    | 250 0         |
| 12               | Reinforcement . . . . . | 115 tons     | £10 10s.    | 1207 10       |
| 13               | Finishes . . . . .      | 950 sq. yd   | 5s. od.     | 237 10        |
| 14               | Filling . . . . .       | 5000 cu. yd. | 3s. od.     | 750 0         |
| 15.              | Prepare for road        | 950 sq. yd.  | 3s. od.     | 142 0         |
| Total net labour |                         |              |             | £7036 10      |

MATERIALS.—In this section only the calculated unit rates for inclusion in the final make-up are determined.

## Concrete—

| Item No.                                 | 4.               | 5 and 7.         | 6.               |
|--|------------------|------------------|------------------|
| Mixture                                  | 1 : 3 : 6        | 1 : 2 : 4        | 1 : 1½ : 3       |
|  | s. d.            |                  | s. d.            |
| 1½-in. aggregate @ 20s. per cu. yd.      | ¾ cu yd. = 17 6  | —                | —                |
| ¾-in. aggregate @ 21s. 6d per cu. yd.    | —                | ¾ cu. yd = 18 0  | ¾ cu. yd. = 16 3 |
| Sand @ 25s. 6d. per cu. yd.              | ½ cu. yd. = 12 9 | ½ cu. yd. = 12 9 | ½ cu. yd. = 12 9 |
| Ordinary Portland cement @ 110s. per ton | 3½ cwt. = 18 0   | —                | —                |
| R.H. Portland cement @ 120s. per ton     | —                | 4½ cwt. = 27 0   | 5½ cwt. = 33 0   |
| Total per cubic yard, say                | 48 3             | 57 9             | 62 0             |

## Shuttering—

|  |                           |
|--|---------------------------|
| Item No. 8. Abutments: 2½ cu. ft. $\cup$ £95 per standard $\div$ 3 uses  | = 8s. 6d. per square yard |
| Item Nos. 9 and 11. Walls: 120s. per square $\times$ 1½% + 75 per cent. for strutting $\div$ 2 uses = 9s. 6d.              | "                         |
| Item No. 10. Arch: 120s. per square. One use only. Allow for salvage value (strutting included in centering) say = 8s. 6d. | "                         |

## COST ESTIMATE

323

**PLANT.**—Only equipment required for definite items in the bill of quantities is included in this section. Other items, such as scaffolding and cranes, are included under "General charges".

|   |   |             |
|---|---|-------------|
| Cofferdams: 300 lin. ft., 10 ft. deep = 3000 sq. ft.                            |   |             |
| Weight of steel sheet piling = 3000 × 20 lb. = 27 tons.                         |   |             |
| Cost of Sheeting: Depreciation  | £ s.  | £           |
| Carriage  | 4 10 per ton  |             |
|   | 6 0 " "   |             |
|   | -----   |             |
| 27 tons @   | 10 10 " "   | 284         |
| Hammer and compressor: Depreciation   |   | 75          |
| Carriage  |   | 45          |
| Erection, etc.  |   | 30          |
|   | s. d.   |             |
| Labour, power, etc. Driving   | 3 0 per sq. ft.                                     |             |
| Extract   | 1 6 " "   |             |
|   | -----   |             |
| 3000 sq. ft. @  | 4 6 " "   | 675         |
| Pumping: 2 men, 10 weeks @ £10 each   |   | 200         |
| Pumps, pipes, power, etc.   |   | say 150     |
|   |   | -----       |
| Total cost of cofferdams  |   | £1459       |
| Allocate 50 per cent. to excavation below water (Items Nos. 2 and 3)            |   |             |
|   | $= \frac{1459 \times 20}{2 \times 450} = 32s \ 6d.$ | per cu. yd. |
| Allocate 50 per cent. to abutment concrete (Item No. 4)                         |   |             |
|   | $= \frac{1459 \times 20}{2 \times 1050} = 14s.$     | per cu. yd. |
| Centering: Materials, 6000 cu. ft. @ £95 per standard                           |   | £ 3450      |
| Labour, 6000 cu. ft. @ 4s   |   | 1200        |
|   |   | -----       |
| Salvage, deduct, say  |   | 4650        |
|   |   | 450         |
|   |   | -----       |
|   |   | 4200        |
| Allocate to arch shuttering (Item No. 10) = $\frac{4200 \times 20}{720} = 117s$ |   | per sq. yd. |
| Concrete mixers: charge for one 14/10 mixer:                                    |   | £           |
| Depreciate £230, carriage £35, erect and dismantle £45                          |   | 310         |
| Batch boxes, etc.   |   | 30          |
| Petrol, 20 weeks @ £12 10s.   |   | 250         |
|   |   | -----       |
|   |   | 590         |
| Total charge for two mixers allocated to concrete (Items Nos. 4, 5, 6, and 7)   |   |             |
|   | $= \frac{590 \times 2 \times 20}{2125} = 11s.$      | per cu. yd. |

**GENERAL CHARGES.**—Under this heading are included all the costs of staff and equipment that should be allocated to the contract as a whole. The total of such costs is then expressed as a percentage of the labour cost.

|  |      |       |
|--|------|-------|
| Staff: Engineer on site, 1 year @ £1200  | £    | £     |
| Assistant engineer, 10 months @ £55  | 550  |       |
| Foreman, 44 weeks @ £16  | 704  |       |
| Timekeeper (£8), boy (£3), watchman (£5), mechanic (£10), store-keeper (£8) = 44 weeks @ £34 | 1496 |       |
|  |      | ----- |
|  |      | 3950  |

|   |   |                    |       |
|---|---|--------------------|-------|
| Site offices, etc.  | Site staff office . . . . .                               | £ 150              | £     |
|   | Clerk of Works' office . . . . .                          | 150                |       |
|   | Store, coverings, latrines . . . . .                      | 225                |       |
|   | Water . . . . .   | 150                |       |
|   | Barricades and lighting . . . . .                         | 75                 |       |
|   |   | --                 | 750   |
| Cranes · estimated charge for one crane on site for 9 months -- |   | £                  |       |
|   | · Depreciation · 20 per cent per annum on £1500 . . . . . | 225                |       |
|   | Other charges 10 per cent per annum . . . . .             | 113                |       |
|   | Carriage (£60), erect and dismantle (£150) . . . . .      | 210                |       |
|   | Staging and counterweight . . . . .                       | 120                |       |
|   | Fuel: 2 tons per week @ £6 for 30 weeks . . . . .         | 360                |       |
|   | (water included)  |                    |       |
|   | Craneman . 36 weeks @ £12 . . . . .                       | 432                |       |
|   |   |                    | 2920  |
| Scaffolding: Material, four @ £75 . . . . .                     |   | Two cranes @ £1400 |       |
| Labour, four @ £110 . . . . .                                   |   | 300                |       |
|   |   | 440                |       |
|   |   | --                 | 740   |
| Total of general charges . . . . .                              |   |                    | £8360 |
| On-cost on net labour . . . . .                                 | $\frac{8360}{7037} = 118$ per cent                        |                    |       |
| Add: Head office on-cost . . . . .                              | 10 " "  |                    |       |
| Small tools and consumable stores . . . . .                     | 5 " "   |                    |       |
| Insurance (excluding " Works ") . . . . .                       | 5 " "   |                    |       |
| Gross on-cost on net labour, say . . . . .                      | 140 per cent  |                    |       |

FINAL MAKE-UP.—In this section the net charges and profit (say, 10 per cent.) applicable to each item are combined to give the rate entered in the bill of quantities, and by extension and addition the total amount of the tender is determined.

| Item No | Description and Make-up           | Quantity   | Rate    | Total     |
|---------|-----------------------------------|------------|---------|-----------|
| 1.      | Excavation above water . . . . .  |            |         | £ s d.    |
|         | Labour . . . . .                  |            |         | 11 0      |
|         | On-cost . . . . .                 |            |         | 15 6      |
|         | Disposal . . . . .                |            |         | 3 0       |
|         |                                   |            |         | 29 6      |
|         | Profit . . . . .                  |            |         | 3 0       |
|         |                                   | 750 cu. yd | 32s. 6d | 1218 15 0 |
| 2.      | Excavation below water: . . . . . |            |         |           |
|         | Labour . . . . .                  |            |         | 16 0      |
|         | On-cost . . . . .                 |            |         | 22 6      |
|         | Disposal . . . . .                |            |         | 3 0       |
|         | Cofferdams . . . . .              |            |         | 32 6      |
|         |                                   |            |         | 74 0      |
|         | Profit . . . . .                  |            |         | 7 6       |
|         |                                   | 275 "      | 81s 6d  | 1120 12 0 |
|         | Excavation in hard soil . . . . . |            |         |           |
|         | Labour . . . . .                  |            |         | 31 6      |
|         | On-cost . . . . .                 |            |         | 41 0      |
|         | Disposal . . . . .                |            |         | 3 0       |
|         | Cofferdams . . . . .              |            |         | 32 6      |
|         |                                   |            |         | 111 0     |
|         | Profit . . . . .                  |            |         | 11 0      |
|         |                                   | 175 "      | 122s.   | 1067 10 0 |

## COST ESTIMATE

325

| Item No. | Description and Make-up   | Quantity    | Rate      | Total<br>£ s. d. |
|----------|---|-------------|-----------|------------------|
| 4        | Concrete in abutments (1 3 : 6) .<br><div style="margin-left: 20px;"> <i>s d</i><br/> Materials . . . . 48 3<br/> Labour . . . . 19 6<br/> On-cost . . . . 27 6<br/> Mixers . . . . 11 0<br/> Cofferdams . . . . 14 0<br/> <br/> Profit . . . . 120 3<br/> <hr style="width: 10%; margin-left: 0;"/> </div> | 1050 cu. yd | 132s. 3d. | 6943 0 6         |
| 5        | Concrete in walls (1 . 2 : 4) :<br><div style="margin-left: 20px;"> <i>s d</i><br/> Materials . . . . 57 9<br/> Labour . . . . 26 0<br/> On-cost . . . . 36 6<br/> Mixers . . . . 11 0<br/> <br/> Profit . . . . 131 3<br/> <hr style="width: 10%; margin-left: 0;"/> </div>                                | 230 "       | 144s. 6d. | 1661 15 0        |
| 6        | Concrete in arch (1 . 1½ : 3)<br><div style="margin-left: 20px;"> <i>s. d.</i><br/> Materials . . . . 62 0<br/> Labour . . . . 26 0<br/> On-cost . . . . 36 6<br/> Mixers . . . . 11 0<br/> <br/> Profit . . . . 135 6<br/> <hr style="width: 10%; margin-left: 0;"/> </div>                                | 710 "       | 149s od   | 5289 10 0        |
| 7.       | Concrete in parapet (1 . 2 . 4) .<br><div style="margin-left: 20px;"> <i>s d</i><br/> Materials . . . . 57 9<br/> Labour . . . . 38 6<br/> On-cost . . . . 51 0<br/> Mixers . . . . 11 0<br/> <br/> Profit . . . . 161 3<br/> <hr style="width: 10%; margin-left: 0;"/> </div>                              | 35 "        | 177s. 6d. | 310 12 6         |
| 8.       | Shuttering to abutments :<br><div style="margin-left: 20px;"> <i>s d</i><br/> Material . . . . 8 6<br/> Labour . . . . 9 0<br/> On-cost . . . . 12 6<br/> <br/> Profit . . . . 30 0<br/> <hr style="width: 10%; margin-left: 0;"/> </div>   | 345 sq. yd. | 33s. od.  | 569 5 0          |
| 9.       | Shuttering to walls, etc. .<br><div style="margin-left: 20px;"> <i>s d</i><br/> Material . . . . 9 6<br/> Labour . . . . 10 0<br/> On-cost . . . . 14 0<br/> <br/> Profit . . . . 33 6<br/> <hr style="width: 10%; margin-left: 0;"/> </div>  | 1500 "      | 37s. od.  | 2775 0 0         |

## REINFORCED CONCRETE BRIDGES

| Item No. | Description and Make-up                  | Quantity               | Rate      | Total    |           |           |
|----------|--|------------------------|-----------|----------|-----------|-----------|
|          |  |                        |           | £        | s.        | d.        |
| 10.      | Shuttering to arch :                     |                        |           |          |           |           |
|          |  |                        |           |          | <i>s.</i> | <i>d.</i> |
|          | Material . . . .                         |                        |           | 8        | 6         |           |
|          | Labour . . . .                           |                        |           | 9        | 0         |           |
|          | On-cost . . . .                          |                        |           | 12       | 6         |           |
|          | Centering . . . .                        |                        |           | 117      | 0         |           |
|          |  |                        |           | <hr/>    |           |           |
|          | Profit . . . .                           |                        |           | 147      | 0         |           |
|          |  |                        |           | 14       | 6         |           |
|          |  |                        |           | <hr/>    |           |           |
|          |  | 720 sq. yd             | 161s. 6d. | 5814     | 0         | 0         |
| 11.      | Shuttering to parapet :                  |                        |           |          |           |           |
|          |  |                        |           |          | <i>s.</i> | <i>d.</i> |
|          | Material . . . .                         |                        |           | 9        | 6         |           |
|          | Labour . . . .                           |                        |           | 12       | 6         |           |
|          | On-cost . . . .                          |                        |           | 17       | 6         |           |
|          |  |                        |           | <hr/>    |           |           |
|          | Profit . . . .                           |                        |           | 39       | 6         |           |
|          |  |                        |           | 4        | 0         |           |
|          |  |                        |           | <hr/>    |           |           |
|          |  | 400 "                  | 43s. 6d.  | 870      | 0         | 0         |
| 12.      | Reinforcement (supplied cut to length) : |                        |           |          |           |           |
|          |  |                        |           | <i>£</i> | <i>s.</i> |           |
|          | Material . . . .                         |                        |           | 63       | 0         | (average) |
|          | Labour . . . .                           |                        |           | 10       | 10        |           |
|          | On-cost . . . .                          |                        |           | 14       | 15        |           |
|          |  |                        |           | <hr/>    |           |           |
|          | Profit (10 per cent.) .                  |                        |           | 88       | 5         |           |
|          |  |                        |           | 8        | 15        |           |
|          |  |                        |           | <hr/>    |           |           |
|          |  | 115 tons               | £97       | 11,155   | 0         | 0         |
| 13.      | Finishes .                               |                        |           |          |           |           |
|          |  |                        |           |          | <i>s.</i> | <i>d.</i> |
|          | Material . . . .                         |                        |           | 1        | 6         |           |
|          | Labour . . . .                           |                        |           | 5        | 0         |           |
|          | On-cost . . . .                          |                        |           | 7        | 0         |           |
|          |  |                        |           | <hr/>    |           |           |
|          | Profit . . . .                           |                        |           | 13       | 6         |           |
|          |  |                        |           | 1        | 6         |           |
|          |  |                        |           | <hr/>    |           |           |
|          |  | 950 sq. yd             | 15s. 0d.  | 712      | 10        | 0         |
| 14.      | Filling :                                |                        |           |          |           |           |
|          |  |                        |           |          | <i>s.</i> | <i>d.</i> |
|          | Material . . . .                         |                        |           | 4        | 6         |           |
|          | Labour . . . .                           |                        |           | 3        | 0         |           |
|          | On-cost . . . .                          |                        |           | 4        | 3         |           |
|          |  |                        |           | <hr/>    |           |           |
|          | Profit . . . .                           |                        |           | 11       | 9         |           |
|          |  |                        |           | 1        | 3         |           |
|          |  |                        |           | <hr/>    |           |           |
|          |  | 5000 cu. yd.           | 13s. 0d.  | 3250     | 0         | 0         |
| 15.      | Preparing Surface .                      |                        |           |          |           |           |
|          |  |                        |           |          | <i>s.</i> | <i>d.</i> |
|          | Labour . . . .                           |                        |           | 3        | 0         |           |
|          | On-cost . . . .                          |                        |           | 4        | 3         |           |
|          |  |                        |           | <hr/>    |           |           |
|          | Profit . . . .                           |                        |           | 7        | 3         |           |
|          |  |                        |           | 9        |           |           |
|          |  |                        |           | <hr/>    |           |           |
|          |  | 950 sq. yd.            | 8s. 0d    | 380      | 0         | 0         |
| 16.      | Drainage (provisional) :                 | Item                   | —         | 500      | 0         | 0         |
| 17.      | Insurance of works (provisional) :       | Item                   | —         | 300      | 0         | 0         |
| 18.      | Concrete tests (provisional) :           | Item                   | —         | 75       | 0         | 0         |
| 19.      | Contingencies ;                          | Item                   | —         | 5000     | 0         | 0         |
|          |  |                        |           | <hr/>    |           |           |
|          |  | Total amount of tender | £49,013   | 0        | 6         |           |



### Construction Programme.

When a contract has been secured, the next steps are to order materials, arrange for plant to be sent to the site, and to prepare a detailed programme of all stages of the work from the possession of the site to the handing over of the completed structure. This programme, which is generally approved by the engineer or other authority, co-ordinates the delivery of materials, labour requirements, and use of plant, and also enables a check to be kept on progress. An example is shown in *Fig. 277*, which applies to the same contract as that for which the estimate in *Fig. 267* and the cost estimate in the preceding section were prepared. It differs in detail from the time-estimate chart, as small modifications seem desirable when each constructional stage is considered in detail. The notes on *Fig. 277* are self-explanatory.

### Maintenance of Traffic.

A method commonly adopted when replacing an existing bridge along the line of which traffic must be maintained is to retain the original structure, or a part thereof, to carry the traffic while a portion of the new bridge is constructed. Subsequently the traffic is diverted to the new work, while the old bridge, or the remainder thereof, is demolished and replaced. An advantage of this procedure, apart from obviating the necessity of providing a temporary structure, is that centering and other falsework need be provided only for the first portion of the new structure, so that it can be re-used on the succeeding portion. Co-operation between the contractor and the engineer is necessary to ensure that the design permits the construction to be carried out in two stages. When the foregoing method cannot be adopted a temporary bridge may be essential. The requirements may range from the provision of a way for pedestrians only, to the provision of a temporary bridge capable of carrying normal road traffic as in *Figs. 274* and *275*. In extreme cases a bridge of a semi-permanent nature may be required, but for such a major structure the design is usually prepared by the engineer. In the case of railway bridges, the railway engineers will generally provide drawings and details of all temporary works. A contractor is therefore usually concerned only with the design of the lighter forms of temporary bridges, the loading and clearances for which will be specified by the engineer and, in consultation with the latter, speed restrictions, loading limitations, and the arrangement and working of traffic signals will be established.

A temporary bridge, which is usually the first work to be put in hand, is commonly in timber, except over wide navigable rivers where the erection of a temporary steel bridge may be warranted. Groups of timber piles are sometimes driven as piers, adjacent piles in each group being braced together with bolted connections. Cross-heads support the main longitudinal runners. The latter, which may be either timber baulks or steel joists, span from pier to pier and carry the timber decking. Parapets are usually close-boarded, especially on the side adjacent to the new construction, to prevent crowds gathering to watch the work. The timbers should be designed to carry the loads as described later.

The main constructional problem is the erection of the piers. In slow-flowing streams it may be possible to drive piles from an anchored barge, but

REINFORCED CONCRETE BRIDGES

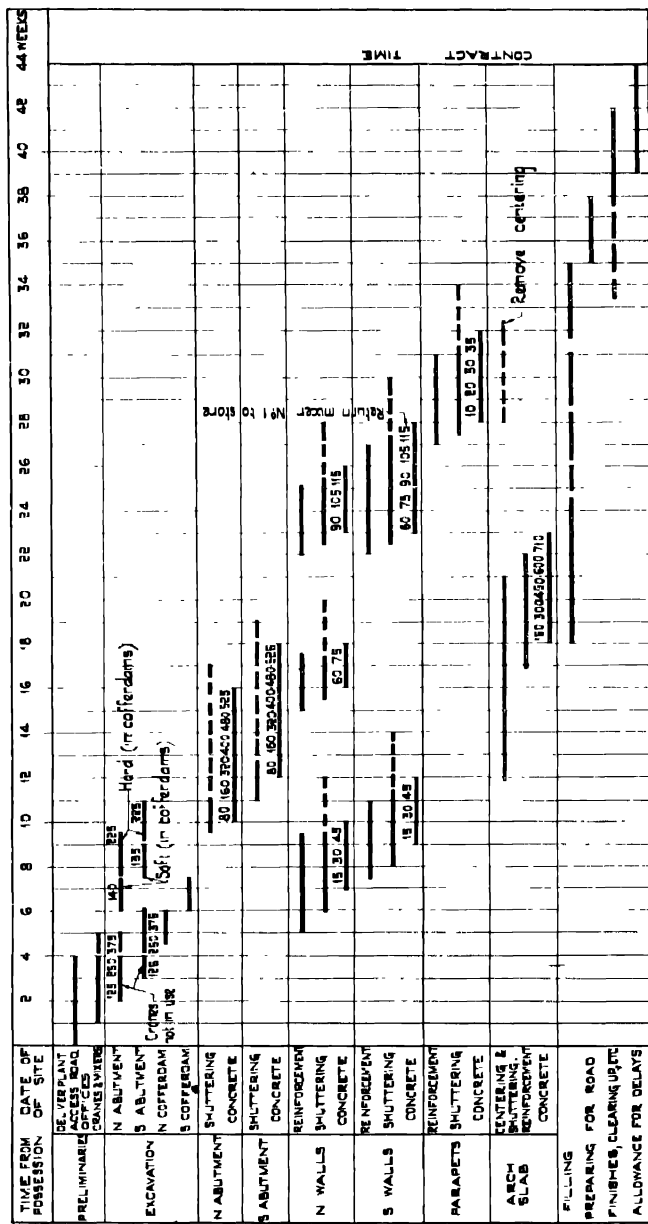

Fig. 277.—Construction Programme.

in other cases it is necessary to mount the pile driver on staging. One method of driving light timber piles is from a frame projecting in front of the staging being erected. The vertical guides for a winch-operated drop hammer are attached to the end of a cantilevered timber beam which is carried well back behind the last row of driven piles. The winch acts as a counterweight. For light temporary bridges the equipment described would be used to drive the piles forming the piers of the bridge, but for a large temporary bridge the piles capable of being driven by this equipment would be suitable only for the purpose of providing a staging upon which a larger pile frame could operate to drive the larger and longer piles required to carry the bridge.

The safe load on timber piles can be calculated approximately. On page 203 a formula is given for the load-carrying capacity of the permanent reinforced concrete piles, but for temporary timber piles the Dutch formula in the following form is applicable.

$$W = \frac{whn}{k(\bar{x} + R)}$$

in which  $W$  = the safe load in tons on a timber pile,  $w$  = the weight in tons of the drop hammer,  $h$  = the drop in inches of the hammer,

$$R = \frac{\text{weight of pile}}{\text{weight of hammer'}}$$

$n$  = number of blows per final inch of penetration, and  $k$  is a factor having the following values for timber piles :

|                         | In firm soil | In restless soil |
|-------------------------|--------------|------------------|
| With dolly . . . . .    | 6            | 8                |
| Without dolly . . . . . | 8            | 10               |

The value of  $k$  may be decreased by 10 per cent. if a single-acting steam-hammer is used and should be increased by 50 per cent. if the bulk of the load on the post is live load as in temporary bridges for vehicular traffic.

The safe concentric load in tons on a timber post is  $\frac{3}{8}bd$ , where  $b$  and  $d$  are the maximum and minimum cross-sectional dimensions in inches. This expression assumes that the ratio of the unbraced height to the least dimension does not exceed 15, and that the timber is seasoned pitch-pine, spruce, larch, elm, or beech. For yellow or red pine two-thirds of this value should be used, but an increase up to 50 per cent. can be made if ash, teak, or oak is used.

The safe concentric load on a timber pile considered as a column should also be calculated, and for this purpose the load is  $\frac{3}{8}bd\left(1 - \frac{L}{30b}\right)$ , where  $L$  (in inches) is two-thirds of the length of the pile embedded in the ground plus the length from ground level to the first effective brace.

The total safe uniformly-distributed load in tons (including the weight of the beam) on a timber beam is given by  $\frac{BD^2}{12.5l}$ , where  $B$  and  $D$  are the breadth and depth (in inches) respectively and  $l$  is the span (ft.). The expression assumes that (a) the beam is simply supported at both ends ; the load can be increased by 25 per cent. if the beam is continuous at one end, and by 50 per cent. if it is continuous at both ends ; (b) the load is uniformly distributed ; point loads must

be increased to their equivalent as uniform loads ; (c) the timber is sound seasoned pitch-pine, larch, or elm ; the load must be reduced by 50 per cent. for spruce, or red or yellow pine, but can be increased by  $33\frac{1}{3}$  per cent. if ash, beech, teak, or oak is used. The foregoing expressions are also suitable for the design of temporary timber gantries.

### Setting-out the Work.

It is important that the responsibility for the accurate setting-out of the works should be clearly defined in the contract documents, since corrections consequent upon errors may be very expensive. The general conditions of contract issued by the Institution of Civil Engineers are implicit on this point insofar as the contractor is responsible for the correctness of the position, levels, dimensions, and alignment of the works, and is required to make good at his own expense any errors unless the error is due to incorrect data supplied in writing by the engineer. The fact that the setting-out has been checked and passed by the engineer does not usually relieve the contractor of his responsibility if errors should subsequently be found. It is normally incumbent upon the contractor to provide instruments and attendance required in setting-out the works.

The position of the principal reference lines and level-pegs should be selected so that, if possible, they can remain in an accessible position throughout the work. If original reference points have to be disturbed during the work, the setting-out of the replacement points should be done with great care and checked before the original points are removed or covered. Bench-marks, site-rails, pegs, or other setting-out marks should be protected from damage, wear, subsidence, vibration, or other effects likely to cause inaccuracies. Where existing Ordnance Survey bench-marks are not used as a datum for levels, one or more level-pegs consisting of a small steel plate embedded in the top of a block of concrete should be arranged at known levels at convenient points, preferably just outside the area of the work. The principal reference line for a bridge is preferably the longitudinal centre-line, and this should be established by at least one point at each end of the bridge. Such points should be readily visible, and in such a position as not to be disturbed until at least the abutments have been built, after which it may be possible to transfer the reference points to the latter. If the bridge is on a curve the tangent points of the curve should be established by pegs, and other pegs provided to define the direction of the tangents.

The procedure for setting-out the foundations for a single-span bridge is as follows. Parallel to the face of the abutments the position for a transverse reference line is selected. In the case of a non-skew bridge this line is at right-angles to the longitudinal centre-line, and if the bridge is to be over a road or railway it is advantageous for the transverse setting-out line to intersect the longitudinal centre-line at the centre of the span. This condition is shown in *Fig. 278*, where ABCDE, etc., is the plan of the pier or abutment foundations, and  $X_1OX_2$  is the given centre-line of the structure, and  $Y_1OY_2$  is the transverse reference line. Where it is inconvenient to establish the point O at the centre of the bridge, the line  $Y_1OY_2$  might be placed, say, 3 ft. from one abutment face. From the drawings the co-ordinates of B, C, D, etc., are determined, that is,  $bB$  and  $1B$ ,  $dC$  and  $3C$ ,  $cD$  and  $4D$ , etc.



**Excavation and Disposal of Material.**

Excavation for bridge foundations is executed by hand or by machine or by a combination of both methods. Commonly the amount of excavation is small ; this factor, and also the occurrence of steep banks and excavating below water level, limit the economy and convenience of machines. If, however, a machine is employed on ancillary works, such as the cuttings and embankments in the approaches, it may be useful for the more accessible parts of the excavation of the foundations for the latter. Often one or more cranes are installed for distributing the concrete and handling other materials, and if they are erected early enough they can be used for handling excavated material in skips. The skips are filled by hand either in open excavation or within timbered holes or cofferdams, and are emptied directly on to a dump or into lorries. Cranes can also be adapted to work a grab which can remove the bulk of the material within

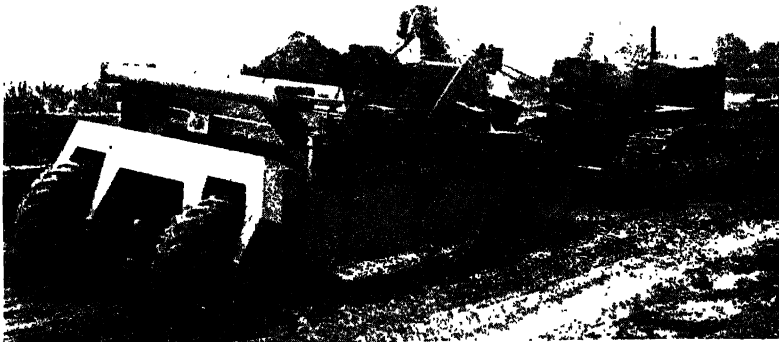

**Fig. 279.- Superficial Excavation with a Scraper-Loader.**

a timbered excavation, the earth in the less accessible parts being dug and loaded by hand into the grab or skip.

Where the quantity and accessibility of the excavation warrant the use of a machine, the type of the latter depends on the nature of the soil, the shape of the excavation, and the relation between the working position of the machine and the bottom of the excavation. Many machines are readily convertible from one type to another and are useful where the character of the excavation for the abutments may vary within a short distance. Thus a single machine may be employed as a shovel, trencher, drag-line, or grab, as well as being converted into a crane.

For superficial excavation to level a site for an approach road a skimmer can be used. The bucket, travelling on a horizontal boom, runs outwards from the machine for a distance of about 12 ft., making a horizontal cut a few inches deep. At the end of the travel the boom is raised, swung over the lorry, and the contents of the bucket discharged therein. A scraper-loader (*Fig. 279*) may

be used for the same purpose. The hinged bottom of the body opens downwards and the forward cutting edge cuts a few inches into the ground while the machine is being drawn by a tractor. The earth piles up into the body which, when filled, is hauled to the disposal area. This machine is most useful when the dump for excavated material is adjacent to the site of the excavation; otherwise a skimmer loading into lorries may be preferable. Bulldozers are used for similar levelling purposes when the surplus soil has to be transported only a few feet.

When bulk digging is required the machine or the digging equipment attached to it must work in such a position that it will be able to get away on completion of the excavation. For digging into the face of a bank in the dry, a mechanical shovel (*Fig. 280*) can be used. This works with a forward and upward motion, and machines of medium capacity can cut into a bank 20 ft. high or to a depth of about 7 ft. 6 in. below the standing level of the machine and at a distance of about 25 ft. from the centre of the machine. Shovels will dig in most ground except conglomerates and rock, but the latter, when broken by blasting or other-

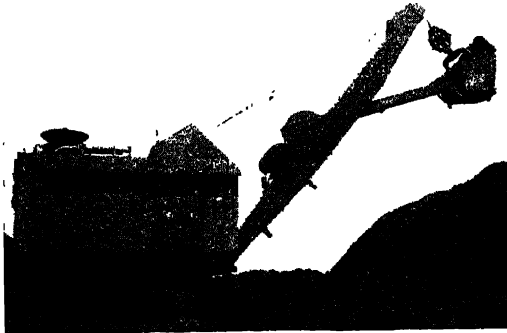

**Fig. 280.—Removing Soil with a Mechanical Shovel.**

wise, is often loaded into lorries by a shovel. If the ground is firm enough, digging by shovel leaves an almost vertical face; its use is mainly, therefore, in cutting away a bank for the upper part of an abutment or preparing a cutting for an approach road.

A trencher (*Fig. 281*), which is used for digging below ground to depths greater than a shovel can reach, say, 20 ft. for a machine of medium capacity, can also leave a vertical face in firm ground and can work in similar ground to a shovel. It operates with an inwards and upwards motion and is used for either digging trenches of limited width or for wide excavations, the face of the cut being almost at the edge of the machine. The machine is useful in digging narrow foundations for wing walls or for the lower part of an open abutment excavation without timbering or cofferdams.

A drag-line works in soft material either in the dry or under water and operates with a downwards, inwards, and upwards motion. Although capable of digging to, say, 25 ft. below the standing level of the machine, with the cut commencing 60 ft. from the latter, a drag-line can also be used for superficial

excavation. The shape of the excavation left by a drag-line is a trough with sloping sides, and this machine may be suitable for abutment excavation when timbering is not resorted to, although much more ground may be taken out than is essential, necessitating subsequent back-filling.

For machine digging within timbered excavations or cofferdams, a grab suspended from the boom of a drag-line machine or from the jib of a crane can be employed. The grab must be designed for the type of digging encountered, and a heavy-duty excavating grab is generally used having capacities up to, say, 1 cu. yd. If working in sand a lighter grab can be used. Excavation by grab is most suitable for digging for mid-river piers if the equipment can be arranged so



Fig. 281.—Trench-Digging Machine.

that the grab with its load can be lifted out of the excavation and discharged into a lorry or other wagon in a single operation. If the grab is operated from a crane in a fixed position, and if the river is wide, the crane may be unable to reach lorries standing on the banks, and in this case discharge into barges can often be arranged.

Dredging usually requires special equipment, although drag-lines operating from the bank may be suitable in some cases.

The capacities of shovels, buckets, grabs, or other equipment for mechanical excavation are given by the manufacturers, often together with the speed of working. Rarely on construction work can these maximum outputs be realised since, apart from delays due to breakdowns, limitation of space, and other



circumstances, the rate of excavation by machine is affected by the speed with which lorries or wagons can be marshalled, filled, and dispatched.

The equipment selected for removing excavated material depends on the distance from the excavation to the dump and the amount to be handled. If it is merely a case of transporting surface material from one place to adjacent hollows, a bulldozer would serve the purpose if the area to be levelled is sufficiently large to warrant bringing this equipment on to the site. Otherwise hand-filled crane-skips or small lorries are suitable. When similar levelling is required but the place of deposition is many yards away, a scraper-loader is suitable for large quantities, or hand-filled crane-skips (if within reach of the crane), dumpers, or lorries may be used for smaller amounts of material. When the dump is some distance from the site, for all types of excavation the material is most economically transported in lorries filled by hand, from crane-skips or grabs, or directly by mechanical shovels, trenchers, or drag-lines. Only in the case of very large quantities might it be economical to lay rail-tracks of either narrow or standard gauge.

So many variants enter into the excavation and disposal of spoil, and so many and varied are the types of equipment and methods available, that the foregoing remarks can be considered only as generalisations. When a contract is being planned, the nature of the excavation problem, allied with the other constructional operations, will suggest one or more likely ways of carrying out the work. It then remains for the contractor to consider the relative cost and speed of each of these ways and select his method and equipment accordingly.

### **Timbering, Cofferdams, and Dewatering.**

In bridge construction, timbering and keeping the excavations clear of water present few problems differing from those encountered in other types of work, except that often the foundation levels of land piers or abutments are below water level and close to a river. Thus pressures on timbering are nearly always hydrostatic and considerably in excess of the pressures due to dry earth; consequently the timbering must be much more substantial than for the latter condition. Also the flow of water may be more copious than is the case with normal ground water, and as a result pumps of greater capacity are necessary. For this reason, also, well-point dewatering systems are not always suitable for this class of work.

Land piers and abutments may be sufficiently deep below the water level to necessitate the provision of cofferdams consisting of watertight sheeting driven into an impermeable stratum. Cofferdams are nearly always necessary for river piers, but when the foundation level exceeds 40 ft. below water level it is more usual to provide a form of cylinder foundation, open caisson, or pneumatic caisson. Caissons or cylinders are also used where cofferdams are impracticable owing to boulders or other obstructions preventing the driving of sheet piles, or due to an impermeable stratum not being met at a reasonable depth. Descriptions of some cofferdams are given in Chapter VIII. The design and construction of such temporary works, together with cylinders and caissons, are so dependent on circumstances that the subject cannot be adequately dealt with in this volume, and for fuller information the reader is referred to books dealing with the design and construction of these works.

### Foundation Construction.

Some examples of the construction of bridge foundations are given in Chapter VIII, but the following additional observations may be useful.

When the excavation for a reinforced concrete foundation is completed the bottom should be blinded with a layer of concrete to provide a clean working surface. The engineer usually specifies the thickness of and proportions for this layer but even if the drawings do not call for a blinding layer it is to the contractor's advantage to provide one. In this case, the engineer should be consulted so that the strength of the concrete will be sufficient to resist the bearing stresses for which the foundation is designed. The thickness of the blinding layer, which must be taken into consideration when the depth of the excavation is determined, should not be less than 2 in., nor should the concrete be leaner than 1 part of Portland cement to 8 parts of all-in aggregate. The nature of the ground and the slope of the foundation will determine the thickness required. Friable earth would require a greater thickness than gravel, but seldom would more than 6 in. be required. Any reinforcement placed on the blinding layer should be separated therefrom by a space equal to the minimum specified cover.

When placing concrete in excavations it is necessary to ensure that water does not come into contact with the freshly-placed concrete, unless suitable measures have been taken for the concrete to be placed under water. Adventitious contact with water will seriously reduce the strength of the concrete and thus pumping must be maintained until the final set of the concrete has taken place. Subsequently the water may be beneficial to the maturing of the concrete, but if the water contains material in suspension it should not be allowed to cover the temporary face of an incomplete foundation, since undesirable materials may be deposited, and these may be very difficult to remove before placing the next layer of concrete. If the ground water is likely to be harmful to concrete, the engineer will specify protective measures, which may include the use of high-alumina cement.

The concrete must be protected from falling earth, and from any disturbances during the driving of piles or sheeting, or during the withdrawal of sheet piling. In work that is difficult of access it is cheaper to leave shuttering or timbering in position than to make an attempt to remove it. If the contractor so proposes, he should obtain the engineer's approval since any cavity formed upon decay of material may have an adverse effect on the stability of the foundations or on the surrounding ground.

The principles of making and driving precast reinforced concrete piles in wharf and similar construction apply to bridge construction, although site conditions are sometimes more onerous, as when piles have to be driven from a barge or within cofferdams, or where inclined piles are required under an abutment. It is not always possible in bridge construction to have the pile-casting yard immediately adjacent to the driving position. This is especially so in the case of piled river piers, for which suitable arrangements must be made for transporting the piles to the driving frames. Such arrangements may include a temporary staging supporting a rail track upon which the piles are transported on bogies or, if the piles are not excessive in length and weight, it may be possible to transport them by crane. In fairly calm water, transport by pontoon may be practicable.

Light concrete sheet piling that may be required for wing walls or for anti-scour purposes at the faces of abutments or piers can usually be driven by a hammer suspended from one of the cranes provided for general handling purposes. In some cases, cofferdam sheeting cut off at the requisite level may be left in place to act as a protection against scour.

#### **Filling.**

Earth filling behind abutments and wing walls or between the spandrel walls of bridges must be deposited with care and only selected material, usually approved by the engineer, should be used.

Precautions are necessary to ensure that the placing of the filling does not produce undesirable stresses in the structure. For example, unless abutments have been designed accordingly, no filling should be placed behind the abutments during construction unless they are temporarily strutted, or until the deck has been constructed and is capable of acting as a strut. The filling behind retaining walls should not be placed until the concrete has attained sufficient strength to resist the stresses produced by the action of the filling. When the engineer does not specify otherwise, the period that should elapse between depositing the concrete and the filling should not be less than four weeks with ordinary Portland cement and ten days with rapid-hardening Portland cement, assuming that no frosts have occurred during this time. The earth should be deposited in layers up to 12 in. deep evenly spread along the back of the wall, and should not be dropped from a height. When a rubble backing is used, it should be placed to the required thickness in contact with the wall in advance of the earth filling. If large rubble is used it is advantageous to pack this by hand in such a way that it is largely self-retaining. When placing filling over arches between spandrel walls, the engineer's requirements should be asked for (if they are not specified) and followed, as serious over-stressing of the structure can result from haphazard or seemingly reasonable filling procedures. The consolidation of the filling while it is being deposited is important if excessive future settlements are to be avoided. For this reason, deposition in thin layers and the consolidation of one layer before the next is placed is usually advocated.

For small areas consolidation can be economically effected by hand-tampers or hand-drawn rollers, but with increase in the amount of filling (and in bridge construction the amount is often comparatively large) power-operated rollers (steam or diesel) are used for open sites and power-tampers for the less accessible positions. Sheepsfoot rollers drawn by tractors are also suitable for consolidating filling in approach roads behind the abutments. Particularly behind wing walls and abutments, there is a special need for consolidation to avoid an excessive depression where the road passes from the comparatively unyielding structure on to the filling. The Ministry of Transport recommends some form of soil stabilisation for the consolidation of such fillings.

## CHAPTER XIV

### STAGING, CENTERING, AND SHUTTERING

TERMS—SHUTTERING—STAGING AND CENTERING—EXAMPLES OF SHUTTERING  
AND CENTERING

THE terms shuttering, staging, and centering are often used ambiguously, and it may therefore be useful to give definitions which appear to have adequate justification, and which are used in the following.

Shuttering is the boarding, sheeting, or boxing, together with all necessary clamps and stiffeners, forming the box into which the concrete is placed. The term "moulds" should be restricted to the boxing, whether of timber or steel, within which precast concrete units are formed.

Staging is defined as the temporary foundations and vertical supporting members, together with horizontal and diagonal bracing, necessary to support the shuttering at the desired height above the ground.

Centering means the curved members or trusses supporting the sheeting or boxing to arches or curved beams.

The subject of shuttering and staging is a vast one, and it is proposed here to deal only with aspects of the problem which have special application to bridges.

The engineer should be aware of the type of staging which is most likely to be easily erected at the least cost. He must be able to recognise the special cases where staging from a river bed is hazardous, if not almost impossible, as considerations of this kind may influence the whole design of a structure. He must also be able to distinguish between a satisfactory staging project and an unsatisfactory one, because he will ultimately be required to approve or reject, within the limits of the specification and conditions of contract, the method proposed by the contractor. This kind of experience is difficult to obtain. In order to enable an engineer without much experience to grasp the nature of the staging problem, he should endeavour to think carefully of the following case and try to decide how he would deal with it if he should encounter this type of situation for the first time. "A single 60-ft. span earth-filled closed-spandrel barrel arch is to be constructed over a fast-flowing mountain river with a normal depth of water of 6 ft. The soffit of the arch slab at the crown is to be 21 ft. above the gravelly and rocky bed of the river, with rock never more than 12 in. below the bed. How should the staging be designed in such a case?"

The problem is mainly to ascertain how to construct the temporary foundations on which the staging is to be supported and to erect on the foundations a structure which is not likely to be swept away by the river in flood. Clearly it is impossible to drive temporary piles because of the rocky nature of the foundations, and for a small bridge of this type any expensive or ambitious methods are not warranted. The conclusion will probably be reached that the information

given is hardly sufficient to decide on the most economical treatment. It is possible, for instance, that bags filled with cement might be placed on the river bed, providing a support for tubular steel scaffolding closely spaced and adequately cross braced. Such a method was, in fact, employed with success recently in strengthening an old stone arch bridge which was liable to collapse. An alternative would be to erect structural steel lattice trusses, supported from the concrete abutments, which could be used to provide a support for the shuttering to the arch soffit by means of suspension bolts. The trusses could be designed to form the reinforcement of the arch slab, and would ultimately be concreted in with the slab.

### Shuttering.

Shuttering in bridge works differs little from that in other structures but, as the face of the concrete may be exposed to the elements for a hundred years or more, great care must be taken to obtain a good finish free from honeycombing and other blemishes. This can be obtained by the use of dressed tongued and grooved shecting and boarding, and occasionally by the use of a shutter lining in order to prevent fins between the boards. Columns and walls which are not exposed to the elements may, by careful touching up, be made satisfactory, even though the stripped surface may appear unsightly, but such treatment of concrete exposed to the effects of wind and weather will soon result in a structure possessing a very poor appearance.

Shuttering is usually constructed with yellow pine, either Norwegian or American. White pine appears to be suitable for mouldings, parapet plinths, etc., and makes a satisfactory lining, but it is too soft and has too little strength for general use. Boarding 1 in. to 2 in. thick is generally used, according to the requirements of strength and the general design of the shuttering, but in bridge works thicknesses of boarding below  $1\frac{1}{2}$  in. are very rare. Where a specially smooth finish is required, it is usual to line the shuttering with a smooth hard wall-board. The engineer who wishes to obtain a really good looking finished structure will inspect with care the contractor's shuttering proposals, as there are nearly always some levels where the line left by the boarding could utterly destroy the æsthetic effect. Shuttering for beams should be designed for early stripping of the sides, so that the concrete at an early stage may, if desired, be rubbed down with a carborundum stone and water or, occasionally, with a wooden float. The general design of the shuttering must be governed by the stopping-off planes of the concrete, and the latter should always be carefully specified by the engineer, taking into consideration the final appearance of the structure.

Tying wire should not be permitted as a means of preventing movement of the shuttering during concreting, as the ends of the wire which are left are liable to form rust spots even though they may be cut back, say,  $\frac{1}{4}$  in. into the concrete and the surface then made good. Bolts may be used through cardboard sleeves and, after concreting, the bolts withdrawn and the holes subsequently filled to within 1 in. of the surface; the last inch should be filled with a mixture of cement, sand, and fine aggregate to match the remainder of the concrete surface, and this requires great care to prevent a patched appearance. The bolts should not be more than  $\frac{5}{8}$  in. diameter in order to avoid large holes.

Concrete in piers and columns should be carried out in lifts to suit the general

lines of the bridge, and external beams should, wherever possible, be concreted for the full depth in a single operation.

Climbing shuttering may be economical for high piers, but should not be allowed unless it can be made to produce results which conform with the general æsthetic requirements of the finished structure.

The contractor may occasionally have a special scheme in mind for the shuttering which might not suit the finished appearance required, and it must be remembered that the former cannot be expected to know the requirements unless they are stated clearly in the specification. The engineer should go over the shuttering problems with the contractor's agent at an early stage in the work so that there can be no ambiguity about his intentions, and if the specification has not provided for certain requirements these points should be dealt with immediately. A non-staining shutter oil should always be specified.

The following strength requirements are usual for temporary shuttering and staging.

|   |                               |
|---|-------------------------------|
| Superimposed load during construction   | 80 lb. per square foot        |
| Weight of concrete  | 144 lb. per cubic foot        |
| Side pressure of wet concrete per foot depth  | 125 lb. per square foot       |
| Safe bending stress for yellow pine, spruce, and fir  | 1200 lb. per square inch      |
| Safe shearing stress  | 200 lb. per square inch       |
| Crushing against the grain (bearing)  | 400 lb per square inch        |
| Modulus of elasticity   | 1,200,000 lb. per square inch |
| Maximum allowable deflection for sheeting   | $\frac{1}{16}$ in             |
| Maximum allowable deflection for joists (but half the live load may be used for the latter in calculating deflection) | $\frac{1}{16}$ in.            |

The resident engineer should carefully check all shuttering either from the contractor's preliminary sketches or, if these are not available, as it is being erected. The design of staging and shuttering is quite simple so far as calculations for strength are concerned, the main difficulty being to find an arrangement which will be the most economical. The considerations governing economical design are similar to those for a finished structure, but the salvage value of the material is an important matter, as also is the ease with which stripping can be accomplished.

All wedging should be done with hardwood, as it is most desirable to avoid any movement when the shuttering has been wedged up prior to concreting.

#### Staging and Centering.

The treatment of the staging and centering for a bridge is of the utmost importance, and the problems involved are closely related to the design of the bridge. The difficulty of constructing piers or posts in a river will cause long spans and wide spacing of vertical members, or even their omission in a carefully considered design, and this problem will probably have been solved by the engineer in designing the structure. The economical treatment of the staging may make a considerable difference in the cost of a bridge, but, whilst the contractor may have considerable difficulties to overcome, the structure is only a temporary one and a variety of solutions may be equally applicable. The engineer must seek a more studied and ideal solution of his problem, as the bridge is intended to serve for many years, but the temporary work offers much scope for improvisation as it is removed before the bridge is completed.

During recent years an increasing use has been made of tubular metal scaffolding, and numerous fittings have been designed to provide for almost every

type of work. The poles are provided with sole-plates of various sizes, and clips for making connections between vertical and horizontal members and for joining two vertical members together where extra height is required. These poles are more reliable than timber, and they may be used over and over again as they are not liable to such a rapid rate of deterioration as timber. The price of tubular poles appears to be high when compared with other manufactured steel products, but the cost of hiring them does not compare unfavourably with the alternative cost of erecting staging with timber.

### Examples of Shuttering and Centering.

There are four methods of constructing staging and centering :

(1) Propping from the ground or river bed, including the construction of sufficient temporary foundations.

(2) Supporting temporary arches or girders from holes or rests on the piers.

(3) Supporting the shuttering from a steel framework which, with supplementary mild steel bars, can be embodied in the final structure as permanent reinforcement and which will be concreted in with the main bridge members.

(4) Erecting trusses or girders above the new bridge level and suspending the shuttering from this by means of tie bars and suitable bearing joists.

The first method is the most generally used and is applicable where the height of the bridge deck above the bed of the stream is not excessive—this includes most small and moderate sized bridges. The term " excessive " is, of course, a relative one, but may be defined here as being applicable to structures where the height is greater than half the span of small bridges up to 60 ft. and one-quarter to one-third for larger spans up to, say, 200 ft. Spans greater than 200 ft. are the exception in this country.

An interesting example of Method (1) was provided during the construction of Craighall bridge, on the Perth-Blairgowrie road. This bridge is an open-spandrel arch, consisting of two arch ribs having a span of 155 ft., supporting a decking 30 ft. wide inside parapets. The centres of the two arches are 26 ft. apart, with a rib depth of 34 in. at the crown and 54 in. at the springing, the width being 78 in. The general arrangement is shown in *Fig. 156*. The bridge spans over the river Ericht, which forms a shallow stream in dry weather but is liable to rise suddenly during a rainy period. The bed of the stream is rocky and the main abutments rest on the rock just below the surface of the ground. The staging to the main arches was carried out with tubular steel scaffolding ; the construction is shown in *Figs. 282 and 283* which, together with the following description, illustrate the methods used.

Concrete dwarf piers about 6 ft. long at 19-ft. 6-in. centres were constructed on the bed of the stream during a comparatively dry period, and on these, concreted into suitable pockets, were placed three rows of rolled steel joists. Resting on the joists were cross joists of timber at about 4-ft. 9-in. centres, and from this substructure was raised the superstructure of steel poles which were also spaced at 4-ft. 9-in. centres. Adequate cross bracing and diagonal bracing were provided, and the top layer of horizontal members supported the sole-plate to the main arches. The pier shuttering was supported from the arch ribs, and the shuttering to the cross-beams and the deck slab was in turn supported by the concrete piers.

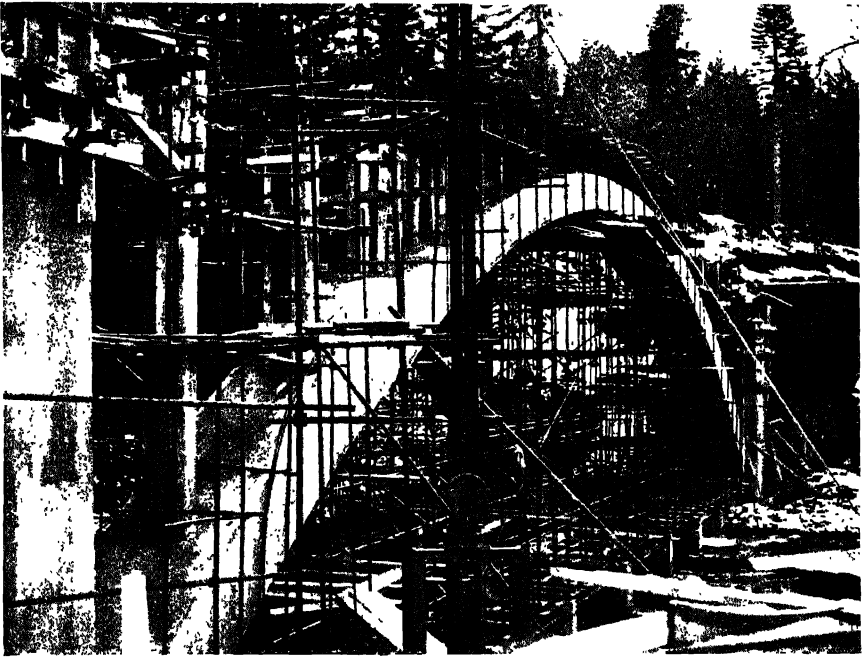

Fig. 282.

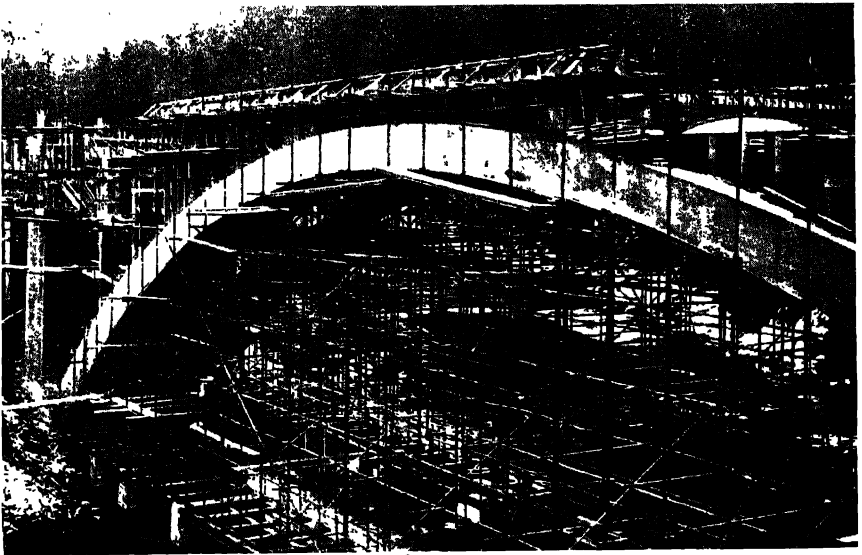

Fig. 283.  
Arch Staging supported on River Bed.



The engineer, when considering the most suitable scheme for the main span, had to decide whether the staging method actually used would be cheaper or more appropriate than a light steel trussed arch which might have been erected to support the shuttering, and which could have formed the reinforcement for the concrete arch ribs. In this instance, however, there was little difficulty in providing suitable temporary foundations for the staging, and orthodox methods were therefore satisfactory.

The construction at the bridge shown in *Fig. 284* provided a good example of Method (2), and is illustrated in *Figs. 285 to 287*. This bridge provided a very difficult problem for both engineer and contractor, and reference to *Fig. 284* will show the difficulties of the site. The bridge is constructed on a curve and gradient, provision is made for superelevation, and the roadway is approximately 76 ft. above the valley of the river near the deepest point. The solution of the constructional problem is seen in the illustrations.

*Fig. 285* shows some of the piers completely constructed with scaffolding around them, and steel trussed girders in position on three spans to support the deck beam and slab shuttering. The bridge consists of seven main spans, each approximately 67 ft. long with a deck width between parapets of 40 ft. The superstructure consists of curved beams at approximately 6-ft. 8-in. centres, and the height from the ground to the lowest point of the beam soffit is 64 ft. at the deeper portions of the valley. The river, when not in flood, has rarely more than a few feet depth of water and has a gravelly bed. There were considerable difficulties during the construction of the piers because of the widely varying levels of the shale subfoundation on which it was hoped to construct all the foundations. The contractor supported the deck shuttering on steel trusses resting on rolled steel joist bearing beams, which were in turn supported by steel joists resting in pockets left in the hollow bridge piers. The beam soffits and sides, as well as the decking, were supported from the steel trusses, and *Fig. 286* shows the construction at the stage where the shuttering for the beams was ready for concreting. *Fig. 287* shows one span completed and the process of dismantling the steel trusses in progress. The constructional difficulties need not be over-emphasised in work of this kind, and the critical reader might think that this case was one where steel girders might have been used to support the shuttering and ultimately built into the finished structure. Due, however, to the large curvature of the bridge such a course would have produced many additional designing difficulties and would undoubtedly have increased the cost of the finished structure.

An interesting example of Methods (3) and (4) was demonstrated during the construction of Dinnet bridge over the river Dee about forty miles west of Aberdeen. At this point the river is not very wide, and during flood rises rapidly and is extremely fast flowing. The hazardous nature of any effort to attempt to stage from the river bed was clearly evident, even if such a course was reasonably possible, and was proved a few years later during the construction of another bridge over a river with similar but less severe characteristics. In this later instance very dangerous floods were experienced which gravely endangered the staging, and also rose above the level of the cofferdams during the construction of the abutment foundations, and indicated clearly the necessity for the special type of construction adopted previously at Dinnet bridge. The construction is illustrated by *Fig. 288*, and the way in which the contractor used every

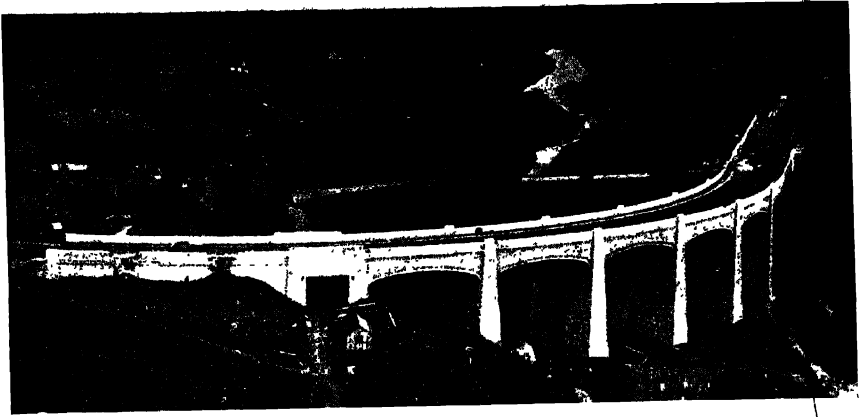

Fig. 284.

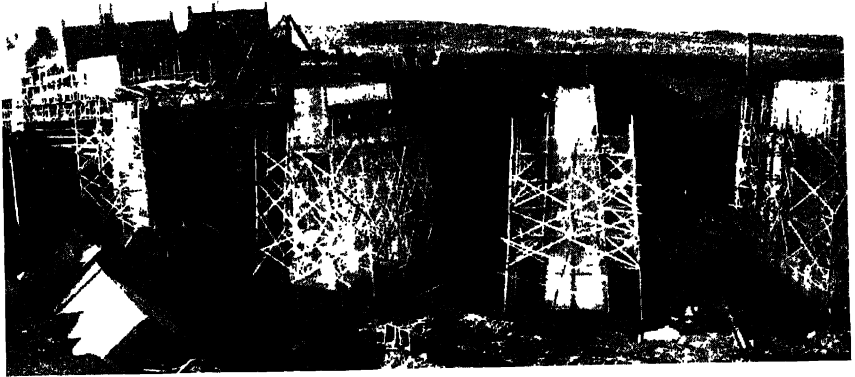

Fig. 285.—Steel Girders carrying Beam and Slab Shuttering.

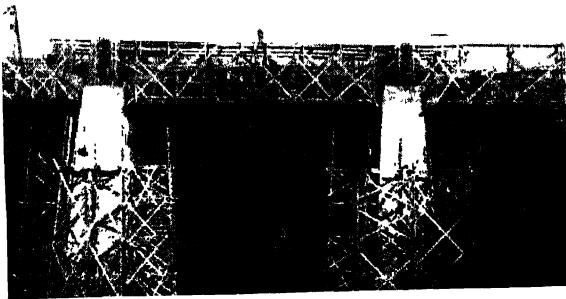
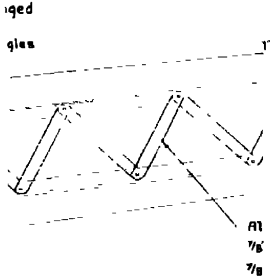

Fig. 286.—Detail of Girders.

FIG. 288.

[SEE OVERLEAF FOR FIG 289]



SECTION ON LINE A-A.

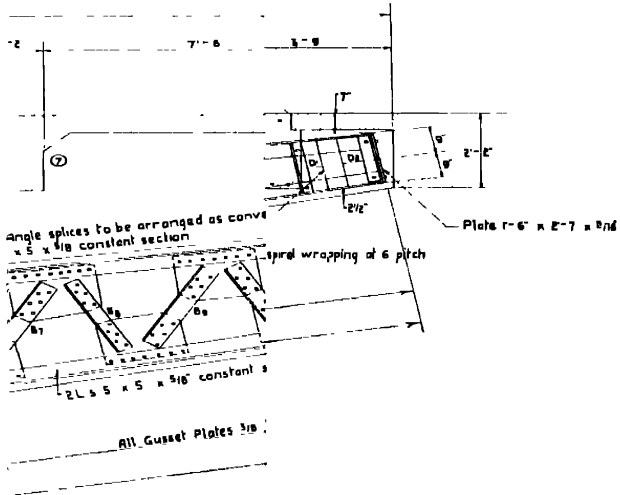

PK NOT TO BE PRINTED

embers.

FIG. 289.

SCHEDULE OF REINFORCEMENT.

| MEMBER       | No OFF | BAR | No IN EACH | TOTAL No | DIA | LENGTH | BENDING | REMARKS |
|--------------|--------|-----|------------|----------|-----|--------|---------|---------|
| BEAMS 1 & 2. | 4.     | a   | 1          | 1        | 1#  | 9'-9"  |         |         |
|              |        | b   | 6          | 1#       | 6#  | 17'-8" |         |         |
|              |        | c   | 1          | 1        | 1#  | 17'-8" |         |         |
|              |        | d   | 1          | 1        | 1#  | 17'-0" |         |         |
|              |        | e   | 2          | 1        | 2#  | 17'-6" |         |         |
|              |        | f   | 1          | 1        | 1#  | 17'-0" |         |         |
|              |        | g   | 4          | 1#       | 4#  | 15'-5" |         |         |
|              |        | h   | 1          | 4        | 4#  | 15'-0" |         |         |
|              |        | i   | 4          | 1#       | 4#  | 14'-9" |         |         |
|              |        | j   | 1          | 4        | 4#  | 14'-9" |         |         |
|              |        | k   | 1          | 1        | 1#  | 14'-0" |         |         |
|              |        | l   | 1          | 1        | 1#  | 14'-0" |         |         |
|              |        | m   | 1          | 1        | 1#  | 14'-0" |         |         |
|              |        | n   | 1          | 1        | 1#  | 14'-0" |         |         |
|              |        | o   | 1          | 1        | 1#  | 14'-0" |         |         |
|              |        | p   | 1          | 1        | 1#  | 14'-0" |         |         |
|              |        | q   | 1          | 1        | 1#  | 14'-0" |         |         |
|              |        | r   | 1          | 1        | 1#  | 14'-0" |         |         |
|              |        | s   | 1          | 1        | 1#  | 14'-0" |         |         |
|              |        | t   | 1          | 1        | 1#  | 14'-0" |         |         |
| u            | 1      | 1   | 1#         | 14'-0"   |     |        |         |         |
| v            | 1      | 1   | 1#         | 14'-0"   |     |        |         |         |
| w            | 1      | 1   | 1#         | 14'-0"   |     |        |         |         |
| x            | 1      | 1   | 1#         | 14'-0"   |     |        |         |         |
| y            | 1      | 1   | 1#         | 14'-0"   |     |        |         |         |
| z            | 1      | 1   | 1#         | 14'-0"   |     |        |         |         |
| aa           | 1      | 1   | 1#         | 14'-0"   |     |        |         |         |
| ab           | 1      | 1   | 1#         | 14'-0"   |     |        |         |         |
| ac           | 1      | 1   | 1#         | 14'-0"   |     |        |         |         |
| ad           | 1      | 1   | 1#         | 14'-0"   |     |        |         |         |
| ae           | 1      | 1   | 1#         | 14'-0"   |     |        |         |         |
| af           | 1      | 1   | 1#         | 14'-0"   |     |        |         |         |
| ag           | 1      | 1   | 1#         | 14'-0"   |     |        |         |         |
| ah           | 1      | 1   | 1#         | 14'-0"   |     |        |         |         |
| ai           | 1      | 1   | 1#         | 14'-0"   |     |        |         |         |
| aj           | 1      | 1   | 1#         | 14'-0"   |     |        |         |         |
| ak           | 1      | 1   | 1#         | 14'-0"   |     |        |         |         |
| al           | 1      | 1   | 1#         | 14'-0"   |     |        |         |         |
| am           | 1      | 1   | 1#         | 14'-0"   |     |        |         |         |
| an           | 1      | 1   | 1#         | 14'-0"   |     |        |         |         |
| ao           | 1      | 1   | 1#         | 14'-0"   |     |        |         |         |
| ap           | 1      | 1   | 1#         | 14'-0"   |     |        |         |         |
| aq           | 1      | 1   | 1#         | 14'-0"   |     |        |         |         |
| ar           | 1      | 1   | 1#         | 14'-0"   |     |        |         |         |
| as           | 1      | 1   | 1#         | 14'-0"   |     |        |         |         |
| at           | 1      | 1   | 1#         | 14'-0"   |     |        |         |         |
| au           | 1      | 1   | 1#         | 14'-0"   |     |        |         |         |
| av           | 1      | 1   | 1#         | 14'-0"   |     |        |         |         |
| aw           | 1      | 1   | 1#         | 14'-0"   |     |        |         |         |
| ax           | 1      | 1   | 1#         | 14'-0"   |     |        |         |         |
| ay           | 1      | 1   | 1#         | 14'-0"   |     |        |         |         |
| az           | 1      | 1   | 1#         | 14'-0"   |     |        |         |         |
| ba           | 1      | 1   | 1#         | 14'-0"   |     |        |         |         |
| bb           | 1      | 1   | 1#         | 14'-0"   |     |        |         |         |
| bc           | 1      | 1   | 1#         | 14'-0"   |     |        |         |         |
| bd           | 1      | 1   | 1#         | 14'-0"   |     |        |         |         |
| be           | 1      | 1   | 1#         | 14'-0"   |     |        |         |         |
| bf           | 1      | 1   | 1#         | 14'-0"   |     |        |         |         |
| bg           | 1      | 1   | 1#         | 14'-0"   |     |        |         |         |
| bh           | 1      | 1   | 1#         | 14'-0"   |     |        |         |         |
| bi           | 1      | 1   | 1#         | 14'-0"   |     |        |         |         |
| bj           | 1      | 1   | 1#         | 14'-0"   |     |        |         |         |
| bk           | 1      | 1   | 1#         | 14'-0"   |     |        |         |         |
| bl           | 1      | 1   | 1#         | 14'-0"   |     |        |         |         |
| bm           | 1      | 1   | 1#         | 14'-0"   |     |        |         |         |
| bn           | 1      | 1   | 1#         | 14'-0"   |     |        |         |         |
| bo           | 1      | 1   | 1#         | 14'-0"   |     |        |         |         |
| bp           | 1      | 1   | 1#         | 14'-0"   |     |        |         |         |
| bq           | 1      | 1   | 1#         | 14'-0"   |     |        |         |         |
| br           | 1      | 1   | 1#         | 14'-0"   |     |        |         |         |
| bs           | 1      | 1   | 1#         | 14'-0"   |     |        |         |         |
| bt           | 1      | 1   | 1#         | 14'-0"   |     |        |         |         |
| bu           | 1      | 1   | 1#         | 14'-0"   |     |        |         |         |
| bv           | 1      | 1   | 1#         | 14'-0"   |     |        |         |         |
| bv           | 1      | 1   | 1#         | 14'-0"   |     |        |         |         |
| bw           | 1      | 1   | 1#         | 14'-0"   |     |        |         |         |
| bx           | 1      | 1   | 1#         | 14'-0"   |     |        |         |         |
| by           | 1      | 1   | 1#         | 14'-0"   |     |        |         |         |
| bz           | 1      | 1   | 1#         | 14'-0"   |     |        |         |         |
| ca           | 1      | 1   | 1#         | 14'-0"   |     |        |         |         |
| cb           | 1      | 1   | 1#         | 14'-0"   |     |        |         |         |
| cc           | 1      | 1   | 1#         | 14'-0"   |     |        |         |         |
| cd           | 1      | 1   | 1#         | 14'-0"   |     |        |         |         |
| ce           | 1      | 1   | 1#         | 14'-0"   |     |        |         |         |
| cf           | 1      | 1   | 1#         | 14'-0"   |     |        |         |         |
| cg           | 1      | 1   | 1#         | 14'-0"   |     |        |         |         |
| ch           | 1      | 1   | 1#         | 14'-0"   |     |        |         |         |
| ci           | 1      | 1   | 1#         | 14'-0"   |     |        |         |         |
| cj           | 1      | 1   | 1#         | 14'-0"   |     |        |         |         |
| ck           | 1      | 1   | 1#         | 14'-0"   |     |        |         |         |
| cl           | 1      | 1   | 1#         | 14'-0"   |     |        |         |         |
| cm           | 1      | 1   | 1#         | 14'-0"   |     |        |         |         |
| cn           | 1      | 1   | 1#         | 14'-0"   |     |        |         |         |
| co           | 1      | 1   | 1#         | 14'-0"   |     |        |         |         |
| cp           | 1      | 1   | 1#         | 14'-0"   |     |        |         |         |
| cq           | 1      | 1   | 1#         | 14'-0"   |     |        |         |         |
| cr           | 1      | 1   | 1#         | 14'-0"   |     |        |         |         |
| cs           | 1      | 1   | 1#         | 14'-0"   |     |        |         |         |
| ct           | 1      | 1   | 1#         | 14'-0"   |     |        |         |         |
| cu           | 1      | 1   | 1#         | 14'-0"   |     |        |         |         |
| cv           | 1      | 1   | 1#         | 14'-0"   |     |        |         |         |
| cv           | 1      | 1   | 1#         | 14'-0"   |     |        |         |         |
| cw           | 1      | 1   | 1#         | 14'-0"   |     |        |         |         |
| cx           | 1      | 1   | 1#         | 14'-0"   |     |        |         |         |
| cy           | 1      | 1   | 1#         | 14'-0"   |     |        |         |         |
| cz           | 1      | 1   | 1#         | 14'-0"   |     |        |         |         |
| da           | 1      | 1   | 1#         | 14'-0"   |     |        |         |         |
| db           | 1      | 1   | 1#         | 14'-0"   |     |        |         |         |
| dc           | 1      | 1   | 1#         | 14'-0"   |     |        |         |         |
| dd           | 1      | 1   | 1#         | 14'-0"   |     |        |         |         |
| de           | 1      | 1   | 1#         | 14'-0"   |     |        |         |         |
| df           | 1      | 1   | 1#         | 14'-0"   |     |        |         |         |
| dg           | 1      | 1   | 1#         | 14'-0"   |     |        |         |         |
| dh           | 1      | 1   | 1#         | 14'-0"   |     |        |         |         |
| di           | 1      | 1   | 1#         | 14'-0"   |     |        |         |         |
| dj           | 1      | 1   | 1#         | 14'-0"   |     |        |         |         |
| dk           | 1      | 1   | 1#         | 14'-0"   |     |        |         |         |
| dl           | 1      | 1   | 1#         | 14'-0"   |     |        |         |         |
| dm           | 1      | 1   | 1#         | 14'-0"   |     |        |         |         |
| dn           | 1      | 1   | 1#         | 14'-0"   |     |        |         |         |
| do           | 1      | 1   | 1#         | 14'-0"   |     |        |         |         |
| dp           | 1      | 1   | 1#         | 14'-0"   |     |        |         |         |
| dq           | 1      | 1   | 1#         | 14'-0"   |     |        |         |         |
| dr           | 1      | 1   | 1#         | 14'-0"   |     |        |         |         |
| ds           | 1      | 1   | 1#         | 14'-0"   |     |        |         |         |
| dt           | 1      | 1   | 1#         | 14'-0"   |     |        |         |         |
| du           | 1      | 1   | 1#         | 14'-0"   |     |        |         |         |
| dv           | 1      | 1   | 1#         | 14'-0"   |     |        |         |         |
| dv           | 1      | 1   | 1#         | 14'-0"   |     |        |         |         |
| dw           | 1      | 1   | 1#         | 14'-0"   |     |        |         |         |
| dx           | 1      | 1   | 1#         | 14'-0"   |     |        |         |         |
| dy           | 1      | 1   | 1#         | 14'-0"   |     |        |         |         |
| dz           | 1      | 1   | 1#         | 14'-0"   |     |        |         |         |
| ea           | 1      | 1   | 1#         | 14'-0"   |     |        |         |         |
| eb           | 1      | 1   | 1#         | 14'-0"   |     |        |         |         |
| ec           | 1      | 1   | 1#         | 14'-0"   |     |        |         |         |
| ed           | 1      | 1   | 1#         | 14'-0"   |     |        |         |         |
| ee           | 1      | 1   | 1#         | 14'-0"   |     |        |         |         |
| ef           | 1      | 1   | 1#         | 14'-0"   |     |        |         |         |
| eg           | 1      | 1   | 1#         | 14'-0"   |     |        |         |         |
| eh           | 1      | 1   | 1#         | 14'-0"   |     |        |         |         |
| ei           | 1      | 1   | 1#         | 14'-0"   |     |        |         |         |
| ej           | 1      | 1   | 1#         | 14'-0"   |     |        |         |         |
| ek           | 1      | 1   | 1#         | 14'-0"   |     |        |         |         |
| el           | 1      | 1   | 1#         | 14'-0"   |     |        |         |         |
| em           | 1      | 1   | 1#         | 14'-0"   |     |        |         |         |
| en           | 1      | 1   | 1#         | 14'-0"   |     |        |         |         |
| eo           | 1      | 1   | 1#         | 14'-0"   |     |        |         |         |
| ep           | 1      | 1   | 1#         | 14'-0"   |     |        |         |         |
| eq           | 1      | 1   | 1#         | 14'-0"   |     |        |         |         |
| er           | 1      | 1   | 1#         | 14'-0"   |     |        |         |         |
| es           | 1      | 1   | 1#         | 14'-0"   |     |        |         |         |
| et           | 1      | 1   | 1#         | 14'-0"   |     |        |         |         |
| eu           | 1      | 1   | 1#         | 14'-0"   |     |        |         |         |
| ev           | 1      | 1   | 1#         | 14'-0"   |     |        |         |         |
| ev           | 1      | 1   | 1#         | 14'-0"   |     |        |         |         |
| ew           | 1      | 1   | 1#         | 14'-0"   |     |        |         |         |
| ex           | 1      | 1   | 1#         | 14'-0"   |     |        |         |         |
| ey           | 1      | 1   | 1#         | 14'-0"   |     |        |         |         |
| ez           | 1      | 1   | 1#         | 14'-0"   |     |        |         |         |
| fa           | 1      | 1   | 1#         | 14'-0"   |     |        |         |         |
| fb           | 1      | 1   | 1#         | 14'-0"   |     |        |         |         |
| fc           | 1      | 1   | 1#         | 14'-0"   |     |        |         |         |
| fd           | 1      | 1   | 1#         | 14'-0"   |     |        |         |         |
| fe           | 1      | 1   | 1#         | 14'-0"   |     |        |         |         |
| ff           | 1      | 1   | 1#         | 14'-0"   |     |        |         |         |
| fg           | 1      | 1   | 1#         | 14'-0"   |     |        |         |         |
| fh           | 1      | 1   | 1#         | 14'-0"   |     |        |         |         |
| fi           | 1      | 1   | 1#         | 14'-0"   |     |        |         |         |
| fj           | 1      | 1   | 1#         | 14'-0"   |     |        |         |         |
| fk           | 1      | 1   | 1#         | 14'-0"   |     |        |         |         |
| fl           | 1      | 1   | 1#         | 14'-0"   |     |        |         |         |
| fm           | 1      | 1   | 1#         | 14'-0"   |     |        |         |         |
| fn           | 1      | 1   | 1#         | 14'-0"   |     |        |         |         |
| fo           | 1      | 1   | 1#         | 14'-0"   |     |        |         |         |
| fp           | 1      | 1   | 1#         | 14'-0"   |     |        |         |         |
| fq           | 1      | 1   | 1#         | 14'-0"   |     |        |         |         |
| fr           | 1      | 1   | 1#         | 14'-0"   |     |        |         |         |
| fs           | 1      | 1   | 1#         | 14'-0"   |     |        |         |         |
| ft           | 1      | 1   | 1#         | 14'-0"   |     |        |         |         |
| fu           | 1      | 1   | 1#         | 14'-0"   |     |        |         |         |
| fv           | 1      | 1   | 1#         | 14'-0"   |     |        |         |         |
| fv           | 1      | 1   | 1#         | 14'-0"   |     |        |         |         |
| fw           | 1      | 1   | 1#         | 14'-0"   |     |        |         |         |
| fx           | 1      | 1</ |            |          |     |        |         |         |

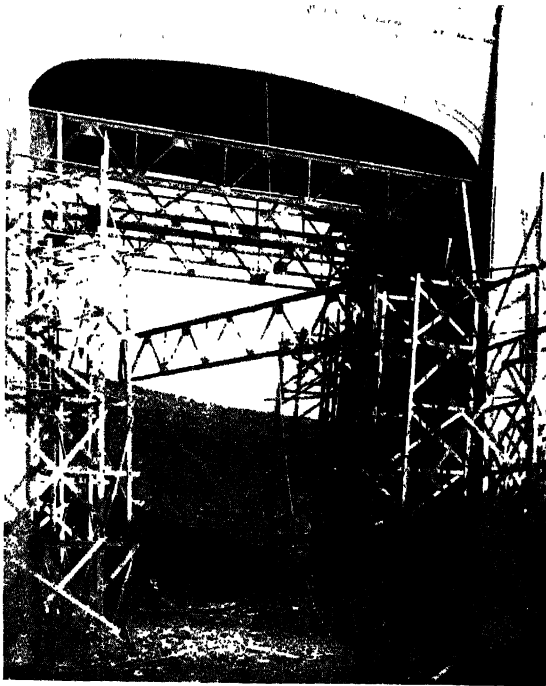

Fig. 287.—Dismantling Steel Girders.

possibility to keep down constructional costs should be noted. The clear span of the bridge is 123 ft., providing a 24-ft. width between parapets, and a road level at about 32 ft. above the rocky bed of the river. The bridge has replaced an existing bow-string girder bridge which can be seen in some of the illustrations. A special design was adopted so that all the shuttering could be suspended from the reinforcement, part of which consisted of steel trusses cantilevered out from each abutment. The detail of the steel trusses is shown in *Fig. 288*, and *Fig. 290* shows the trusses in position before the assembly of additional mild steel bar reinforcement. *Fig. 289* gives details of the mild steel bar reinforcement which, combined with the steel in the trusses, made up the total reinforcement required in the cantilevers. *Fig. 291* shows the combination of mild steel bars and structural steel trusses prior to the assembly of the shuttering which was hung from the trusses. The arrangement of the shuttering was specified by the engineer, and is indicated in *Figs. 294 to 296*. A special programme of concreting had to be arranged in order to provide sufficient strength in the composite cantilevers at each stage of the construction, so that finally, when the parapet cantilever beams were completed, they were able to carry the deck beams and deck slab.

In addition to the cantilevers, which had a span of approximately 38 ft., a

freely-supported central span was embodied in the design, and the construction of this portion of the work exemplified Method (4). In this case, three 24-in. by 7½-in. rolled steel joists were built resting on the completed cantilever arms, and the parapet girder shuttering from the free span was hung from this superstructure.

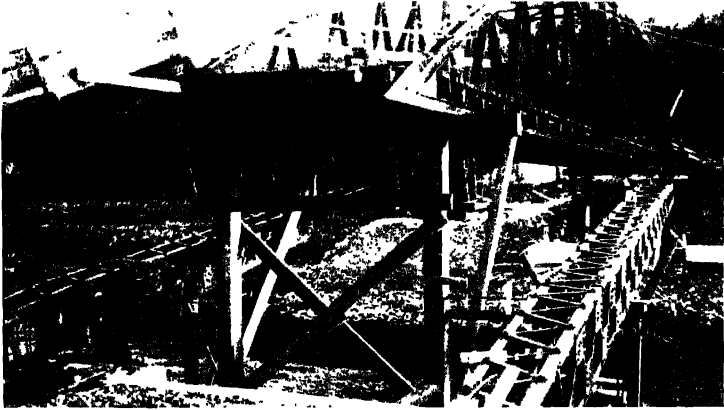

Fig. 290. Steel Cantilevers on North Side in Position.



Fig. 291.—Rear Arm of Cantilever : Splice Bars for Hinge on Right.

Some of the details of the construction of the shuttering are seen in *Fig. 292*, which shows the free span completed prior to removal of the temporary supporting rolled steel joists and steel hangers, etc. *Fig. 293* also shows certain details of the construction, besides illustrating the appearance of the completed parapet cantilever girders.

The contractor jacked up the old bow-string girder bridge and used this as a foot bridge and a satisfactory means of transporting materials and light plant across the river during the construction of the new bridge. The new bridge has a somewhat unusual appearance, which, however, cannot be considered unpleasing, and the total cost of the structure was less than £10,000. A clear indication is provided of the economy of the design and constructional methods.

Further examples of shuttering and centering for bridges of small and medium span are given in the following.

In *Fig. 297*, which is an application of Method No. 1, timber is used for the staging instead of tubular-steel scaffolding shown in *Fig. 282*. The former illustration also shows the centering for the arch soffit and the construction of the shuttering for the columns supporting the deck.



**Fig. 292.**—Free Span completed Prior to Removal of Supports.



**Fig. 293.**—Showing Parapet Girders.

With arches of large span and considerable height it is not always convenient or economical to support the staging on a large number of closely-spaced foundations. In such cases one or more intermediate foundations are provided between the abutments, and from the former the staging fans out to support the full length of the soffit. When intermediate foundations for the staging are impracticable, a temporary timber arch is erected with the same profile as the soffit of the arch in the finished bridge. Where the construction of this falsework arch in its completed position presents difficulties, it may be made in two semi-arch sections, in an almost vertical position, with hinges at the base of each section. When both of the latter are complete, they are lowered (rotating about the base hinges) until meeting at the crown, where they are secured. Illustrations of this system on the reconstruction of Longeray viaduct in France are given in *Figs. 298* and *299*. *Fig. 298* shows the falsework sections completed and erected in the

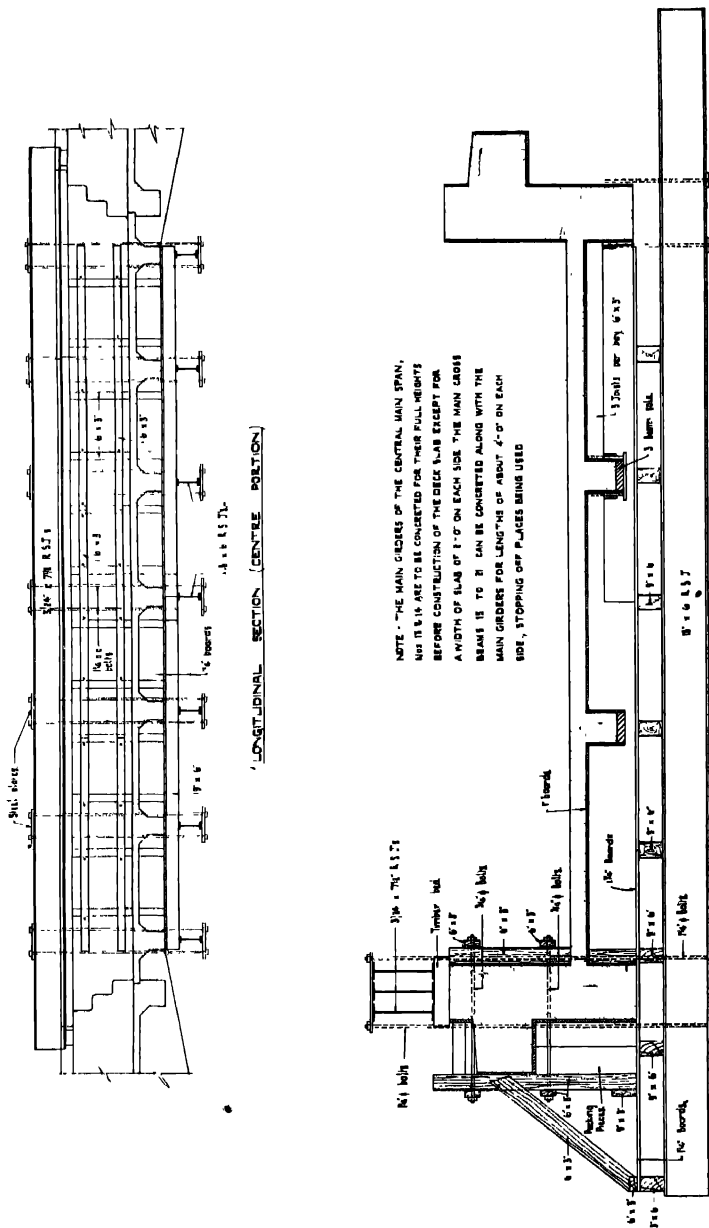

Fig. 294.—Centering to Middle Span



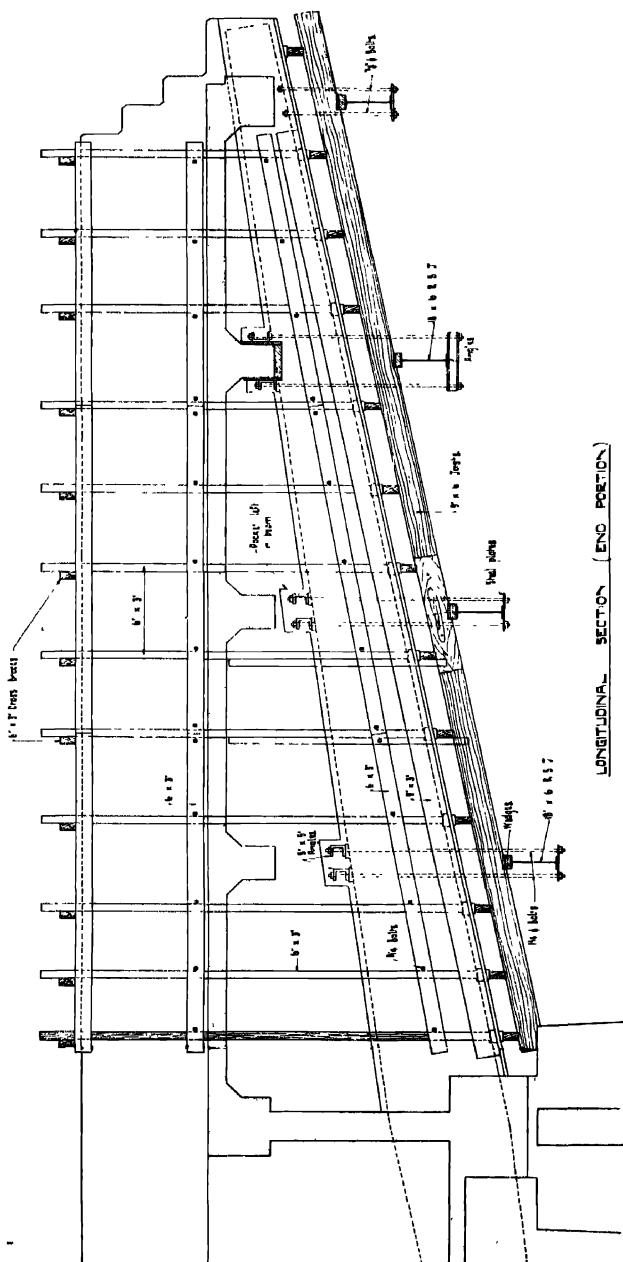

Fig. 295.—Centering for End Span (see also Fig. 296).

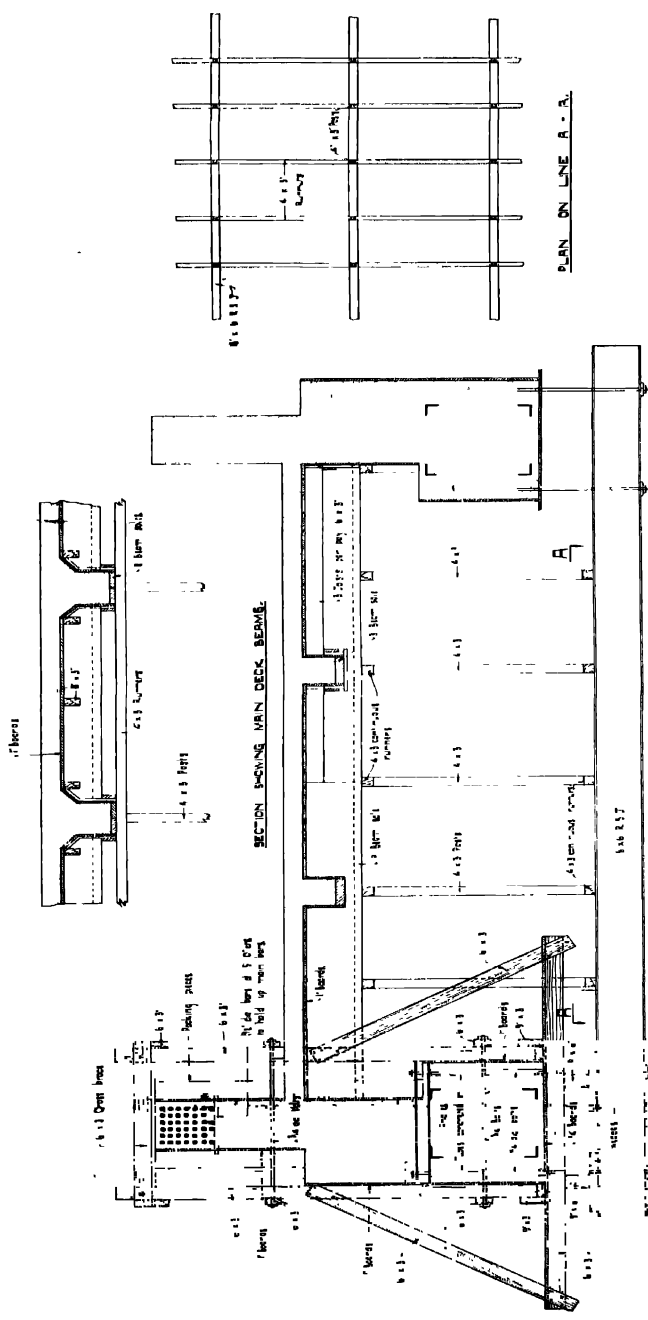
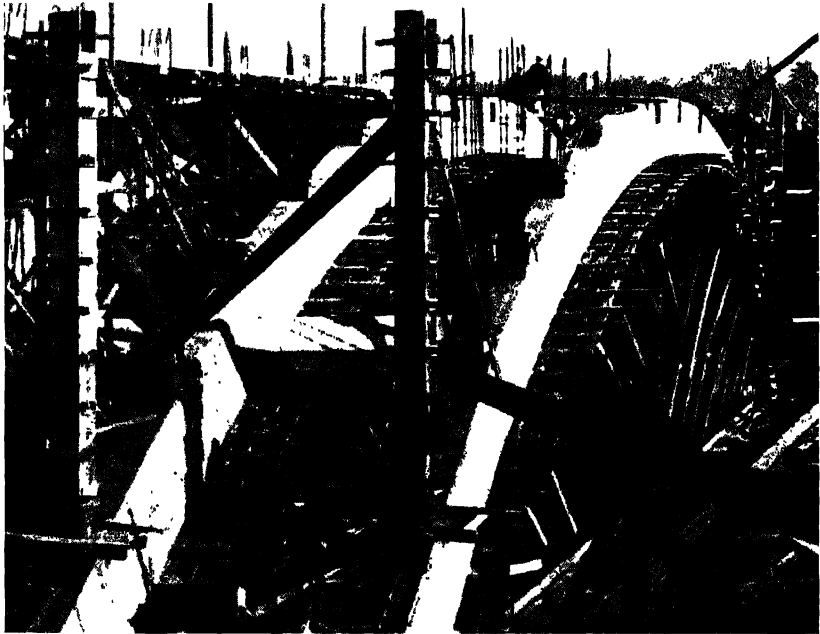

Fig. 296.—Centering for End Span (see also Fig. 295).

vertical position ready for lowering. Each section weighed 120 tons and was provided with six 6-in. diameter steel pins as hinges at the springing. *Fig. 299* shows the two sections lowered and connected, and the concreting of the arch ribs proceeding. This method was used only for the central span where the nature of the river precluded the more conventional method adopted for the adjacent spans. On this contract concrete was distributed by an overhead ropeway, parts of which are visible in the illustrations.

Hinged arch profiles were also used for the reconstruction of Carmarthen bridge, although this example can be classified as Method No. 2 since the lattice-

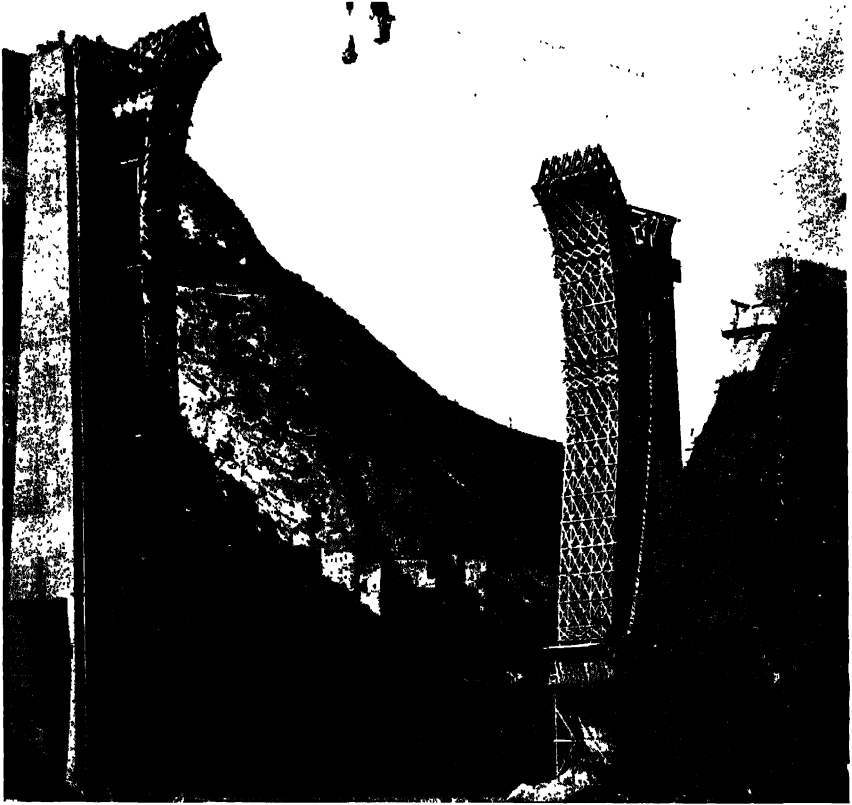

**Fig. 297.**—Timber Staging for Open-Spandrel Bridge.

steel trusses with curved top chords were supported on projections from the piers and abutments as shown in *Fig. 300*, which also gives details of the construction and method of erection of the trusses for the 70-ft. span arches. The trusses were spaced at intervals of 6 ft., and 9-in. by 3-in. timbers with a 9-in. space between each were laid on the flat to span between the steel trusses. Ply-wood sheeting was nailed to these timbers to form the soffits of the arch slabs.

An example of centering (Method No. 2) for a high viaduct is illustrated in *Fig. 301*, where typical timber centres for semi-circular arches are supported on the caps of the tall concrete piers.

A common method of supporting the deck shuttering for a bridge over a railway is shown in *Fig. 302*. Owing to the restricted space between the loading



**Fig. 298.—Arch Centering Ready for Lowering.**



**Fig. 299.—Arch Centering lowered into Position.**



gauge and the underside of the concrete deck, the depth of the falsework must be reduced to a minimum, and this is done by spanning a combination of steel and timber joists between strong timber trestles built up from the concrete bases of the piers.

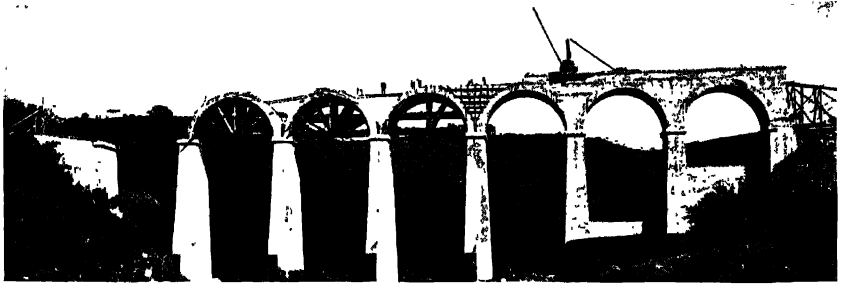

Fig. 301. Centering for Arches of a Viaduct.

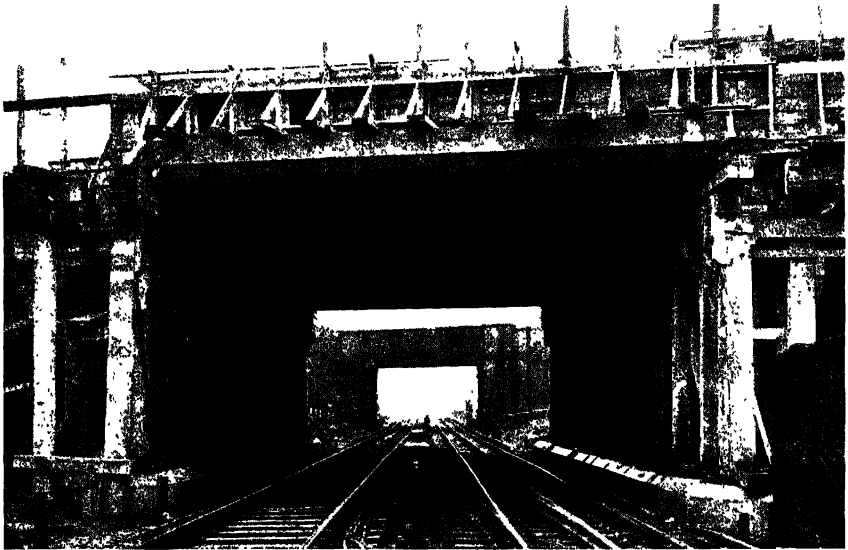

Fig. 302.—Shuttering for Bridge with Restricted Headroom.

It will be realised from these few examples that the design of staging and shuttering is really creative work, in which contractors and engineers in the past have been able to produce excellent results under the stimulus of price limitation. The engineer might specify completely the construction of staging and tem-

porary bridges, etc., in every case, but a serious drawback might result from the general adoption of such a procedure. A contractor, left free to choose his own design, subject to reasonable supervision by the engineer, is able to make use of suitable spare materials which he may have in his yard, or which may be readily available, despite the fact that such a course might not provide the most economical solution. The engineer might, of course, prepare a design for the staging and shuttering and then allow the successful contractor certain freedom in carrying out the work, but this would be unfair in many instances, as the contractor might have in mind certain possibilities which would not comply with the engineer's designs and, as a result, might ultimately be compelled to adopt the engineer's specification with considerable loss to himself.

There is so little standardisation in reinforced concrete bridges that there is usually little scope for the use of steel shuttering in the main part of the structure, but such shuttering may be suitable for such ancillary works as retaining walls and for pile moulds.

## CHAPTER XV

### REINFORCEMENT

ORDERING—STORING ON SITE—BENDING—WELDING—FIXING

THE success of a reinforced concrete structure depends, for both strength and permanency, on giving careful attention at the site to the instructions on the detail drawings. Every part of the construction work is important, and, whilst concreting is perhaps the most important factor, the correct bending and fixing of the reinforcement in accordance with the details is almost equally so.



Fig. 303.

Should any reinforcement be placed nearer to the shuttering than is indicated by the details the reduced thickness of concrete protection may permit attack by atmospheric influences, with the result that rusting and ultimate deterioration of the structure will develop. This remark applies not only to the main bars, but to the stirrups or binders and even to the tying wire, all of which must be given an adequate cover of concrete if they are to be permanent.

One sometimes hears a remark that "Reinforced concrete is all steel and



no concrete" or that "There is so much reinforcement that one does not know how to get the concrete into place." An oversight in detailing might conceivably produce an arrangement difficult to construct, but in cases where such statements are made, investigation will usually prove it to be due either to ignorance or to prejudice, and the bending and fixing of the reinforcement and the concreting around it have ultimately been successfully carried out without calling for more than the usual care to which reinforced concrete work is entitled. With a view to discounting statements of a similar nature, two illustrations of somewhat complicated reinforcement are given. *Fig. 303* shows the reinforcement for an arch rib, with longitudinal bars bound together by five interlocking helices. This arrangement occurs in both the top and the bottom of the arch ribs and the two systems are connected by the usual type of stirrups. The outside of the reinforcement is within 3 in. of the shuttering, and to add to the difficulty of fixing reinforcement the arch was 70 ft. above ground at the crown and its span was 184 ft.

*Fig. 304* shows the reinforcement in the top of a cantilever forming part of a



**Fig. 304.**

bridge having a span of 124 ft. This reinforcement consists of 28 bars in seven layers, with clear spaces between the bars, both vertically and horizontally, of about  $1\frac{1}{2}$  in. Stirrups were introduced around the bars, although only a few of them are shown on the photograph. This, again, is an example of exceptionally heavy reinforcement, the necessity for which will be appreciated when it is realised that four similar cantilevers carry the whole load of both structure and traffic for a modern highway bridge of 124 ft. clear span. It is seldom that such complicated cases of reinforcement as these occur, but in both cases the reinforcement was assembled by general steel fixers without great difficulty and without excessive cost. In addition, the concrete in the finished work was free from defects.

Whilst these notes are likely to present little or nothing new to the experienced reinforced concrete contractor, they may be of assistance to those who have seldom undertaken this class of work. In the event of a general contractor undertaking reinforced concrete work of any magnitude, a foreman experienced in this class of work, and an experienced steel bender and fixer, who will handle

the whole of the reinforcement, should be employed. In this way better work results, and the work will be carried out more economically than if it is attempted without experienced assistance.

### Ordering.

The reinforcement for each work is usually ordered separately from a rolling mill, or from a merchant. Where the quantity required is less than about four tons it is usual to purchase from a merchant who stocks bars of various diameters and of lengths up to 30 ft. For greater quantities the order is sent to a mill to be executed as the bars are rolled.

When the reinforcement required does not exceed, say, ten tons, it is usual to obtain the whole of the material in one consignment, but for larger works the amount required is usually divided into two or more consignments. This is a wise procedure, for if one obtains delivery at the site of a large quantity there may be considerable difficulty later in sorting different sizes and lengths for different parts of the work. Where several deliveries are to be made all the material for each section should be included with the relative consignment; for example, when ordering foundation steel the splice bars for the columns or walls must be included, as these must be concreted in at the same time as the foundation steel. As a general rule the designer prepares the bending schedules with this point in mind, and if this is done it is safe to order the reinforcement in accordance with the bending schedules and steel order sheets which are, or should be, provided by the designing engineer. Usually this entails a separate steel sheet for each drawing or, in some cases, group of drawings.

Generally, reinforcing steel is ordered to be delivered to the site straight and cut to the lengths required. Sometimes, where there is special urgency, stock lengths of 20 ft. to 30 ft. may be ordered and cut to the required lengths at the site. This, however, creates difficulties for the designer and waste of steel for the contractor, and is not to be recommended in normal cases. Where it is done the longest length available should be ordered so as to reduce the amount of waste left after cutting.

Steel from  $\frac{5}{8}$  in. diameter upward is generally delivered loose, but the smaller diameters are made up in bundles of the same diameter and similar lengths. Where the site is within, say, 20 miles of the rolling mill, it is generally advantageous to have the material delivered by road, but in the majority of bridge works it is sent by rail to the nearest station and taken by lorries to its destination. For bars of short and medium lengths ordinary lorries are used, but for very long bars special trucks are necessary.

On works of any size, particularly in remote districts, it is an advantage to include in the order a little more steel than is shown to be required by the detailed drawings and steel lists. This additional steel is used as a site stock and can be drawn on for any of the odd purposes for which reinforcing bars are used on works, to replace missing bars, or to provide without delay reinforcement for any minor alterations or additions which may be ordered during construction.

Since bending reinforcement takes some time it is advisable to order sufficiently far ahead to permit of the steel being delivered and bent before it is required in the work. It is also important to arrange for delivery to the site in sufficient time to ensure that the mill scale will have weathered off before the

reinforcement is concreted in. In wet weather it may take about a month for the scale to weather off, but in long periods of drought many weeks may be required and arrangements should be made for the contractor to water the steel two or three times a day to accelerate the rusting off of the mill scale. In special cases acid has been used for this purpose, but this is hardly to be recommended, from the point of view of either safety or expense, except in special cases. When it is used a neutralizer should be applied after the scale has disappeared and before the bars are used.

Occasionally reinforcement is delivered to the site bent ready for fixing. There is some advantage in this arrangement when the contractor has little experience or equipment for dealing with reinforced concrete work, but only in such cases. It will usually be found that handling bent bars during transport is more difficult than handling straight lengths; in addition, bent bars are much

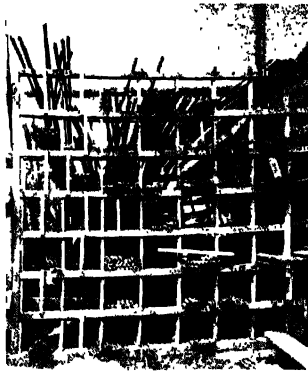

Fig. 305.

more liable than straight bars to be distorted in handling. Even though the steel may be bent ready for fixing, it is often found that by the time the bars arrive at the site they require to be trued-up on the bending bench before being placed in the work. These remarks do not apply so strongly if the material can be loaded directly into wagons or lorries alongside the works' bending machines and unloaded from the same vehicles alongside the work into which they are to be placed.

#### **Storing on Site.**

On delivery it is advisable to sort and store the bars in a methodical manner until they are required for bending and fixing. Unless this is done chaos will result, for a consignment may contain several hundred bars each of which is intended for a special position in the work. Whilst they are being unloaded the bars can easily be separated into groups of different diameters and graded by length, but if they are simply unloaded into one heap the selection of the correct bars at a later date is very troublesome and costly.

It is therefore usual to store the steel in groups of different diameters graded by length. The method of storing depends on the space available for handling

the bars. If this is considerable the bars are usually laid horizontally on sleepers resting directly on the ground, the different diameters and lengths being separated by stakes driven into the ground and marked with the description of the steel which they define. This is probably the most convenient method and does not involve hoisting any rods, and the selection of sizes and lengths for bending is an easy matter.

Where less space is available suitable racks with several tiers (*Fig. 305*) may be arranged in which the bars are laid and graded by diameter and length. It is necessary to mark at the end of the racks the diameters and lengths contained, since the lengths cannot easily be checked as the bars lie in the racks. It is advisable to keep bars of large diameter and the longer lengths in the lower racks in order to reduce the weights to be handled to and from the higher levels.

Bars should be checked against the steel sheets immediately after delivery. This is facilitated if the ends of all bars in each stack are tapped flush. The ends can then be chalk marked as they are counted and there is no risk of some of the shorter rods being missed.

Where only a very small area of ground is available, bars may be stacked on end. This method is not suitable for bars of greater lengths than 18 ft. to 20 ft., and in consequence is not generally adopted except in stock yards. In all cases the rods should be kept clear of the ground unless this happens to be a hard surface into which the rods will not sink; otherwise the bars will sink into the ground and considerable labour may be necessary to dislodge and clean them.

Subject to the bars having been delivered in comparatively small consignments, it is better for them to be stored in the open so that the mill scale may weather off. If they are stored under cover the mill scale is likely to remain for several months. In cases, however, where the bars are not to be used in the work for a period of, say, six months or more, they should be stored under cover, for if they lie in the open for longer than six months not only will the mill scale disappear and ordinary permissible rusting commence, but it is probable that rust scales will form. If this occurs every rod must be thoroughly brushed with a stiff wire brush to clear it of rust scales before use in the work.

### Bending.

As a general principle all reinforcing steel should be bent to the required shapes in a cold condition. Only in the case of exceptionally large diameter bars and exceptionally sharp bends can heating be considered, and this should only be carried out with the permission of the engineer. Where permitted, the steel should be heated to a cherry-red heat and allowed to cool slowly.

Generally the tools used for bending are supplied by the contractor. Usually they are very simple and for the small sizes can be made by any handy man. For bars up to  $\frac{3}{8}$  in. or  $\frac{1}{2}$  in. diameter a light claw twister or "dog" of one of the types shown in *Figs. 306, 307* and *308* may be used; the length of the lever is usually from 1 ft. 6 in. to 2 ft. 6 in. For diameters of  $\frac{3}{4}$  in. or  $\frac{7}{8}$  in., a lever of normal weight, for  $\frac{7}{8}$  in. to  $1\frac{1}{8}$  in. a heavier lever, and for  $1\frac{1}{8}$  in. upward to  $1\frac{1}{2}$  in. diameter an extra heavy lever of the type shown in *Fig. 309* is suitable. Except for the lightest claw bars, the heads should be made of cast steel set in very heavy tubing, as ordinary forgings will not stand up to the work.

The bending tool for heavy material, termed a "dog," consists of a rectangular block of hard cast steel set in a tube-steel handle, which may vary from 3 ft. to 6 ft. in length. In the block is a semi-cylindrical hollow, whose diameter

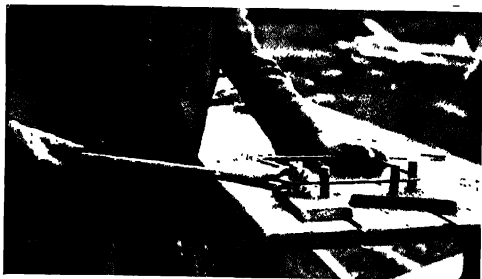

Fig. 306.

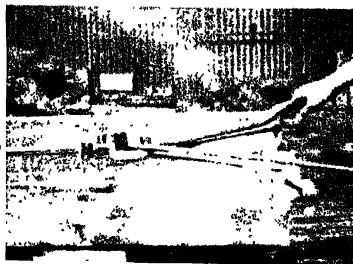

Fig. 307.

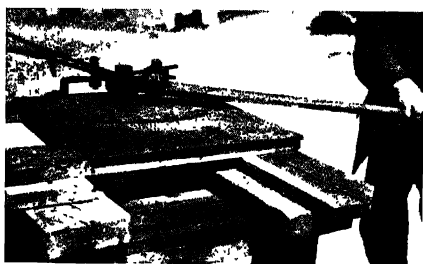

Fig. 308.



Fig. 309.



Fig. 310.

is slightly greater than that of the bar to be bent. This is placed over the bar at the tangent point of the curve of the bend, the face of the block lying flush with the plate on the table. It is essential that the plate be large enough to take

the block of the dog for its full swing, as difficulties would arise if the block were to leave the plate when bending. A railing may be erected around the circle described by the outer end of the lever and fitted with a rod stapled on to take the weight of the lever and act as a runway for it.

For bending light steel up to about  $\frac{1}{2}$  in. diameter, either the claw or the twister type of tool may be used. The former gives better alignment, as the twister is apt to twist the steel unless carefully handled. The twister is quicker in use, but the choice of tool is largely a matter of individual preference.

The twister (*Fig. 307*) is of horseshoe shape, with one shank bent into a cranked handle which allows the tool to be kept flush with the bending table when bending. The other shank of the horseshoe is formed into a small upstand, against which the bar is forced when bending. The horseshoe portion fits loosely on the bending pin so that it can be swung round it easily. The bar is fitted between the resistance pin, bending pin and twister, its length being gauged by the distance pins. The handle of the bender in the initial stage stands at right angles to the bar, away from the person bending, who pulls it towards himself when bending.

The principle of the claw bender (*Fig. 306*) is similar, the bar being passed through the fork of the claw, the tails of which are curved to fit the bending pin. This bender is different from the twister insofar as it must be readjusted for each bend, whereas the twister is never removed from the pin.

In addition to these somewhat primitive, though effective, appliances, several types of geared machines are made, one of which is illustrated in *Fig. 310*. Whilst these enable one man to bend a larger diameter bar than can be done with the direct lever method, it takes him proportionately longer. Such machines form part of the permanent plant of all specialist reinforced concrete contractors. The machines are equipped with collars of various sizes to permit the hooks and bends on the bars being adjusted to suit the standard for each diameter of bar.

In addition to hand-driven geared machines, there is also on the market a number of power-driven machines which are very suitable for large work but would not normally be purchased specially except for works in which the weight of steel amounted to two hundred tons or more.

In addition to the bending tools or machines, benches are required. These should be long enough to support the longest bar to be handled and wide enough to extend under the largest crank in any bar with a little to spare. Sometimes the benches may be shorter than the longest bar, in which case trestles are necessary to support the length of bar projecting beyond the bench. Benches are usually made on the site, generally of 9-in. by 3-in. timber, and should be thoroughly, even if roughly, made, well stayed and braced, and very rigidly fixed to the ground. For large diameter bars the bench may have to withstand the full force exerted by several men at the end of a long lever.

Plates and pins will also be required similar to those shown in the illustrations of the bending tools. For heavy bars the pins, etc., are arranged as follows. Two iron plates, each about 2 ft. square and  $\frac{1}{2}$  in. thick, are bolted firmly, one on top of and one underneath the table. Holes are arranged in the plates to take iron pins tightly when driven through the bench. The success of bending lies in the tightness of the pins which resist the force exerted in bending. *Fig. 311* shows a general arrangement and spacing of such plates and pins. For

bending light material a somewhat similar arrangement is employed, except that instead of a resistance pin a block of wood is sometimes used. Also light iron "distance pins" are driven into the bench at certain distances from the bending pin in order to save measuring each length when a large number of one size is required, as, for instance, in bending stirrups.

Slab bars may be bent two or three at a time, although there is some doubt whether this is real economy, because the handling of two or three bars is sometimes awkward. The procedure in the bending of slab bars and beam bars is similar. In both cases one of the end hooks is first made, and then the positions of the remaining bends are marked in chalk along the bar and the bends produced, working from one end. Any surplus length of bar is left at the free end

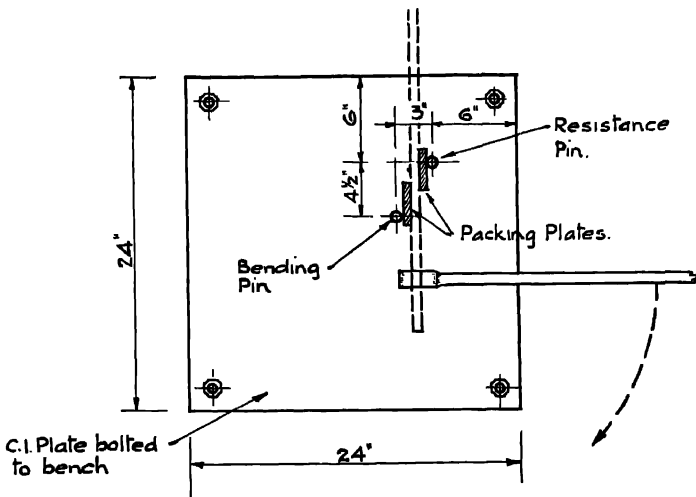

Fig. 311.

of the final hook. Due to the creep of the bar around the pins in bending, a certain amount of experience is required to ascertain the exact point at which a bar should be gripped in order to produce the bend in the right place. With a little experience, however, this can be done accurately on every occasion.

Some column bars are straight throughout their length, but in the majority of cases they are cranked at their upper end to reduce to the size required in the column above, or to fit among the beam reinforcement at the column support. These cranks are made in exactly the same way as for beam reinforcement. Sometimes the bars are built in straight, and the cranks formed after the concrete below the crank has set. For bars exceeding  $\frac{3}{8}$  in. diameter this method is not recommended, as bending of the steel after it has been embedded is liable to fracture the concrete.

Another type of large diameter bar which is often required in bridge construction is that which forms the main reinforcement of an arch rib or an arch

slab. These generally have hooks at both ends and are bent to a very large radius between. If, in the design, the diameter of these bars can be kept down to about 1 in., it will usually be found that the bars take up their correct curve when laid on the centering or require only very little adjustment to bring them to that curve. Thicker bars, however, must be bent and given a permanent set to the correct curvature. This can be done by moving the bar slowly around the bending pins, or in a bending machine similar to that used for bending beam bars, but giving the bar a slight set at every 2 ft. or so along its length.

Another method is to form a wooden template of the correct curve, and to place pins along this template and a little more than the diameter of the bar away from it. The bar is then put into place and, using it as a lever, is moved slowly through the space between the template and the pins and bent in the manner shown in *Fig. 312*. Still another method is to use a "Jim Crow" similar to that used for bending rails but of a lighter build. The bar is placed between the jaws and slowly moved along. At frequent intervals the tool is tightened to give a slight "set" to the bar. When bars are bent for an arch rib they should be set out carefully to full size and each bar checked against the setting-out when



Fig. 312.

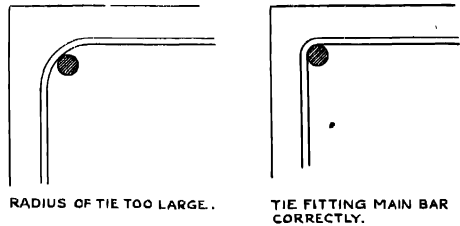

Fig. 313.

completed. This is well worth while, as in any arch there will be a fairly large number of bars to be bent to the same shape.

Stirrups for beams and binders for columns are bent with small claw bars, commencing with a half hook at one end and then working round the various sides, the pins being set in the bench to give the correct final internal size for the stirrup. A stirrup being bent is shown in *Fig. 306*. Care should be taken to ensure that the corner bends of stirrups are made to suit the bars which they will encircle. If this is not done, the main bar will be brought too close to the centre of the concrete member or there will be too little cover to the stirrups, as indicated in *Fig. 313*. The ends of the stirrups should not be too long, as when they project far into the body of the work, particularly in the case of beams, there is a risk of them fouling the adjoining main reinforcement and making assembly difficult.

Instead of independent binders, continuous rectangular binding is sometimes placed around the four bars in the corners of a column, and may have a pitch of 1½ in. to 4 in. The most satisfactory way of forming this binding is to bend them around long pins set at the same centres as the column bars, using a light claw bar. This type of reinforcement, however, is not, on the whole, so easy to handle as independent stirrups.



Another type of reinforcement which may be encountered in normal work is helical wrapping. This consists of long lengths of light bar, usually from  $\frac{3}{16}$  in. to  $\frac{1}{2}$  in. diameter, which is wound in the form of a helix around the main reinforcement. These helices are best purchased wound ready for assembling. If they are formed at the works site it is usual to wind the material around a wooden mandrel. It is necessary first to pass it over a tensioning drum, and the mandrel around which it is wound must be made of a diameter a little less than that of the finished helix in order to allow for the back-lash of the material after bending. As a general rule, if an internal diameter for the helix of 12 in. is required, the mandrel drum should have a diameter of from 10 in. to 11 in.

In bending all main bars, care should be taken to ensure that all the bends are in the same plane; this applies particularly to the two end hooks. If these are not in the same plane considerable difficulty is likely to arise when they are being assembled in the work. A hook which is not in the correct plane is liable to foul the positions of adjoining bars, and it may be necessary to take the bars back to the bench for correction.

Where a large number of bars is to be bent to the same shape, it is best to bend a sufficient number to form one of the units in the finished work, and to have these assembled before bending the remainder so that any minor adjustments of the bending dimension necessary to ensure a perfect fit and simplicity of assembly can be made.

As bars are bent they may either be stacked in groups of the same type of bar, or made up in sets for each of the beams or other members in the work. The method chosen depends very much on the type of work under consideration, and the number of members of any one type to be constructed. Where the number of members of one type is small it is probably better as the bending is completed to place together complete sets of reinforcements for each member; where the number of similar members is large, then bars of one type are better kept together.

Where the complete reinforcement for a unit is stored together it is better to collect the correct number of stirrups for each unit and wire them loosely together so that they may be easily transported without loss.

When light claw bars are being used, that is for stirrups, binders and slab bars, two men are sufficient, one for bending and the other for carrying the bars and assisting whilst the bars are in the machine. For the normal and heavy type of claw bar, two men are required for bending and two for carrying the reinforcement. For 1-in. and larger bars, an additional man should be supplied to each squad; at least four men will be required on the lever while the other assists in keeping the bar in position on the bench. Whilst the amount of steel which can be handled varies considerably with the amount of bending required on each bar and the size of the bars it may generally be taken that a squad of four will bend from three to four tons per day. Smaller diameter bars will take longer per ton to bend than those of large diameter.

Where bars are of very long lengths, say exceeding 60 ft., or where only one or two bars are required of a length of, say, 50 ft. to 60 ft., use may be made of coupling boxes. *Fig. 314* is a photograph of a coupling box, with one bar entered and the other ready for entering. Great care should be taken to ensure

that the full length of thread of the coupling box is engaged with the bars ; in fact it is wiser to ensure that the gap inside the coupling box and between the two ends of the bars does not exceed, say, 2 to 3 in. For economy, it is usual to upset the ends of bars which are to be connected by coupling boxes before screwing them. This is done by heating the bar to a bright red and then staving up the end for a length of 6 or 8 in. and forming it to a new and larger diameter. A thread is then cut on this end by a power-driven machine, such as that shown in *Fig. 315*. Generally speaking, contractors would find it an advantage to have this work done away from the site unless there is a large number of bars to handle. It is advantageous to provide four holes in the coupling boxes for tommy bars, as adjustment is sometimes required when the boxes are surrounded by reinforcement.

### Welding.

An alternative to the coupling box is a welded connection, which has advantages over the coupling box in that there is no waste of steel, no trouble

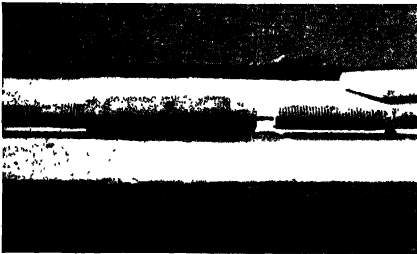

Fig. 314.

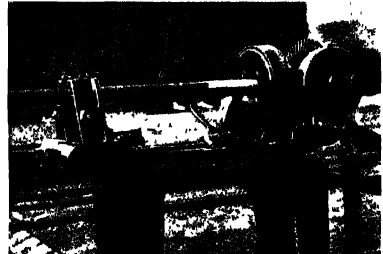

Fig. 315.

with upsetting, and a smaller diameter at the joint. The only disadvantage is the human factor which enters into the welding process. In the writers' opinion, however, this is a method which can be quite well considered, as where very long bars are required there is usually a large number of them and only one welded junction is likely to occur at any one section of the beam. Welding is of great advantage when reinforced concrete piles are being lengthened, as it forms a much neater and more effective junction than the usual over-lap or splice bar.

One method is to slip over the end of one of the bars a steel sleeve having a tensile strength 25 per cent. greater than that of the bar. The ends of the bars are butt-welded together and filed smooth. The sleeve is then slipped back to a symmetrical position over the weld and fillet-welded at both ends of the bars. Alternatively, the design and procedure adopted for welded joints should conform with the Regulations issued by the London County Council relating to the welding of reinforcement bars. Electric-arc welded butt joints are most convenient for round bars. Bars, the strength of which depends on cold-working, should not be welded unless the design stresses do not exceed those common for mild steel.

The ends of the bars to be welded, which must be rigidly held in the correct relative positions, should be shaped to enable the weld metal to be in full contact

with the ends and to ensure access for the electrode, and to enable the welder to see the work clearly. Owing to the limitation of space in bridge members work can usually proceed from the top only, and the form of end most suitable is a single **V** or **U**. Before depositing the weld metal under a single joint a small plate about  $\frac{1}{16}$  in. thick is spot-welded on to the underside of the joint to provide a seating upon which the weld is built. For large bars a single **V** joint requires a large amount of weld metal, therefore a double-**V** joint, which does not require the use of a plate, is more economical but can only be used if access to the work is available from both top and bottom.

A butt weld should be about 10 per cent. thicker than the thickness of the bars being welded, the additional thickness being dressed off to form a smooth joint.

When bars of unequal diameter are butt-welded, a single-bevel butt weld is the most suitable type of joint. A square butt weld should not be used if the thickness of the bars exceeds  $\frac{3}{16}$  in. The gaps separating the ends of the bars should not generally be less than  $\frac{1}{8}$  in. for main bars.

### Fixing.

The tools required for steel fixing are a pair of pliers with a wire-cutting device on them, or one of the patent tying tools, and a small lever to assist in levering the bars and the partly assembled units into the correct positions. A quantity of 16 to 18-gauge annealed tying wire will also be required; this is usually cut into lengths of 4 in. to 6 in., depending on the size of the bars to be connected. Instead of cutting the wire into short lengths, some steel fixers prefer to cut it as required from a small hank which can be conveniently carried in the hand. Those who advocate this method claim that with a very little practice this becomes the easier method and probably the more economical.

Reinforcement may be assembled in one of three ways.

(a) In units ready for placing into position in the work. This method is usually adopted for piles and frequently for columns, but it can rarely be satisfactorily adopted for continuous beams. The procedure is to place two or more trestles with planks between and lay across them two of the reinforcing bars to be assembled, having first slipped over them the requisite number of binders or stirrups. The remaining main bars are then threaded through and the stirrups wired in their correct positions. The planks between the trestles are then slipped out and the assembled unit is put on one side ready for fixing in the work.

(b) A method frequently adopted for beams is to assemble the reinforcement on the shuttering, immediately above the beam mould into which it is to be lowered, temporarily supporting the bars on planks placed at intervals across the beam mould. In this case also the bottom bars are laid in place with the requisite number of stirrups in position around them. The upper bars are slipped through the stirrups, and the stirrups moved along and wired in their final positions in the member. The member is then rigidly assembled, the planks are removed from below, and the complete unit is lowered into its place in the beam mould.

(c) The most general method of assembling (illustrated in *Fig. 316*) is to place the bars one by one in their final positions. This necessitates, in the case of a beam-and-slab construction, first placing in position the bottom board of

the beam mould, leaving the side shutters and the slab shuttering to be erected later. On these bottom boards the bottom bars of the members are assembled, with the stirrups slipped loosely over as before. The upper bars are then brought into place and the stirrups spaced and wired in the correct positions. After assembling the steel in the beam, the side shutters are placed in position and the slab shuttering and reinforcement placed ready for concreting. The bars may be hoisted in quantity by crane, but frequently separate bars are hoisted by a rope and pulley when a crane is not required for other purposes.

Tying the junctions or bar crossings is of importance, for it is only by doing this correctly that a really rigid assembly can be obtained which will prevent distortion or displacement during concreting. If a single wire is put around the crossing of two bars the reinforcement as a whole is not rigidly fixed. A far better method is to form the binding wire into small "hairpins," to place these around the bars, and complete the wiring as shown in *Fig. 317*. Reinforcement assembled and tied in this way provides a perfectly rigid framework. After the tying has been completed, the ends of the binding wires should be snipped off. The writers

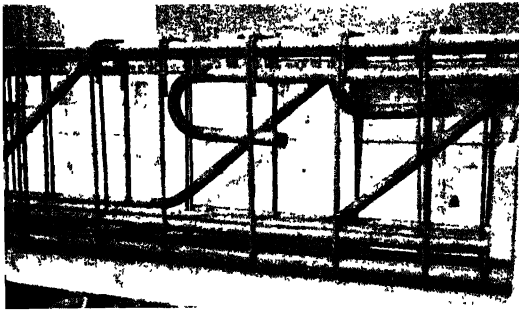

Fig. 316.

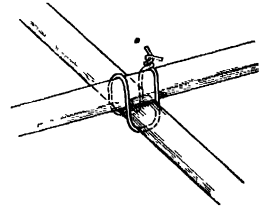

Fig. 317.

from careful inspection have found that about 90 per cent. of the rust marks on finished concrete work are due to the ends of binding wire projecting against the shuttering. The result is that the atmosphere attacks the wires after the shuttering is stripped, and progressive rusting along the wire may ultimately attack the main reinforcement. For this reason all tying wires should be snipped off  $\frac{1}{4}$  in. from the main reinforcement bars, and wherever possible the twisting should be done on the inside of the reinforcement and away from the shuttering. Before concreting, all snipped ends of binding wire, or other debris which may have collected in the mould during the placing of the reinforcement, must be washed out or removed, otherwise these become embedded in the surface of the concrete and rapidly produce rust stains.

After assembly the reinforcement must be supported in position until the concrete is placed. This can be done in one of several ways, depending on the type of reinforcement. The lifting of reinforcement into position after concreting is commenced, or even the raising of it whilst the concrete is packed beneath it, is undesirable and is liable to lead to a considerable error in the final position of the steel in the work.

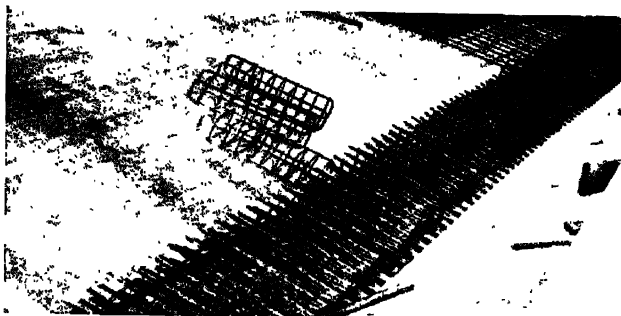

Fig. 318.

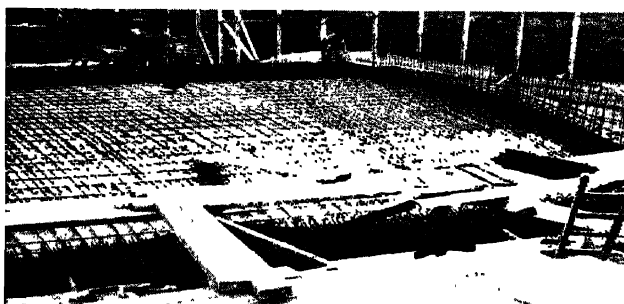

Fig. 319.



Fig. 320.

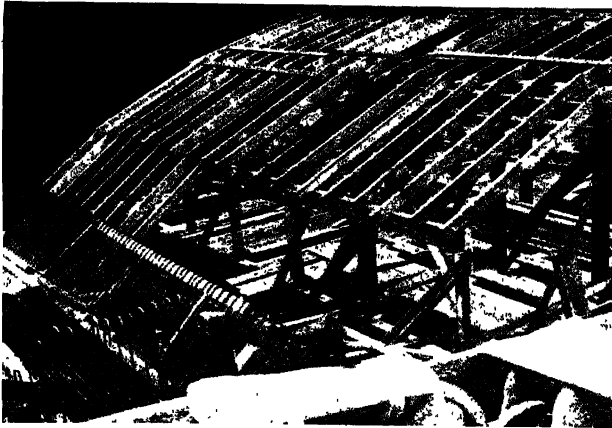

Fig. 321.

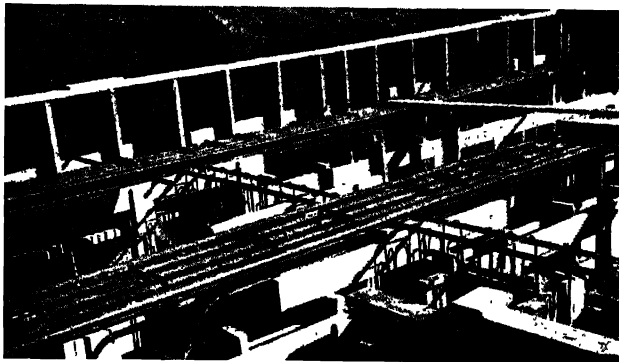

Fig. 322.

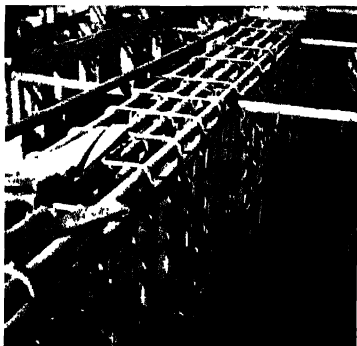

Fig. 323.



Fig. 324.

For slabs and beams, cement pats may be made having the same thickness as the requisite cover for the reinforcement. These should be about 2 in. square and should have rough edges so that they will bond with the concrete. If they are made of the same kind of mortar as that in the concrete, their positions will be almost indistinguishable in the finished work and they may be left in place. The best way to form these pats is to nail laths of the requisite thickness to form a tray on some convenient area of horizontal shuttering. This should then be filled flush with the laths with 1 : 2 cement mortar, and just before the mortar takes its final set it should be scored with the edge of a trowel run along a straight-edge to form 2-in. squares. The next morning the laths can be removed, and the mortar broken along the lines of the scoring to produce small blocks with rough edges which can be left to harden and used as required.

Another method of supporting beam reinforcement is to insert under the top bars rods or pieces of timber resting on the side shutters of the beam or on the slab shuttering. The beam can then be concreted, except in the immediate vicinity of the supports, and the supports can be removed before concreting the slab above. In the case of splice bars extending from abutments into arch barrels or ribs, special supports are required.

For wall reinforcement, splice bars can be kept in their correct position in the foundations by wiring them temporarily to planks. The vertical steel is wired to the splice bars, and after the horizontal steel is wired to it a rigid assembly results. When concreting a wall, however, it is desirable to keep a slip of timber between the shuttering and the reinforcement, the timber being of the correct thickness to preserve the cover required and moved up in order to keep it about 3 ft. above the level at which concreting is taking place.

The photographs show the assembly of reinforcement in different types of bridge work. *Fig. 318* shows the reinforcement of the hinge of a three-hinge barrel arch in position in the abutment, and, in the upper right-hand corner, the commencement of the assembly of the arch-barrel bars using the small pre-assembled units shown lying on the shuttering, some of which are already fitted between the splice bars. An interesting feature of this hinge construction is that the middle 12-in. length of the hinge bar was sprayed with molten zinc. *Figs. 319* and *320* show the same bridge with the crown-hinge bars in position, and the bottom bars of the arch barrel. Along the side, the commencement of the reinforcement of the spandrel wall can be seen, together with some of the top steel in the arch barrel.

*Fig. 321* shows the reinforcement of a fixed arch at its junction with the abutment. One-half of the abutment has already been concreted. The splice bars are seen temporarily supported on a timber trestle, the top part of this fitting into the hooks of the splice bars.

*Fig. 322* shows the assembly of some deep girders in a bridge construction. In this case a part of the side form has been placed in position, but in the manner suggested in an earlier paragraph the slab shuttering still remains to be carried out. The reinforcement was assembled in its final position. *Fig. 322* is a side view of one of the beams, the top of which is illustrated in *Fig. 323*.

*Fig. 324* shows the assembly of beam reinforcement in which coupling boxes have been used. Due to the number of bars requiring connection in this particular case, two couplings occur at the same section of the beam.

## CHAPTER XVI

### CONCRETE AND CONCRETING

CEMENT—SAND—COARSE AGGREGATE—WATER—TEST CUBES—PROPORTIONING—MIXING—TRANSPORTING—PLACING—CURING—REMEDYING DEFECTS

IN recent years there has been a tendency to concentrate on the advance of theoretical design in reinforced concrete, until to-day this has reached a high state of refinement. There is some doubt whether construction has advanced to the same degree, and yet a little consideration will show that this is really the most important part of reinforced concrete work. Calculations made about 1920, approximate as they were, nevertheless represented probably 70 per cent. of the truth, whilst those of to-day represent perhaps 90 per cent.; a relatively small advantage for the work entailed. Furthermore defects in reinforced concrete structures resulting from errors in design are comparatively rare, but the same cannot be said of construction. Even to-day bad construction joints, honeycombed concrete, rust spots, and so forth are met with far too frequently, and in every case they could have been avoided.

On the concrete depends not only a great part of the strength but also the permanency and the appearance of the finished work. These factors are of primary importance in any reinforced concrete structure, but are particularly important in bridge construction where the work is exposed to the elements. There is therefore no part of the construction of a reinforced concrete bridge which deserves more careful attention than that of concreting. For the best results the men employed, in addition to experience, should have a pride in the ultimate result of their labours. Haphazard methods in its preparation and placing are detrimental to the good name of concrete, and precautions should be taken to prevent them being adopted. Improvement in the quality of concrete produces a better structure. The following notes on concrete and concreting apply to concrete construction in general and to bridges in particular.

There are four materials used in the manufacture of concrete, namely, cement, sand, coarse aggregate, and water. An essential common to them all is cleanliness, not only on delivery to the site but up to such time as the material is placed in the work.

#### Cement.

Uniformity of cement is perhaps more important than attaining exceptionally high strengths in laboratory tests. The British Standards as revised from time to time specify the minimum requirements of good modern cements. In practice better results are usually obtained. For reference a summary of the



requirements of the B.S. No. 12 (1947) for ordinary and rapid-hardening Portland cement is given.

*Fineness.*—Residue by weight on a sieve of B.S. Mesh No. 170 shall not exceed 10 per cent. for ordinary Portland cement and 5 per cent. for rapid-hardening Portland cement. The specific fineness is also specified.

*Tensile test of cement mortar.*—Mortar : 1 part cement, 3 parts sand by weight. For ordinary Portland cement, the average breaking strength of six briquettes at 72 hours after gauging shall be not less than 300 lb. per square inch.; the average breaking strength of six briquettes at 7 days shall show an increase on the breaking strength at 3 days, and shall be at least 375 lb. per square inch. For rapid-hardening Portland cement the minimum strengths are 300 lb. per square inch at 24 hours and 450 lb. per square inch at 72 hours.

*Optional compressive stress* (in lieu of tensile test).—Mortar : as for tensile test ; test pieces : cubes with sides of 2.78 in. or 3 in. For ordinary Portland cement the average minimum compressive strength of 3 cubes shall be 1600 lb. per square inch at 72 hours and at 7 days there shall be an increase on the strength at 72 hours, and the strength shall be not less than 2500 lb. per square inch. For rapid-hardening cement the minimum strengths shall be 1600 lb. per square inch at 24 hours and 3500 lb. per square inch at 72 hours.

*Setting time.*—Using Vicat needle apparatus. For normal-setting cement the initial setting time must not be less than 30 minutes and the final setting time not more than 10 hours. For quick-setting cement these periods should be 5 minutes and 30 minutes respectively ; quick-setting cement should not be used on ordinary construction and is now excluded from the B.S. No. 12.

*Soundness.*—Using the Le Chatelier apparatus, the expansion shall not exceed 10 mm. (0.40 in.).

Portland blastfurnace cement, having between 35 per cent. and 65 per cent. slag content, is available in some parts of Britain. The requirements of B.S. No. 146 (1947) are the same as for ordinary Portland cement as regards fineness, tensile strength, setting times, soundness, and compressive strength.

High-alumina cement is not frequently employed on bridge construction, its use being limited to cases where high strength is required within a few hours, or where the concrete is subject to corrosive influences, or where concreting at low temperatures cannot be avoided. The requirements of B.S. No. 915 (1947) for this cement include a residue by weight on a No. 170 sieve of not more than 8 per cent., a total alumina content of not less than 32 per cent. by weight, compressive strengths of mortar cubes of not less than 6000 lb. per square inch at 24 hours and 7000 lb. per square inch at 72 hours, initial setting time between 2 hours and 6 hours, and final setting time not more than 2 hours after initial set.

When an engineer does not specify any particular brand of cement the general practice is to ascertain the brand proposed by the contractor and to have samples of this independently tested before work commences. If these tests show the cement to be satisfactory when used in conjunction with the aggregates proposed, the works test results provided by the manufacturer are generally accepted throughout for works of small size. On larger works, or in cases where a testing machine is easily available, the consignments as delivered to the site are tested to verify that a uniform material of specified quality is being supplied.

Cement, particularly rapid-hardening cements, should be used in the work as

soon as possible after dispatch. Storage, no matter how good the conditions either at the merchant's warehouse or on the works, should be reduced to the minimum, as it appears that the finer the cement the more susceptible it is to various influences, including age.

Considerable variation in results may be obtained by variations in the process of making test briquettes. Care should be taken to use the specific amount of mixing water and sand of the quality described in the appropriate British Standard. The specified amount of water and sand will give mixtures apparently too dry to work and too large in quantity to fill into the mould. By careful filling and vibrating of the mould, practically the whole quantity can be inserted and in addition a slight surplus of moisture will work to the top. Cubes of mortar should be made exactly in accordance with the method specified in B.S. No. 12. It is advisable for the cement testing throughout any work to be done by one man in order to eliminate the variations in manipulation which result if two or more participate in this work. Curing should be carried out by storing in moist air in the moulds for 24 hours and afterwards in clean water at 58 deg. to 64 deg. F. until tested.

In addition to these tests it is frequently of assistance to make rough tests of soundness at the site. These may be as follows :

(a) *Initial setting time.*—Make up a pat as for a briquette and note the time taken to resist the penetration of the thumb nail. This should be not more than 10 hours for normal-setting cement.

(b) *Soundness.*—On a glass base make a pat of cement paste, about 6 in. in diameter and tapering to the edges, and similar in consistency to that for a briquette. Allow it to rest for 24 hours and then place it in cold water, bring to boiling, and keep it so for three hours. The pat should remain perfect. Any cracking or crumbling denotes unsoundness, and use of the consignment represented by the sample should be deferred pending more accurate tests.

(c) *Coolness.*—Place the arm in a bag of cement. If cool it is probably in good condition. If hot it is fresh ; but recent tests show that there is no risk in using hot cement. If cold it may be stale.

### Sand.

Sand is the most doubtful ingredient in concrete. Ideally it should be perfectly free from impurities and be graded from material passing a  $\frac{3}{16}$ -in. mesh down to fines in accordance with the grading curve illustrated in *Fig. 325*. In practice these conditions are never entirely fulfilled ; but fortunately both are open to some variation without appreciable effect on the resulting concrete. The amount of foreign matter permissible depends on its nature. If it is comparatively pure inert silt, then the presence of up to approximately 5 per cent. is not likely to have any appreciable effect either on the strength or on the durability of the concrete, and in many cases even a little more than this is not a serious matter. If on the other hand the foreign matter is organic it is important that it should be excluded. If it is not excluded, action may develop after completion of the structure which may slowly produce decay. The sand may easily be tested for cleanliness by washing in a graduated glass measure and permitting the silt or foreign matter to settle. It is an advantage also to shake the water again and pass it through a filter paper in order to separate the silt.

This may then be subjected to microscopical or chemical examination to ascertain more accurately its nature and to form a conclusion of its effect on the concrete.

A simple test for the presence of organic matter consists of filling a medicine bottle to one-quarter of its depth with the sand and adding 3 per cent. caustic soda solution up to the three-quarters mark. This should be well shaken and left for twenty-four hours. If the liquid is then not darker than pale yellow,

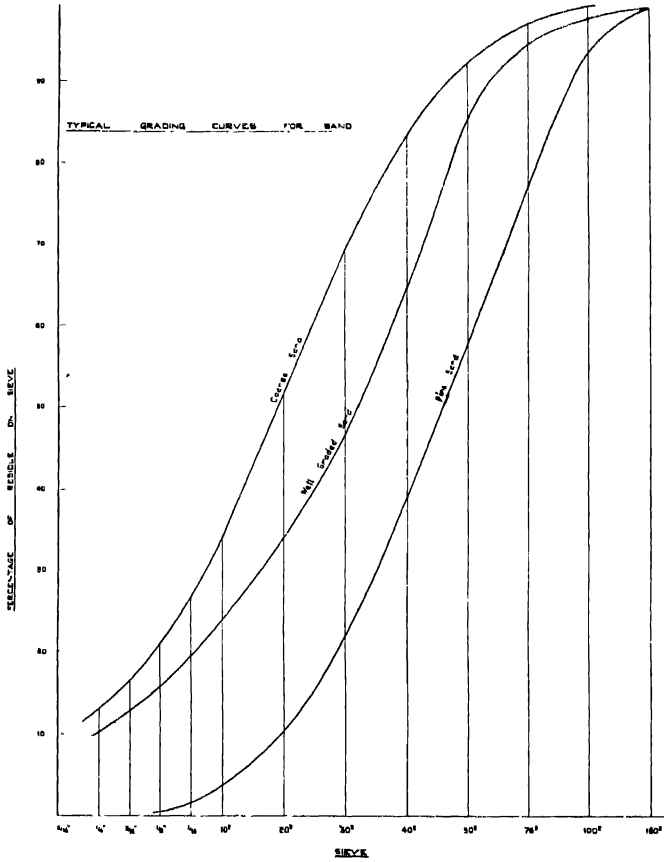

Fig. 325.

the amount of organic matter is small. If the solution becomes dark yellow the sand should be rejected or submitted for laboratory tests before use. Sand containing particles of coal or shell in appreciable quantities should not be used.

A test of the grading of sand necessitates the use of a set of sieves varying from  $\frac{3}{16}$  in. to 40 meshes per linear inch and measurement of the residue from any given sample on each sieve. The results should be plotted and judged in comparison with the ideal curve given in Fig. 325.

With a little practice the quality of sand may be fairly accurately judged by examination under a small pocket microscope magnifying 40 diameters. Grading, shape, material, and to some degree cleanliness, become apparent at this size ; the method has the advantage of easy application and makes possible a quick decision. This is particularly useful at the site during construction. In addition it is an advantage to make and test mortar produced with the cement and sand chosen.

An important point which is sometimes overlooked is the necessity for ensuring that the supply of sand available is likely to be uniform. Lack of uniformity in different deliveries is more serious than the presence of a small but uniform and constant percentage of foreign matter or for the material not being ideally graded. As a typical case, if the sand is obtained from a pit in which there is a top spit of material containing considerable quantities of loam, it is important to ensure that the material supplied for reinforced concrete work should be drawn from a part of the pit which is not liable under any circumstances, in dry or in wet weather, to be contaminated by the foreign matter in the top spit. Again, where river sand is supplied there may be sources of pollution only at certain times or seasons, or at certain places in the river bed. In such cases care should be taken to ensure that all the material delivered will be clean, or alternatively another source of supply should be obtained. The reason we stress the question of uniformity is that after a sample of sand has been approved it is impracticable to test every small batch and delivery. The most certain method of ensuring that all the sand delivered is suitable is to make sure that the source of supply of the approved sample is uniformly reliable.

### Coarse Aggregate.

The requirements of good coarse aggregate are that it shall be clean, tough, well graded from the maximum size specified down to  $\frac{3}{16}$  in., and that the supplies be uniform. Provided it meets with these requirements it matters little whether the aggregate be shingle, crushed shingle, crushed whin, crushed granite, or any of the other materials generally used for reinforced concrete work. With regard to cleanliness, coarse aggregates are not usually liable to the presence of foreign matter to the same degree as sands, but they are subject to another source of pollution, that is the dust produced when crushing them. This is particularly the case with whinstone, some types of which produce large proportions of fine dust or flour in the crushing. This dust is almost as fine as the cement, to which it acts as an adulterant, and in addition it tends to form a film on the faces of the particles of aggregate so preventing complete adhesion of the mortar. When such aggregate is delivered in loads at the site it will be found that the last portion of the material tipped contains a high proportion of dust. If, as may easily happen, this last portion is put into one batch of concrete, that particular batch is likely to be weaker than the average concrete in the work. It is difficult to obtain crushed stone perfectly free from dust. The only way apparently would be for the quarries to install dust extractors, but these are expensive and offer no appreciable advantage where the stone is used for purposes other than concrete. It is an advantage to visit the quarry and to emphasise the necessity for the delivery of clean material. Often it will help if the bins through which the material is supplied are cleaned out at intervals of say one week to remove any

large accumulations of dust from projecting internal ledges. Failing this, such accumulations fall at intervals and form bad pockets of aggregate quite unsuitable for concrete work.

With some aggregates it will be found that when concrete test cubes are broken the fracture occurs almost entirely as a result of the breaking down of

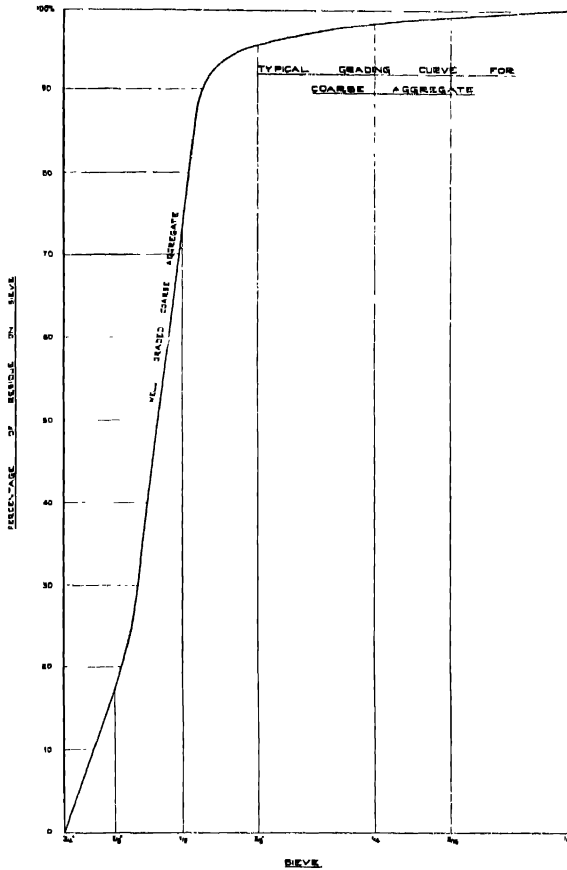

Fig. 326.

the adhesion between the mortar and the stone in the concrete. In other aggregates the break occurs as a fracture across the particles of aggregate throughout the concrete. In still further samples the fracture is approximately evenly divided between the breaking down of the adhesion and the fracture of the aggregate. In the first case it may be taken that the aggregate is really tougher than is necessary to provide concrete of the maximum possible strength with the mixture specified. In the second case the aggregate is not sufficiently

tough to produce the highest strength. The third case is probably the ideal in which the toughness of the aggregate approximates very closely to the adhesive properties of the mortar to the surface of the aggregate. When test cubes of the concrete proposed for use in the work are broken, careful observation should be made of these points with a view, if necessary, to either changing the type of aggregate or alternatively to adjusting the mixture of the mortar in the work to produce the maximum economical strength. Properly graded coarse aggregate is not so difficult to obtain as an ideal grading of sand; but it may frequently be necessary to explain carefully the requirements if the quarry manager is in the habit of supplying large quantities of material for roadwork where grading is not so important. If difficulty is found in obtaining correctly graded material this may be improved by specifying the aggregate in two sizes; that is, say, a proportion of  $\frac{3}{4}$  in. down to  $\frac{3}{8}$  in. and the balance in material  $\frac{3}{8}$  in. down to  $\frac{1}{4}$  in., particularly noting that these sizes must exclude dust or flour. A typical grading curve for coarse aggregate is shown in *Fig. 326*.

#### Water.

In practically all works in or adjacent to towns or cities it is possible to obtain water directly from supply mains, but in outlying districts the water may have to be obtained from other sources, such as a river, stream, or well. In general, drinking waters are suitable for use in reinforced concrete work, but this does not of course apply to all river waters. Where the water is not polluted by industrial waste, sewage, or peat it will probably be suitable for use, but it is always desirable to obtain information regarding the stream above the point from which the water is proposed to be drawn for the work. If after such an examination there is any doubt of the purity of the water it should be analysed before it is approved. In addition to cleanliness of the water in these temporary sources of supply, it is desirable to make sure when the work commences that the quantity of water passing down the stream will at all times be sufficient to provide for the works in question. It may also be found that in time of flood the river may bring down considerable quantities of silt or peat which may make the water temporarily unsuitable for use. In such cases it will be necessary to arrange for sufficient storage of pure water to carry on the works over any likely period of flood. These points are emphasised as neglect of them may occasionally have a serious effect on the quality of the finished work.

Finally, in regard to materials in general, the ultimate aim is the quality of concrete which they will produce. To this end the writers would strongly emphasise the desirability of having tests made, at the commencement of the work, of the materials it is proposed to use in the concrete in order to ensure that they will produce in combination a first-quality concrete. Samples of each of the approved materials should then be kept at the engineer's office and at the clerk of works' office in order that consignments as delivered at the site may be compared with them and the quality kept uniform with that approved.

#### Test Cubes.

Concrete test cubes should have 6-in. sides. Sometimes 4-in. cubes are used, but the writers prefer the larger cubes.

Cubes should be made in strong metal moulds whenever possible. These are expensive but produce dead true and parallel faces. If, however, wooden moulds are used they should be very carefully made. They are a cabinet-maker's job rather than a rough carpenter's. Metal moulds are often loaned by the cement manufacturers or the testing laboratories.

Cubes should be made from concrete as delivered from the mixer for use in the work and should be left in the moulds in damp air for 24 hours and then in damp sand at a temperature between 58 deg. and 64 deg. F. until two days before testing. After this period they should be allowed to dry.

Before testing, the cubes may be machine ground to dead true and parallel faces and this gives the best results. Frequently the faces of the blocks against the machine jaws are faced with plaster of Paris. If this is done care is still required to ensure dead true and parallel faces. Often the blocks receive no treatment and millboard is inserted between their faces and the jaws of the testing machine. The importance of true faces cannot be too strongly emphasised. If the faces are not true the pressure is first brought on the highest area and this crushes, the failure then spreading slowly to the remainder of the cube. Testing should be carefully watched for this phenomenon as if it develops the test result will not be an accurate indication of the strength of the concrete.

To enable the cause of unsatisfactory tests to be detected immediately, it being assumed that the water is already known to be suitable and the grading of the sand and aggregate satisfactory, and that the manufacture and curing of the cubes have been carried out as described, 4 sets of cubes should be made.

- (1) Cement, sand, and aggregate as proposed for the work.
- (2) Cement, washed sand, and unwashed aggregate.
- (3) Cement, washed sand, and washed aggregate.
- (4) Cement, unwashed sand, and washed aggregate.

The cubes (1) should be tested first and if satisfactory the expense of testing (2), (3) and (4) is unnecessary. If unsatisfactory, the additional tests should be made in the order given. Should all prove unsatisfactory the defect will probably be in the cement.

After much experience the writers find that this procedure is the only one which eliminates criticism by suppliers of materials. A further requirement is for cubes using unwashed sand to produce a strength at least 85 per cent. of that if similar sand is used after thorough washing.

### Proportioning.

Increasing interest is being taken in proportioning concrete materials but nevertheless the old standards of 1 : 2 : 4, 1 : 1½ : 3, 1 : 3 : 6, and so on, continue to form the basis of the majority of specifications. The proportions of concrete expressed in two terms such as 6 : 1, 4 : 1, etc., is so fundamentally bad that by now it is surely considered to be not only undesirable but dangerous by all likely to be responsible for specifying concrete for bridge work. The primary object in proportioning concrete is that the maximum amount of stone shall be introduced while ensuring that under practical working conditions there is sufficient mortar available to a little more than fill the voids in the stone. The first important factor, therefore, is the voids in the aggregate. It is for this reason one stresses the necessity for grading the coarse aggregate, for the better the

grading the smaller will be the percentage of voids and the smaller the amount of mortar required to produce a solid concrete. Voids may be measured by taking a container of known capacity, filling it with aggregate, and then adding water or dry sand completely to fill the voids, afterwards measuring the amount of added material. If water is used care must be taken thoroughly to soak the aggregate before commencing the test, otherwise it may absorb some of the added water and give a misleading result. If sand is used, considerable vibration will be necessary and care must be taken to ensure that the total bulk of aggregate is not increased.

In practice the variation of the percentage of voids is from approximately 33 per cent. up to about 50 per cent., the former occurring in gravel aggregates and the latter in aggregates of the nature of whinstone and granite, as indicated in *Table XXIV*. This variation in voids indicates the necessity for the proportions of concrete to be fixed according to the nature of the aggregate actually used in the work.

TABLE XXIV.  
VOIDS IN AGGREGATES.

| Material                 | Size<br>in.                     | Percentage<br>voids | Weight per<br>cu. ft.<br>(lb.) |
|--------------------------|---------------------------------|---------------------|--------------------------------|
| Granite chippings . . .  | $\frac{3}{4}$                   | 47.3                | 86                             |
| Crushed whinstone . . .  | $\frac{3}{4}$                   | 50.0                | 80                             |
| Do. . . . .              | $\frac{3}{4}$ to $\frac{1}{2}$  | 45.0                | 88                             |
| Crushed sandstone . . .  | 1 to $\frac{3}{4}$              | 39.3                | 85                             |
| Do. do. . . . .          | $\frac{1}{2}$                   | 44.4                | 78                             |
| Crushed limestone . . .  | 3 to 1                          | 41.0                | 77                             |
| Do. do. . . . .          | $1\frac{1}{2}$ to $\frac{1}{2}$ | 38.5                | 80                             |
| Broken brick . . . . .   | $1\frac{1}{2}$                  | 38.5                | 79                             |
| Thames ballast . . . . . | $1\frac{1}{2}$ to $\frac{3}{4}$ | 35.3                | 85                             |
| Do. do. . . . .          | 1 to $\frac{1}{2}$              | 37.5                | 82                             |
| Gravel . . . . .         | $\frac{3}{4}$ to $\frac{1}{2}$  | 34.8                | 90                             |
| Do. . . . .              | 1 to $\frac{1}{2}$              | 27.3                | 94                             |
| Sand . . . . .           | $\frac{1}{2}$ down              | 30.0                | 100                            |
| Mixed gravel and sand .  | ---                             | 23.2                | 105                            |

Consider the type of aggregate in which the voids are approximately 50 per cent. These voids may be measured in what may be termed "solid matter," that is in a material which itself contains no voids. But these voids are not filled with "solid" sand. Practically all sand when delivered at the site contains a certain percentage of moisture, and this causes a bulking which may reach a stage where 1 cu. ft. of what has been termed "solid" sand amounts to approximately  $1\frac{1}{2}$  cu. ft. of sand as delivered at the site. When more water is added this shrinks again until it arrives at a bulk approximately equal to that of perfectly dry sand. This shrinkage also takes place when cement and water are added to the sand to form the mortar in the concrete. If, therefore, the proportions specified are 1 : 2 : 4 the amount of mortar available to fill the 50 per cent. of interstices will be only about 40 per cent., whereas, as a matter of fact, in order to provide a sufficient surplus to allow for the difficulties of perfect ramming, it



should in such a case amount to not less than 60 per cent., that is allowing 10 per cent. of mortar over the actual voids in the aggregate. From this it will be realised that the indiscriminate specifying of concrete in which the ratio of sand to stone is as 1 : 2 is unsound, and is probably in some measure responsible for much of the honeycombed concrete which has been constructed in the past. The most serious case occurs when these proportions are indiscriminately specified for whinstone and crushed granite. They are usually more or less right in the case of gravel, and particularly of well-graded gravel.

The difficulty of deciding on the mixture of concrete to be used must be appreciated. As a rule, in his desire to preserve an open market, the engineer considers it inadvisable definitely to stipulate the sources of supply of sand, coarse aggregate, and cement. On the other hand, when he leaves his specification open for the contractor to choose the sources of supply he is not aware what materials will ultimately be proposed for use in the work, and is therefore unable to decide the best proportions required to produce a practical ideal concrete. His proportions are therefore based on surmise, and it is not until the contract has been signed and some material delivered at the work that he is able to decide the best practical proportions. By this time it may be difficult to alter the proportions specified, and on which the contractor has tendered, without some adjustment in the cost. To meet such cases it is suggested that the engineer may specify a particular mixture and include in the schedule for rates to cover variations from the specified mixture.

Finally, it should be specially noted that the proportions chosen for use at the site will seldom produce the maximum strength of concrete which may be obtained in a laboratory, due to the fact that a greater proportion of mortar will be provided than will give maximum strength. This increase of mortar, however, will produce under practical conditions a concrete which will permit of consolidation free from honeycombing or interstices when it is placed in the work.

### Mixing.

Concrete is nowadays generally mixed in batch machines, the majority of which are very efficient. Into them are placed for each batch certain definite quantities of the various materials, and the batch is discharged before a fresh batch of similar proportions is introduced. To ensure that the right proportions of materials shall be used throughout the work separate measuring boxes should be provided for the sand and the coarse aggregate. For cement, due to its bulking properties, measuring by volume is inaccurate and the only certain way is by weight. If it is not practicable to arrange for weighing on the site it is desirable to have the batches of concrete of such a size that they contain one or more bags of cement of known weight as delivered on the site. Where the size of such batch is too great for ease of handling in the work, then the batch may be of such a size as to take one-half bag of cement for alternate batches, the balance of the bag from the first batch being used for the second. This results in only negligible variations of the amount of cement in each batch. *Table XXV* gives the quantities of cement, sand, and stone required for 1 cu. yd. of concrete of practically every mixture likely to be used. They are given both by volume and by weight, and in addition quantities are given for sand and aggregate to

one bag of 112 lb. of cement for each of the mixtures. This table will be useful in calculating the amount of material to order and in arranging for gauge-boxes at the site.

TABLE XXV.

## QUANTITIES OF MATERIALS FOR DIFFERENT CONCRETE MIXTURES.

Cement : 90 lb. per cu. ft Sand (semi-dry) : 100 lb. per cu. ft., 30 per cent. voids.  
Coarse aggregate (graded  $\frac{3}{4}$  in. to  $\frac{1}{2}$  in.) 88 lb. per cu. ft., 45 per cent. voids.

| Mixture     | Quantities for 1 cu. yd. of concrete (by volume) |              |                          | Quantities for 1 cu. yd. of concrete (by weight) |          |                      | Quantities of sand and coarse aggregate to 112 lb. cement |                   |
|-------------|--|--------------|--------------------------|--|----------|----------------------|---|-------------------|
|             | Cement cu. ft.                                   | Sand cu. ft. | Coarse Aggregate cu. ft. | Cement lb.                                       | Sand lb. | Coarse Aggregate lb. | Sand cu. ft.  | Aggregate cu. ft. |
| 1 : 4 : 6   | 3.8  | 15.2         | 22.8                     | 342  | 1520     | 2006                 | 5.0   | 7.5               |
| 1 : 3 : 6   | 4.22   | 12.66        | 25.32                    | 380  | 1266     | 2228                 | 3.75  | 7.5               |
| 1 : 3 : 5   | 4.62   | 13.86        | 23.10                    | 416  | 1386     | 2033                 | 3.75  | 6.24              |
| 1 : 2½ : 5  | 4.91   | 12.27        | 24.55                    | 442  | 1227     | 2160                 | 3.12  | 6.24              |
| 1 : 3 : 4   | 5.1  | 15.3         | 20.4                     | 459  | 1530     | 1795                 | 3.75  | 5.0               |
| 1 : 2½ : 4  | 5.45   | 13.03        | 21.3                     | 491  | 1363     | 1918                 | 3.12  | 5.0               |
| 1 : 2 : 4   | 5.87   | 11.74        | 23.48                    | 528  | 1174     | 2066                 | 2.5   | 5.0               |
| 1 : 2½ : 3  | 6.14   | 15.35        | 18.42                    | 553  | 1535     | 1621                 | 3.42  | 3.75              |
| 1 : 2 : 3   | 6.67   | 13.33        | 20.00                    | 600  | 1333     | 1760                 | 2.5   | 3.75              |
| 1 : 1½ : 3  | 7.3  | 11.0         | 21.9                     | 657  | 1100     | 1927                 | 1.87  | 3.75              |
| 1 : 1¼ : 2½ | 8.3  | 10.4         | 20.8                     | 747  | 1040     | 1830                 | 1.56  | 3.12              |
| 1 : 2 : 2   | 7.7  | 15.4         | 15.4                     | 693  | 1540     | 1355                 | 2.5   | 2.5               |
| 1 : 1½ : 2  | 8.57   | 12.85        | 17.14                    | 771  | 1285     | 1508                 | 1.87  | 2.5               |
| 1 : 1 : 2   | 9.64   | 9.64         | 19.28                    | 868  | 964      | 1697                 | 1.25  | 2.5               |

The delivery of sand and coarse aggregate to the site ready mixed should not be permitted, as segregation and consequent lack of uniformity inevitably result. If for any special reason the practice is ever permitted it should be remembered that to one part of cement only the specified number of parts of aggregate should be taken in measuring the mixture of sand and aggregate. The sand, of course, is merely filling the interstices in the coarse aggregate; for example if 1 : 2 : 4 concrete is specified take only 4 parts of mixed sand and stone to 1 part of cement. If 6 parts of mixed aggregate are taken, then the mixture is really 1 : 3 : 6.

The time of mixing is not of appreciable importance within practical limits, but it will be found as a general rule that one batch every three minutes can be satisfactorily put through an efficient standard pattern mixer.

A much more important factor is the amount of water to be used. This will vary according to the condition in which the aggregate and sand are available at the site. If they are wet to commence with, then less water will be used. If they are perfectly dry, then a rather larger quantity of water will be necessary. It is in every case desirable, however, that the mixer be fitted with a water-measuring apparatus which will ensure the inspector's instructions with regard to the amount of water in the concrete being followed for periods of two

or three hours at a time. It will then be necessary to watch the concrete to ensure that if the coarse aggregate and sand are damp in the morning and become dry later in the day, or vice versa, the quantity of water may be adjusted to produce concrete of uniform quality. In general it should be taken as a working rule that the best amount of water to use in any concrete is the minimum amount which will produce concrete sufficiently plastic to work into the moulds and around the steel after adequate ramming without producing surplus water or an undue amount of slurry on the top of the wet concrete. The importance of the word minimum in this rule cannot be too strongly emphasised. How serious an effect deviation from the rule may have on the resulting concrete is well illustrated by *Table XXVI*. It is not possible to give the amount of water required for every case, but it will be some guide to state that for dry materials 1 : 2 : 4 concrete will require about 12 gall. to 9 cu. ft. of coarse aggregate, and 1 : 1 : 2 concrete about 9 gall. to 5 cu. ft. of aggregate. For wet materials the quantities would be about 9 gallons and 7 gallons respectively.

The slump test has been used as a gauge of the consistency of concrete, but experience shows that it produces varying results with different classes of aggregate and with different mixtures. In consequence it is better to decide the water content by personal observation as already noted. The use of the slump test, however, has a valuable moral effect in emphasising at the site the working rule already given. The slumps adopted must be settled from tests with the materials adopted for the work in each case, and these will depend on personal observation based on the general rule given.

TABLE XXVI.

COMPARATIVE EFFECT OF WATER CONTENT ON STRENGTH OF CONCRETE.

1 : 2 : 2 Concrete.

| Water content                      |                                  | Water-cement-<br>ratio | Crushing strength<br>lb per square inch |        |
|------------------------------------|----------------------------------|------------------------|---|--------|
| Gallons per cu. yd.<br>of concrete | Gallons per 112 lb.<br>of cement |                        | Cu ft water<br>Cu. ft. cement           | 7 days |
| 28.9                               | 4.67                             | 0.6                    | 4000                                    | 6000   |
| 36.0                               | 5.85                             | 0.75                   | 3100                                    | 4900   |
| 43.3                               | 7.0                              | 0.9                    | 2300                                    | 3900   |
| 50.5                               | 8.17                             | 1.05                   | 1700                                    | 3000   |
| 57.8                               | 9.34                             | 1.2                    | 1200                                    | 2100   |

Great care should be taken to see that the mixing stage and all plant used in the mixing and depositing of concrete are kept perfectly clean throughout the operations. Occasionally one sees heaps of "droppings" developing around the mixer, and now and again someone may clear up this material and deposit it amongst the fresh concrete with deleterious results. The inspector therefore should take care to see that the mixing stage is cleaned at frequent intervals as well as after each working period.

Occasionally, on very small work, hand mixing of concrete is resorted to.

It is usual to specify in such cases that an additional 10 per cent. of cement shall be added to the mixtures specified where machines are used, and that the materials shall be mixed three times dry and three times wet. Further, the mixing stage should be properly sheltered from the wind to prevent cement being blown away. When the materials are turned three times dry and three times wet they must really be turned over, and not simply pushed straight from one heap to the other. So far as mixing of concrete is concerned, very considerable developments have been made in recent years, and it is doubtful if the effectiveness of a modern mixer will be appreciably improved on.

### Transporting.

The transport of concrete from the mixer to the work may be by shovels, buckets, barrows, skips, chutes, chuting towers, pumps, or by a combination of these. Where shovels are used care should be taken that the distance from the stage where the material is mixed to the work into which it is delivered is not too far, or, say, not more than 8 ft. If the throw is long there is a possibility that an appreciable amount will miss its mark and be deposited in positions where it may be difficult to remove and cause damage to later work. In addition, and perhaps more important, the stones are liable to become separated from the mortar in the process of throwing. Where the distance from stage to work is greater than will permit placing by shovel, and where the quantity is very small, buckets are sometimes used. These form a very satisfactory method, and the use of them almost invariably results in careful work, for the materials are delivered in such small quantities that the men have ample time to pun each bucketful of concrete and so produce a thoroughly consolidated piece of work.

Where the quantities are larger and the distance greater barrows are used, and these generally necessitate the placing of the material into a barrow at the mixing stage, taking it to a further stage on to which the material is tipped, and after this it is shovelled into the moulds. Occasionally it is possible to tip the barrow loads directly into the work, but this should only be done where the members are large and the reinforcement widely distributed. The deposition of comparatively large quantities of concrete directly into the work is liable to induce considerably higher stresses in the shuttering, to cause vibration on parts of the work in which the concrete may already be partly set, and to displace the reinforcement assembled in the moulds.

Where still larger quantities and greater distances are involved the concrete is frequently tipped directly from the mixer into the skip of a crane, which then swings it round to a stage adjacent to the final position in the work. Where this method is used a watch should be kept at the delivery stage to ensure that the material is not becoming segregated during its journey and that it is entirely cleared batch by batch. Distribution of the concrete from the mixer to the place of deposition is often conveniently effected by dumpers as illustrated in *Fig. 327*. In excavations and similar places below the general mixing level chutes are often used down which the concrete slides by gravity into the work, or preferably on to a stage at the bottom of the chute. In such cases the chute should not be at an angle steeper than approximately 1 : 2, depending to some degree on the plasticity of the concrete. Care should also be taken to see that the chute is kept free and that there are no adhesions of partly-set concrete

throughout its length. If any segregation develops, then the concrete must be re-mixed on the lower stage. If any considerable quantity is to be deposited by this method a metal-lined or all-metal chute should be used.

On large work the concrete from the mixer is frequently hoisted up to the top of a tower from which chutes are arranged to deliver it into various parts of the work. This method has been highly developed in recent years, and it gives excellent results on works of sufficient magnitude. Great care is required in the erection of the plant and also in arranging that the angle of slope of the chute at no time exceeds approximately 40 deg. or less than approximately 25 deg. Variations outside these limits result in segregation of the coarse material from the mortar in the one case and in the concrete adhering to the chute in the other. An example of this type of equipment installed on the construction of a reinforced concrete viaduct is illustrated in *Fig. 328*.

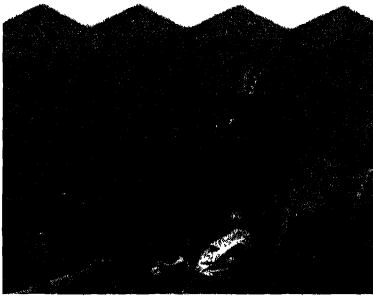

**Fig. 327.**—Transporting Concrete by Dumper.

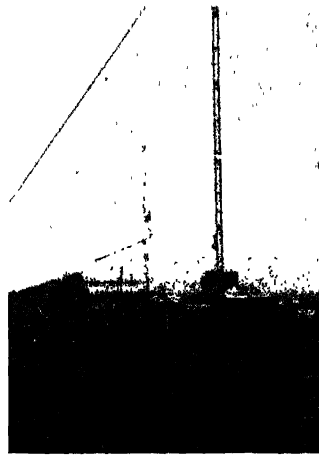

**Fig. 328.**—Placing Concrete by Chute.

It will be noted that in all these methods of transport the question of segregation of the large aggregate from the mortar is mentioned. It is, in fact, the most important factor to be taken into consideration when wet concrete is being transported. Provided arrangements are made by which there is no segregation the method of transportation to be adopted depends entirely on economy and suitability to the case in question.

During the 1930's a method of combining mixing and transport known as transit mixing was developed. In this method a lorry is fitted with a mixing drum which may be revolved by the lorry mechanism. The drum is filled with the necessary quantities of materials at a point some distance from the work and then commences on its journey to the site. For a portion of the journey the materials are mixed dry, and as the driver approaches the site he opens a valve which permits a given quantity of water to enter into the body of the

mixer and by the time he arrives at the site the concrete is mixed ready for deposition in the work. This method offers particular advantages on works in congested areas where it is difficult to store large supplies of raw material and to provide space for mixing plant.

The concrete pump as used in this country has a delivery pipe 5 in. in diameter, and the pump is driven by a 30-h.p. motor. The actual amount put through this pump is up to 24 cu. yd. per hour and the length of delivery pipe may be up to 2000 ft. with a lift from pump to delivery up to 130 ft.

### Placing.

As already stated concrete and concreting form perhaps the most important feature in reinforced concrete construction. It should now be added that placing the concrete in the shutters is the most important part of concreting. It is on this question of placing that the ultimate density and solidity, and in consequence the strength and permanency, of the work depend. If the placing is not carried out in a proper manner, then the concrete will be pinholed and honeycombed, its strength reduced and the elements permitted to reach the interior, whereas they should be excluded at the outer surface.

The first factor in placing concrete is that it should be deposited in its final position in comparatively small quantities. It is only by this means that efficient punning may be obtained, for if concrete is laid in deep and wide layers it cannot be nearly so well consolidated as when laid in thin and confined sections. This is a difficulty which is greatly accentuated in semi-mass and mass work. In such construction large quantities of concrete are required, and in order to get it into position without an undue number of construction planes, large and deep layers of material are laid at one time with the result that the material is not thoroughly rammed, punned, and consolidated. In reinforced concrete work, on the other hand, the quantities of concrete are comparatively small and are confined within definite and narrow boundaries by the shuttering, and in this work the concrete can more readily and certainly be made solid and free from interstices and pinholes. In practice few mass or semi-mass concrete walls 6 ft. thick will withstand even a small head of water without seepage unless given some surface lining, but a properly designed reinforced wall only a few inches thick will withstand a head of many feet without seepage.

The ramming and punning tools to be used depend on the volume of concrete to be placed in position. They may vary from a 10-lb. rammer in the case of mass work to a small rod having a blade measuring approximately 6 in. by 2 in. for work in small sections. Occasionally one sees attempts made to ram concrete with a straight rod about  $\frac{1}{2}$  in. diameter or with such a rod having a short right-angle bend at one end. These implements, although better than nothing, are not nearly so effective as a properly-bladed punning tool, and should not be allowed. In every case the workmen engaged on placing and ramming concrete should fully appreciate the responsibility which rests upon them to produce perfectly finished work. When this is fully appreciated there is seldom much difficulty in obtaining good results. Unfortunately, however, men are often placed on this class of work without its purpose having been explained to them, and think that all they need do is to raise the rod up and down so many

times per minute throughout the working day, a procedure not likely to produce interest in the work or sound concrete.

One of the great difficulties in the effective placing of concrete is the necessity of dividing the work by providing construction joints. These should never be permitted to "tail away," but should always be formed against temporary shutters. The reason is that where concrete tails away it is obviously impossible thoroughly to pun the upper surface of the tailed away portion as there is no solid support against which to ram. In consequence this surface will always, to a few inches deep, consist of more or less unsound concrete which in the finished work is certain either to give immediate trouble or to be detrimental to the permanency of the structure. In general, therefore, joints should be formed against a rigid vertical or slightly inclined shutter. For this purpose corrugated sheeting provides, in addition, a surface giving an excellent mechanical bond.

The production of good horizontal joints is more difficult, for two reasons. When punning a layer of concrete the material spews up around the punning tool which consolidates the material below but leaves a slightly less dense layer on top; in addition slurry and scum rise to the surface of every layer and form comparatively unsound concrete 1 to 3 in. deep on the top. Unless this is chipped away before further work commences, and the surface is moistened and coated with a layer of comparatively stiff mortar before proceeding, the defect will always remain. This difficulty is much greater in the case of semi-mass work than in reinforced concrete work, for not only are the horizontal joints much more numerous in larger work but, due to the quantity of concrete placed at one time, the amount of slurry is usually much greater. In order to produce good results with semi-mass work a definite mechanical bond should be provided between the layers. One way of doing this is to introduce steel rod dowels, but this often creates complications. An alternative method is to use clean "plums" of thoroughly sound stones, embedding the lower half in the first layer of concrete and permitting the upper half to project into the second layer. These form substantial dowels between the two layers, and are very effective. Where such plums are used care should be taken to ensure that they are not placed close together or close to any exposed surface of the concrete. Reasonable spacing is a clear 18 in. between any two plums and not less than 9 in. between the face of a plum and an outside face of concrete. In addition, it is advisable that the plums should not be too large, and for the usual types of semi-mass concrete bridge abutments and so forth their size should not exceed say 1 cu. ft. A further requirement is that they shall not be placed on a hollow bed, that is, with a concave surface on the underside of the plum, as in this event there is a risk of a hollow forming underneath the plum and so defeating the object for which it is used.

The position of construction joints should always be decided by the engineer. There is no doubt that much better work would result if the positions of all construction joints could be definitely shown on the detail drawings for reinforced concrete. The difficulty is that not until the drawings have been prepared is the engineer usually aware of the size of mixer and the amount of concrete which the contractor is likely to place per day in the work. If the engineer, having ascertained these facts, specifies to the contractor the positions in which

he wishes the construction joints to be formed, the finished work will be improved. To ensure authority to do this, the engineer should include a clause in his specification giving him power to make such an arrangement.

Finally it is important that all freshly-placed concrete be properly protected from the elements and from adverse influences. In bridge work an example of such an adverse influence occurs in the case of an estuary or river on which there may be a certain amount of floating oil, or of deleterious chemicals in the water. In such cases the specification should include a clause calling on the contractor to protect all immature concrete from the oil or chemicals until it has properly matured. Such protection is particularly important in the case of construction joints.

### Placing Concrete Under Water.

Whenever possible placing concrete under water should be avoided. Cofferdams in water of moderate depth, and cylinders, caissons, or piling in deep water, are the methods usually adopted for the construction of abutments and river piers. Where placing concrete in the dry is impracticable, however, the following procedure and precautions should be observed.

The common methods of depositing concrete under water are by tremies, bottom-opening skips, or bags. None of these is suitable for placing concrete around reinforcement, and precast reinforced concrete units bedded and bonded together in in-situ concrete under water are preferable.

A tremie is a device for the continuous deposition of concrete under water and consists of a hopper head which is kept above water level and from which a pipe extends to the river bed or other bottom upon which the concrete is to be placed. The pipe may be from 6 in. to 12 in. in diameter and the lower end is either open or preferably fitted with an outwardly-opening flap valve. The pipe should be empty of water before being filled with concrete and once filled with concrete should be maintained so by replenishing the hopper throughout the operation of placing the required amount of concrete, during which period the lower end of the pipe should be kept immersed in the deposited concrete.

A bottom-opening steel skip suspended from a crane is sometimes used in place of a tremie. The skip is slowly lowered through the water to rest on the bottom or on the concrete already in place. While being gently raised again the bottom flaps open and the concrete flows out. In this method the concrete falls or moves a few inches through the water, and consequently some of the cement and finer particles of sand may be washed out. Therefore a tremie should be used in preference to a skip.

Bagged concrete is suitable for protecting from scour a river bed around bridge piers, and for the protection from erosion of river banks near bridge abutments. A preferable alternative, if the sub-soil permits, is the provision of sheet-piled walls. In bagged concrete construction hessian bags or cement sacks are almost filled with fairly dry concrete and are laid in position to form the wall or other protective work. Header-and-stretcher or similar construction should be adopted to ensure bonding between the bags.

Concrete to be placed under water should be mixed as dry as is practicable, it should contain at least 6 cwt. of cement in each cubic yard, and it should not be placed when the temperature of the water is below 35 deg. F.



**Curing.**

After concrete has been placed in position it should receive attention for a period of seven to fourteen days. In the first place it should be protected from the effects of hot sun which may tend too rapidly to evaporate the water from the concrete and to leave insufficient moisture to permit the chemical actions to take place. This may in special cases of prolonged high temperatures call for the provision of awnings or tarpaulins. Generally, however, frequent watering meets the case. Curves showing the approximate increase in strength of concrete with age are given in *Fig. 329*.

Except at low temperatures, great advantages will accrue from watering

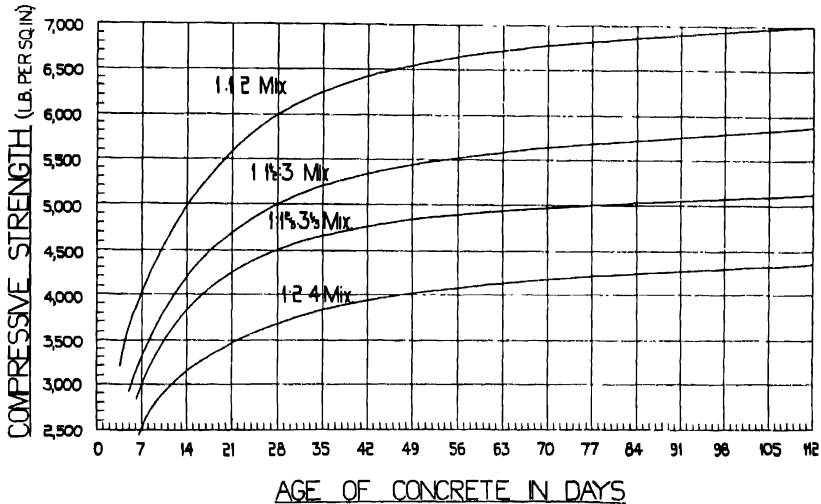

**Fig. 329.—Effect of Age on Strength of Concrete.**

the concrete for a period of seven to fourteen days after it has been placed. Not only will the strength of the resulting work be increased, but the tendency to the formation of shrinkage cracks will be appreciably reduced. Experience of concrete structures of many different kinds has definitely shown that watering the concrete is of greater advantage than is often appreciated, and is worthy of a special paragraph in the specification and a special item in the schedule of quantities.

The length of time the shutters should be left in position depends on many factors. In the first place the type of cement used may require the shutters to be left in position for not more than, say, two days in the case of high alumina cement to perhaps a month in the case of ordinary Portland cement. Rapid-hardening Portland cement will usually permit earlier stripping than if ordinary cement is used, but in cold weather or if the cement is not in a fresh condition, the question requires careful attention and the shuttering may need to be left in position for as long a period as when ordinary cement is used. On the other

hand, it is frequently possible to remove the shuttering earlier than is generally assumed from concrete for which ordinary cement has been used, due to the very considerable increase in the quality of such cements during recent years. Some idea of the time at which shutters may be stripped may be obtained from results of tests at, say, seven days on concrete cubes made with similar materials and under the same conditions as at the site. After this, the time when the shutters may be removed from the work may usually be decided by using a hammer or hammer and chisel to ascertain to what degree the concrete has hardened. For girder bridges having a span of, say, 50 ft. it is preferable to keep the props in position for at least three weeks, for girders up to, say, 20 ft. at least two weeks, but for slabs up to spans of approximately 12 ft. under normal setting conditions they can frequently be stripped with safety, even when ordinary cement is used, after seven days.

The worst enemy so far as curing is concerned is frost. The heaps of sand and stone must be protected from it before use and the new concrete protected from it for the first 14 days after placing. If the storage piles of sand and stone are covered with tarpaulins, and if after a somewhat cold night the sand and stone are drawn only from the inside of the heaps, less trouble will be experienced. In the setting action of concrete a certain amount of heat is generated which is usually sufficient to keep the material at a temperature above the danger point in moderately cold weather. If, however, the materials used with the cement are in a frozen condition when placed in the mixer the hardening of the concrete is materially retarded and may possibly become so slow as to be dangerous.

In addition to protection from frost, finished horizontal surfaces may require to be protected from rain for about 24 hours until hard. In every case immature concrete in a structure should also be kept free from vibration. After concreting has commenced the placing of further concrete should be arranged so that the work already placed is not subjected to vibration. This can be done by arranging the supports of barrow-ways over lines of props and by other precautions.

### **Remedying Defects.**

**ROUGH SURFACES.**—These are generally due either to the use of rough boarding or of dressed boarding which has been previously used and not properly cleaned. The most satisfactory way of dealing with this defect is to rub down the face with carborundum blocks. Grout may sometimes also be rubbed into the surface, but its effect is not usually permanent nor is it attractive. Another cause of the trouble is the use of dry boarding, which tends to absorb too much moisture from the face of the concrete.

**BULGING.**—Bulging is due to the soldiers being too far apart, the boarding being too thin for its purpose, or the supports being unstable. Bulging may take place either slowly as the load of wet concrete is increased, or suddenly due to defects in the supports. In the former case the work may perhaps be sound though unsightly. Where the movement is sudden, however, damage is almost sure to result either internally or externally and in the majority of such cases the work will require to be demolished and reconstructed. It is almost impossible satisfactorily to remove a bulge from the face of concrete work, for two reasons. In the first place the chipping off of surplus concrete may reduce the cover of the reinforcement to such a degree that it may affect its permanency. Second,

even if this does not occur it is very difficult to make good the surface which has been chipped without at the same time showing a bad patch on the face of the concrete. Generally, therefore, even where a bulge occurs slowly during the placing of the concrete, it is better either to have the defective work demolished and rebuilt, or to leave the defect in. If it is left, investigation should be made to ensure that the movement of the shuttering has not affected adjacent work.

**PIN-HOLES.**—Pin-holes in the face of concrete work are usually due to insufficient ramming, or to the use of shuttering which is too dry and absorbs moisture from the surface of the concrete. Pin-holes alone may be filled with mortar, or the face may be rubbed down with a carborundum block and cement grout.

**HONEYCOMBING.**—Honeycombing is due usually to one of three causes: (a) At the end of a batch of concrete the coarse material may have become segregated from the mortar; (b) There may be a leakage of the mortar through the joints of the shuttering, so leaving insufficient in the concrete adjacent to the joint to give a good face; (c) In the case of horizontal joints the top surface of the lower lift of concrete may not have been chipped, moistened, and treated with cement mortar before carrying on with the further work.

Investigation should be made to ascertain the depth of the honeycombing. If it is not more than one inch deep then it may be thoroughly cleaned, moistened, and rendered over, although the result will show a patch on the finished work. If, however, the honeycombing goes deeply into the work and there are comparatively loose pieces of aggregate, it is advisable to demolish and rebuild the work, or if work above has proceeded too far to permit of this it may be grouted under pressure. To carry this out the defective surface should be rendered over and allowed to set. Pipe connections should be built in through the rendering and the pressure grouting attachment made to them. Grout should be forced in until it is impossible to force in more. If the depth of the honeycomb face is shallow, say not more than 12 in., then the grouting pipe should be fixed near the top in order that the grout will run down through the full thickness. If the depth is greater than this, then grouting pipes should be fixed at intervals of approximately 12 in. in the height of the defective work and the grouting carried out by steps, observation being made at each step to verify that the work below has been thoroughly solidified.

**BOARD MARKS.**—Whilst there is almost invariably some indication of board marks in concrete work, excessive marking and an unsightly finish often result from unjustifiable irregularities in the shuttering. This may be due to bad workmanship in making up the shutters, or to the shuttering warping after being left too long in position exposed to the elements. It may also result from the boarding being too thin and deflecting irregularly under the pressure of wet concrete. In these cases small projecting ridges may be chipped off, the whole of the work rubbed down with carborundum blocks, and, if considered advisable, grout rubbed in.

Generally defects in concrete cannot be treated to produce a result so good as originally sound work. Furthermore, the making good of such defects is both tedious and expensive. It is therefore desirable to avoid them entirely, and this can be done by the exercise of care and by the adoption of the several suggestions made in this chapter.

## CHAPTER XVII

### SUPERVISION OF CONSTRUCTION

DUTIES OF RESIDENT ENGINEER—EXCAVATION—MATERIALS—MIXING  
CONCRETE—FIXING STEEL—SHUTTERING—CONCRETING—CURING—  
MEASUREMENT

#### **Duties of the Resident Engineer.**

THE duty of a resident engineer or clerk of works is to act as the representative of the client at the site and to ensure that the specifications, drawings, and any other documents supplied by the engineer are interpreted throughout in full accordance with the engineer's intentions. If the resident engineer adopts the attitude that the work is being done for himself, and if his actions throughout are based on this attitude, then his work will be well done. He will find that this attitude will lead him not only to ensure that the work is done in accordance with the engineer's intentions, but also to help both the engineer and the contractor as much as possible in the carrying out of their respective duties. They both have their duties to perform, and each should be of assistance to the other in performing those duties, keeping in mind throughout that "it is the work that matters." If this spirit of mutual helpfulness is adopted not only is the work likely to be carried out in a far better manner, but it is likely to be carried out in a more economical way.

A clerk of works or resident engineer on taking over his duties should be given a complete set of the drawings for the work, a copy of the specification, and a copy of the quantities, the last, except in special circumstances, being a priced copy. He may with advantage first study the drawings carefully, noting as he goes through them any points which are not quite clear to him, any apparent lack of information on the drawings, and any items which may not appear to him to agree as between drawings, specifications and quantities. He may then proceed to study the specification in detail so that he may obtain a more clear understanding of the materials the engineer proposes to use and their respective qualities. The copy of the quantities will assist him in the study of the other documents, but for the time being it may not be so important as the drawings and the specification. Having gone through these documents he should see the engineer and obtain from him information on all doubtful matters and any additional information and instructions which are necessary to enable him to interpret the engineer's requirements accurately.

On taking up his duties at the site of the work he should note and record in detail the existing conditions. Unless already done, this will include a complete level survey of the site to facilitate the calculation of quantities of excavation and

similar work, and also the recording of items which may perhaps be interfered with during progress of the work and which may require to be made good on completion. In such cases it will be necessary for him to note their present condition. For this purpose a camera is useful, and in fact a clerk of works or resident engineer usually finds a camera of great assistance if used discriminately at the beginning of the work and throughout construction.

It is necessary for the resident engineer to obtain the agreement of the contractor's engineering representative to all these preliminary figures and particulars. This may avoid disputes at a later period when it becomes necessary to go into the question of final measurement for works affected by such records.

### **Excavation.**

So far as the actual carrying out of the excavation is concerned it is only necessary for the resident engineer to check the contractor's setting-out, or alternatively for the contractor to check the engineer's setting-out, whichever may be the instruction in the contract. He may, however, also verify that sufficient room is being left in the excavations to permit of the erection of shuttering and the proper finishing of any concrete which is to be constructed inside the excavation. He should also verify that any pumping equipment installed is sufficient to keep down the water, and that the sump is carried to a sufficiently low level to ensure that the foundations will be constructed on a dry bottom. As a general rule the resident engineer's position is not such as to enable him to dictate to the contractor what size of pump he is to put in an excavation, and his comments on such points should generally consist of helpful suggestions rather than actual instructions to increase pumping plant. Usually it is only when the contractor is cleaning the bottom of the excavation preparatory to concreting that the resident engineer finds that the equipment is insufficient to deal satisfactorily with the water and that he has power to issue instructions and if necessary to forbid concreting until the contractor adjusts his pumping installation so as to permit concreting to be carried on without interference from ground water. Throughout the excavation the resident engineer should keep the engineer advised of the nature of the ground being encountered, and particularly and in greater detail when it varies from that previously disclosed by bores or trial pits. When it becomes evident that the excavation is nearing the foundation level the resident engineer should advise the engineer in ample time so that he can be in attendance when the excavation is cleaned out to give either his approval or further instructions. In some cases the duty of approving the foundation is left to the resident engineer, but this is usually far too important a decision to be made by anyone but the engineer responsible for the work. When the resident engineer has seen part of the subfoundation passed by the engineer, and has thus seen an example of what the engineer is willing to approve, then it is perhaps reasonable for the engineer to empower him to approve further excavations. It should be noted, however, that if at any time the resident engineer has the slightest doubt whether the foundation is suitable for the work he should refer the matter to the engineer for decision rather than make one himself whilst still in doubt.

If boulders are encountered in the course of excavation the resident engineer should note them and agree with the contractor on their volume and any other particulars which may be necessary to deal with the payment for removal in

accordance with the specification and quantities. When an excavation is carried down to rock it will usually be found that before bed rock is reached there is a stratum of what is termed rotten rock, which it may be necessary to remove before the foundations are commenced. Often the specification and quantities allow for some additional payment for the removal of such rotten rock, and if this is the case it is important that the resident engineer should agree with the contractor as the excavations are opened out at what levels the additional cost will be payable. If they cannot agree then each should take his own records, and the resident engineer should obtain typical samples of the material being removed at various levels and refer the matter to the engineer as early as possible so as to ensure that a settlement is reached before the excavation is filled in. If this is not done the whole question is left to surmise and diverse opinions which make it difficult to arrive at an amicable settlement later.

Occasionally in excavations old piles, the foundations of earlier work, or other obstructions are encountered, which were not anticipated at the time the contract documents were prepared. In such cases either a price for removal may be agreed with the contractor or the work may be carried out at day-work prices. In either case it will be necessary for the resident engineer to keep full notes so that he may check any accounts submitted for the work. He should also note where any old drains are intersected and either himself or in collaboration with the engineer arrange for their diversion and the preservation of the drainage in a condition at least equal to that in existence before the new work was commenced.

Generally with regard to excavations and work connected therewith the resident engineer should keep in mind that it is the part of the scheme in which most variation from the contract documents may be expected, and, that being the case, it is the part which calls for the most careful and accurate records as it is carried out.

### Materials.

Whilst the excavations are proceeding materials for the permanent work will usually be delivered to the site. These should be inspected as delivered and tests made as described in Chapter XVI. For this purpose the resident engineer should be provided with a set of sieves for testing the grading of both sand and coarse aggregate, measuring glasses, briquette moulds, steel moulds for making concrete cubes, and, in some cases, on works of sufficient size, with a cement and concrete testing machine.

**Cement.**—Apart from the usual site tests and the preparation of specimens for laboratory tests, the resident engineer should obtain the works test sheets for examination and approval. He should also verify that the shed in which the cement is to be stored is weather-tight and is suitable for its purpose, and he must take precautions to ensure that the cement is not simply stacked into this shed and used from the top of the stack every time. Cement should be used in the work in the order in which it is delivered to the site. This is not always a simple matter and it depends on the arrangements at the site what precautions should be taken to ensure that consignments are completely used in the order of their delivery. Some specifications require that the cement shall not be stored for more than a certain period, and if so arrangements must be made to ensure

that this stipulation is complied with. On the mixing stage "caking" of the cement as emptied from the bags and the presence of any partly-set pieces should be looked for. If such appear then the bag of cement should either be condemned or put aside for further investigation.

**Sand.**—The resident engineer's duties include the inspection of the sources of the supply of sand from time to time to ensure that suitable material is available in ample quantities and that the material for the work is being drawn from the best positions. On arrival of consignments of the material at the site he should test them for cleanliness from time to time and make site tests for organic matter, grading, etc., as described in Chapter XVI.

There is a tendency on some works to heap the sand in any convenient place without taking care that the area on which it is dumped is suitable, clean, and likely to remain so. If necessary the resident engineer should insist on a stage being made on which the sand may be dumped to ensure that it is kept clean; failing this other measures may be taken. In some cases the sand near the bottom of the heap is formed into a bed for the deposition of the sand actually for use in the work. It is obviously more satisfactory, however, to use old boarding for this purpose, and so avoid the waste of the considerable quantity of sand required to form such a bed, and which will still involve risk of contaminated material being gathered up and used in the work.

**Coarse Aggregate.**—The stone as delivered to the site should be examined for cleanliness, freedom from dust or flour, grading, and quality. It should be tipped in a position where contamination will be avoided, as noted for the sand.

**Water.**—Where the water supply is from a main the resident engineer will have no trouble except that he may be called on to assist in negotiations with the water authority for the supply to the work. If the water is drawn from any other source, such as a well, a river, or stream, the attention of the engineer should be drawn to it and his approval or instructions obtained and worked to.

### Mixing Concrete.

In addition to these items the resident engineer should ensure that separate measuring boxes are provided for sand and stone, and make sure that these are of the correct sizes to suit the mixtures specified. A divided measuring box for sand and stone is undesirable. During mixing of the concrete he should ensure that conditions are such that cement is not blown away or lost by other means and that the concrete is left in the mixer for a sufficient length of time to ensure proper mixing. A point the resident engineer should pay particular attention to is that of water content and the consistency of the concrete. It is impossible to lay down any general definite and practical rule on the quantity of water required in any particular mixture of concrete to produce the best result. It will vary with the proportions, the types of sand and stone and with their moisture content on delivery to the mixer. It will be necessary in every case to test the amount of water that should be added. He may test the result by the slump test, although an experienced man will usually be able to judge best as the materials are being put into the work whether the amount of water is the most suitable or not. It is correct to use in the concrete the absolute minimum quantity of water which will produce a mixture of such a consistency that it has the maximum stiffness which will permit of it being worked into the position for which it is

intended and produce a solid concrete free from interstices or pin-holes. He should insist on a water-measuring apparatus being attached to the mixer so that he can definitely decide from time to time the amount to be used in order to keep the consistency uniform between his tests.

So far as transport is concerned the two main points which require attention are that no segregation of the materials in the concrete takes place during transport and that the transport of the fresh concrete does not damage by vibration or otherwise any work already placed. The resident engineer should also ensure that no wet concrete falls into positions where it will be difficult to clear away at a later date, and which may possibly prove detrimental to later work. This applies particularly to adjacent reinforcement the adhesion of which may be reduced in the finished work if it becomes coated with "droppings" before it is concreted in.

### Test Cubes.

The resident engineer, as soon as possible after deliveries of materials commence, should make test cubes of the concrete mixtures proposed. As a rule three cubes are required in each of two sets, one set for testing at 7 days, and the other at 28 days in order to verify that a proper increase in strength has been obtained. Whenever cubes are made great care should be taken to mark them clearly so that the marks will not be removed during transport. This may be done by scoring the upper surface of the cubes while they are soft and marking them with the necessary reference and the date of manufacture. This is probably the most satisfactory way. Some engineers, however, object to the cubes being interfered with in any way, and in such cases they should be marked with paint immediately on stripping the moulds. Care should be taken that the cubes are properly cured as described in Chapter XVI. Cases are known where defective curing at the site or careless handling during curing has been the cause of poor test results, and these poor results have given considerable trouble to all connected with the work pending further tests being carried out. As an example, a poor test result was definitely traced to the moving of the cubes by the office cleaner before they had properly set.

### Reinforcement.

On all except large works it is usual to accept the mill's test sheets in regard to reinforcement steel, although the British Standard specification allows the resident engineer to visit the steel works and have specimens taken from the consignments intended for the site tested in his presence. He should keep a record of all test sheets received and of any tests which are made under his observation. If at any time he is doubtful of the quality of material being supplied, perhaps as a result of the behaviour of the steel during bending, he should arrange for a set of tests to be made in collaboration with the engineer for the works.

If steel is delivered directly from the mill and is to be used fairly soon after delivery it is better to store it in the open so that it may weather and the mill scale be removed. Mill scale adhering to a bar does not permit of proper adhesion of the steel to the concrete, and arrangements should always be made for it to be removed either naturally by the elements or artificially by pickling before it is placed in the work. If it is necessary to pickle the bars it will also be necessary



to neutralise the pickling medium before the bars are used. Such processes are comparatively tedious and costly for the contractor, and in consequence the steel should be ordered early enough to permit of proper weathering and scaling off of the mill scale naturally before it is necessary to use the material in the work. On the other hand it is necessary for the resident engineer to see that so much steel is not delivered and stored in the open as to permit rust scale developing before the material can be used. If the contractor wishes to obtain large deliveries at one time there is no reason why he should not do so if he arranges to store under cover the bars not required for a long period. The resident engineer should see that the bars are kept free from clay, grease, and other material which may tend to destroy the adhesion between the bars and the concrete.

Generally bars are bent cold and no heating of the bars should be permitted except perhaps for small quantities of large sizes of mild steel bars, say over  $1\frac{1}{4}$  in. The usual bending machine will bend bars up to  $1\frac{1}{4}$  in. diameter cold, but in some cases it may be necessary to use bars of a larger diameter. If only a few of these are required the resident engineer may approve of them being bent at a red heat and cooled slowly, subject to a competent man being employed to do the work. If, however, many large-diameter bars are required the contractor should be instructed to supply a bending machine capable of bending the bars cold.

In some cases where extremely long lengths of bar are required turn-buckles or unions to join two lengths of bars together may be specified. These will entail right-hand and left-hand threading of the ends of bars. In such cases the ends of the bars for a length of 9 in. to 12 in. are increased over the normal diameter in order that when the thread is cut the diameter at the root will be at least equal to the normal diameter of the bar. This operation is usually carried out in a machine shop, in which case the resident engineer should verify that it is being done in a proper manner. Sometimes a sufficient length of the bar is heated and knocked up into a ball from which the increased diameter is drawn out. This should not be permitted, as it tends to form a bar of poor quality or perhaps even with a hollow core. Instead, an "upsetting" machine should be used and short lengths of the bar heated at a time, commencing at the root of the upset and slowly working toward the end of the bar. By adopting this method a hard end of steel is left until the last, against which the hammer can be used to knock up the heated portion of the bar. The shape of the upset at the root and the diameter of the upset is formed by working the heated bar in tongs or cress of the correct size. The heat at which this work should be carried out is a good pink heat.

### Fixing Steel.

The resident engineer should ascertain what arrangements the steel fixers propose to adopt to ensure the rigidity of the steel in the moulds, and should approve these or otherwise as the work proceeds rather than leave any considerable portion of the work to be assembled before inspecting it. This will avoid delay and difficulty. He should verify that the wiring of the bars is adequate to keep them in position during concreting, and that the loose ends of all binding wires are turned in towards the body of the work. He should also verify that the cover to the reinforcing bars is in accordance with the drawings, and that proper measures have been taken to preserve this cover throughout the placing of the concrete. In beams and girders this is usually done by hanging the reinforcement

from the top and propping out from the sides with removable wedges, but any method may be adopted which gives rigidity and which at the same time leaves the cover unimpaired after the shuttering is removed. A case which requires particular attention is that of a bar held at the base in a comparatively shallow foundation but with a long length projecting upward to be embodied in later work. This may occur in a wall that spans vertically, and particularly in a cantilever retaining wall in which the vertical bars in the wall are carried to some height up the stem. In such a case it is important for the resident engineer to ensure that adequate strutting and support are given to such bars near the top in order to prevent them vibrating during the work. If they are permitted to wave about it is obvious that towards the top of each layer of concrete their adhesion will be impaired.

### Shuttering.

The first factor to consider in connection with the shuttering is that it is correctly aligned; the second is that the material has sufficient strength and thickness to avoid bulging or movement during construction. This can be verified by simple calculations as described in Chapter XIV, or alternatively making use of suitable tables of strengths of shuttering. For special cases the resident engineer may refer the contractor's proposals to the engineer so that he may make more elaborate calculations to verify that this work will be sufficiently stiff. Usually, however, a resident engineer will be able to tell by inspection in ordinary cases whether the shuttering is sufficiently stiff or not. The third point is that the joints in the boarding must be sufficiently tight to prevent any loss of mortar from the concrete. This does not necessarily entail tongue-and-groove joints which, in fact, where shuttering is to be re-used are often more a nuisance than an assistance, but it does entail shot edges to all boarding.

Another point which calls for attention is that the supports of any centering should preclude settlement under the load from the wet concrete. Settlements during the deposition and setting periods can be extremely serious and may perhaps necessitate the demolition of the new work. In the case of bridge work it may perhaps be necessary even to drive piles to support the centering, or where the ground is firm enough and is not under water it may be necessary to use concrete bases for the temporary staging.

In the course of supervising the shuttering the resident engineer should also verify that adequate attention is paid to the necessity of simplifying stripping to avoid damage to immature concrete. He should also ensure that the shuttering is properly treated either with grease, limewash, or other preparation to prevent adhesion of the concrete to the boarding.

A further point, and one which is sometimes overlooked, is the necessity for arranging the shuttering so that chips, shavings, or rubbish of any kind can be cleared out immediately before concreting. This is particularly important in the case of deep beams containing such quantities of reinforcement that it is impossible to get a brush or other similar tool to the bottom and where it will probably be found necessary to wash out the moulds with a hose before concreting. In shuttering for piers and columns it is advisable to leave out one board at the bottom of one side in order that it may be cleaned out with a brush before

concreting. This board should be carefully fixed immediately before concreting commences.

### **Concreting.**

Immediately before concreting commences the resident engineer should go over the work to see that the shuttering is clean, properly greased, and that it is adjusted to the proper line, that all wedges and props are tight, that the steel is correctly fixed in position to give the correct cover, and that the shuttering is sufficiently rigid to avoid movement during concreting. He should also verify that the stone and sand are clean and in proper condition, and particularly that they are not frozen. In addition, where a certain part of the work is to be carried out in one operation, he should check that adequate supplies of material are available to permit this being done; if not, concreting should be postponed until the stocks are increased. During the placing he should verify that an adequate number of men is employed on ramming, and that the materials are not being segregated in transit. He should also arrange to avoid vibration of the finished or partly-finished work before the concrete has matured. He will frequently be called on to decide the position of construction joints, and he should not under any circumstances permit concreting to be tailed off but should always insist on it being stopped against a vertical board, including any grooving or other bond he may consider necessary or as the engineer may specify. Corrugated sheeting frequently provides a good method of forming a joint to give a definite mechanical bond at the end of a day's work. Finally, the resident engineer should remember that on the concreting operations depends the strength, the appearance, and the permanency of the finished work, and it is therefore particularly important that these operations should receive his closest attention.

### **Curing.**

After the concrete has been placed care should be taken to protect it as necessary from either frost or rain until such time as it is immune from their influences. Protection from the sun can usually be arranged by watering immediately after the initial set has taken place, or in extreme cases by covering with tarpaulins. In the case of frost, where this is slight the work may be protected by covering with bags or clean straw, but where the frost is keen and extends over some days it may be necessary for braziers to be supplied. Where this is done precautions must be taken to avoid risk of fire, and it will be necessary to employ watchmen for this purpose. Except during frost, after the concrete has been placed in position, and usually for seven days, it should be kept moist. This requirement is included in most specifications, but it is seldom implemented with the thoroughness which it deserves. There are cases, for example beams, where it is impossible to water the concrete until the side shutters are removed, but immediately it is possible to do so the resident engineer should insist that this important provision be carried out. If the work is sufficiently large it is advisable to arrange for a man to be continually employed on watering. The resident engineer must of course use discretion when there is a possibility of frost, as it would be obviously detrimental to the work to wet it during the day and to have the outer wet surface frozen at night. He should also see that during curing

the immature concrete is well protected from any shocks which might cause disintegration of the work.

The resident engineer, as already stated, should verify that as the shuttering is erected it is so arranged that it can be easily stripped without disturbance of the finished work. Generally side shutters from beans, or any shuttering which is not supporting a weight of concrete, may be removed first. Before this is done the engineer should go over the exposed faces of the concrete and test them with a hammer and chisel to verify that the concrete has properly set. In testing with a hammer the work should give a clear ring; any sound of dullness indicates that the work is not sufficiently hard. When testing in this way the engineer will require to differentiate between the sound which he will obtain from, say, the middle of the span of a deep girder and the sound from that member close up to its support, or the ring which he will obtain on a deck or arch slab. The ring is similar, that is, comparatively clear, but the volume of it will vary. Having decided that the shuttering may be stripped the resident engineer should supervise the easing off of the wedges and the taking down of the supports. After removal of the shuttering he should examine the surface of the concrete for any defects and have them dealt with in the manner described in Chapter XVI. If the work is to be bush hammered, then commencement of this should not be permitted until the concrete is really hard. It is of course easier to carry this out whilst the concrete is comparatively immature, but there is then a much greater tendency to disintegrate the work and a better and cleaner result is obtained by leaving the work to mature at least a month before commencing bush hammering.

In addition to the construction of the reinforced concrete work there will be other items for the resident engineer to inspect, such as earth filling. Where it is important that the minimum settlement shall take place the use of mechanical rammers is recommended. In placing filling the question of land drainage is particularly important, and it is often within the duties of the resident engineer to make arrangements for this.

### Measurement.

Generally measurements of completed work are taken monthly. These should be recorded in a proper form, and not only the final results but also the taking-off figures in each case should be retained so that they may be referred to when required. Wherever possible the quantities for any work should be agreed with the contractor as each portion is completed. It is far better to do this whilst the matter is fresh in the minds of those dealing with it than to leave it for a period of perhaps twelve months or more, by which time some of those interested in the work may not be available and even if available their recollection is not likely to be so clear.

It is desirable also for the resident engineer to keep a progress record throughout the work, together with records of the weather from day to day. These may be kept in a diary, but in addition the progress can be shown graphically on drawings or charts in a manner which is useful to all connected with the work. The main advantage of this graphical progress record is that it shows immediately the date on which any particular portion of the work was concreted, and by inference the reasonable date on which this part of the work can be stripped and when it can be placed in service.

## CHAPTER XVIII

### SPECIAL FEATURES

RAILWAY BRIDGES—CULVERTS AND SUBWAYS—PRECAST CONCRETE  
BRIDGES—JACKING ARCHES—TEMPORARY HINGES—PERMANENT HINGES,  
BEARINGS AND JOINTS—DRAINAGE AND WATERPROOFING—WIND PRESSURE  
ON BRIDGES—TESTING AND MAINTENANCE OF BRIDGES—PLAIN CONCRETE  
BRIDGES

#### Railway Bridges.

IN addition to the constructional difficulties imposed by the necessity to maintain railway services during the erection of over-line or under-line bridges, there are in the latter type of bridges a number of design factors that do not appertain to other bridges, or do so in a negligible degree. Apart from the stresses due to dead load, live load, changes of temperature, shrinkage, and wind pressure, in the case of under-line bridges the effects of lurching and longitudinal forces must be considered, and in the case of a bridge on a curve the centrifugal forces must also be considered. Impact is also more serious on a bridge carrying steam locomotives than on one designed for road traffic or for electric trains.

**IMPACT AND LURCHING.**—Impact can be greatly reduced by the provision of an adequate thickness of ballasting under the tracks, and such cushioning is most necessary to reduce noisy and hard running. The impact effect due to rail joints, irregularities in the track, and hammer-blow from locomotives are not determinable accurately. The live load will usually be specified by the railway owners in the form of a series of axle loads to which the addition of an impact factor is necessary. An approximate impact factor to allow for rail joints and irregularities in the track and the wheels, and suitable for conditions comparable

to main lines in Britain, is given by  $\frac{I}{0.15L + 3}$  where  $L$  is the span of a longitudinal

main beam or twice the distance apart of transverse beams. For tracks laid and maintained less well than in Britain, the factor should be increased by up to 50 per cent. of the value given by this expression. The factor could be reduced if the line is used only for slow-moving traffic (such as mineral trains) or light traffic. An approximate impact factor to allow for hammer-blow from loco-

motives is  $\frac{I}{0.05L + 2}$  for secondary members and for main longitudinal beams not

exceeding 40 ft. in span, and  $0.25 + \frac{L - 40}{450}$  for main beams over 40 ft. span.

The factors for hammer-blow should be reduced for slow-moving locomotives and for lighter locomotives, and increased by one-third for single-track bridges.

These factors are approximate, and are suitable for use only when preparing

preliminary designs; reference should be made to text-books and papers on the subject for accurate analyses. Most published data relating to impact on railway bridges refer to steel bridges, but in the case of reinforced concrete bridges the increased mass of the bridge, the damping effect, and similar relevant factors combine to reduce the seriousness of the dynamic effects.

The effect of lurching is to transfer part of the load from one rail to another of the same track. In the design of any member this effect can be allowed for on main lines by assuming that one rail carries five-eighths of the total live load and the other rail carries three-eighths of the total live load, the most heavily-loaded rail being that which produces the greater stresses in the member being designed. The factors given apply to British conditions, and require adjustments for variations in the span of the member, the speed of the train, the type and rigidity of the structure, and the type of rolling stock in respect to its springing, weight, and height. It is not necessary to allow an impact factor on the transferred load.

**CURVED BRIDGES.**—If a bridge carrying a railway is curved, the centrifugal effect can be calculated from the expression  $F_c = \frac{wv^2}{r} \cdot \frac{n}{15}$ , where  $w$  is the live load on one track expressed as an equivalent uniformly-distributed load in lb.,  $v$  is the speed of the train in miles per hour,  $r$  is the mean radius of the tracks in feet, and  $n$  is the number of tracks. The force  $F_c$ , to which no increase due to impact need be added, is considered as a uniformly-distributed live load acting horizontally at a height of 6 ft. above the level of the rails.

**TRACTIVE EFFORT AND BRAKING.**—The longitudinal forces to which a railway bridge is subject are due to tractive effort and braking, and are based on the maximum shear forces due to live load on the member being designed. The maximum value of the factor by which the maximum shear force should be multiplied is 0.2625 for both the tractive effort and braking force due to steam or electric locomotives, and this value should be increased by one-third for multiple-unit electrical stock. The factors can be reduced for small spans. The forces are considered to act at rail level. Where a bridge carries more than one track, the longitudinal forces need be calculated for only half of the tracks.

**WORKING STRESSES.**—Normally the forces, or the method of calculating the forces, due to centrifugal, lurching, tractive effort, and braking effects, would be specified by the railway owners. If all the secondary effects mentioned, together with wind pressure, are taken into account in the design of a member it is usual to allow, at the discretion of the engineer, an increase in the stresses, but this increase should not exceed 20 per cent. of the permissible working stress. The latter should not be exceeded when the member is analysed for the combined effect of dead load, live load, impact, and lurching. An intermediate degree of increase should be assessed if any of the secondary effects are neglected.

**CORROSION DUE TO GASES.**—The corrosion of the concrete is a factor that must be considered in over-line bridges, and although smoke guards, often in precast reinforced concrete, are commonly provided, they do not entirely protect the structure from deleterious fumes. It is therefore important to provide a dense concrete free from cracks by which the corrosive gases can reach and attack the reinforcement. Thus this aspect becomes a matter of design as well as construction. The amount of cover of concrete over the reinforcement should be

increased beyond that normally provided, and tensile stresses should be limited so that cracks larger than hair cracks are not likely to occur. Deformed bars may be used with advantage to limit the widths of cracks that do occur. In assessing the probability of cracking, the tensile strength of the concrete should be based on tests made to determine the modulus of rupture of the actual concrete it is proposed to use, rather than on an arbitrarily assumed proportion of the compressive strength.

### Culverts and Subways.

It may be necessary to conduct drainage ditches or streams under embankments by means of culverts or to construct subways for pedestrians or cyclists. Frequently such culverts and subways are constructed in reinforced concrete.

**CULVERTS.**—Culverts should be designed to accommodate the flow of water in the stream it is proposed to conduct through the culvert not only under normal conditions but also in times of flood. Records of the flow of the stream at different times of the year, the collation of reliable information on the behaviour of the stream over as long a period as possible, and observation of any existing culverts and bridges over the same stream, may aid in establishing the required data. An allowance should also be made for any interference by the new works of the existing land drainage system which may augment or decrease the quantity of water passing through the culvert.

The culvert should be made in a straight line where possible and to a uniform gradient equal to the mean gradient of the stream between the two ends of the culvert.

The construction of a culvert to conduct a stream more or less along its original course presents difficulties arising from the maintenance of the flow of water. It is usual temporarily to divert the stream so that the culvert can be constructed in the dry. The stream is dammed above the site of the culvert and, from the pond so formed, the water is led through pipes, timber flumes, or open excavated channels on one side of the site and discharging into the original bed below the site.

**PIPE CULVERTS.**—For culverting small streams precast reinforced concrete pipes are suitable, two or more parallel lines being laid when required. Standard pipes are manufactured from 6 in. to 4 ft. internal diameter in increments of 3 in. and may have rebated or socketed ends. The pipes should be bedded on a concrete haunching and, if not surrounded with concrete, should be strong enough to resist, with an adequate margin of safety, the lateral and vertical pressures due to the earth and loads superimposed thereon. It is better, however, for a pipe culvert under a road to be surrounded by at least 6 in. of concrete, reinforced to resist transverse bending stresses if it is on a poor subsoil. This design is suitable for a culvert at a shallow depth, where the traffic load will be high, or at any depth up to, say, 20 ft. where the weight of the earth cover may be high although the effective traffic load may be negligible. The whole construction should also be reinforced to resist any longitudinal bending effects that may occur due to differential settlement arising from unequal loading along the length of the culvert.

The determination of the size of pipe culverts is a problem in hydraulics that has not yet been completely solved. Where the entrance is not submerged the

principles of the flow of water in channels apply, but since the effect of the entrance to the culvert may be equivalent to a large reduction in capacity, especially for short culverts, the net capacity is not accurately determinable. One practical method of design is to provide one or more pipes of sufficient cross-sectional area so that when they are half full the pipes can conduct the normal flow of water. There is then a margin for excessive entrance losses and for an increase in flow above the normal, since when it is half full a pipe has a capacity of a little less than half its maximum capacity. The approximate capacity of a circular concrete pipe of diameter  $D$  ft. flowing half full can be estimated from

$$Q = 15D^2 \sqrt{\frac{DH}{L}}$$

where  $Q$  is the capacity in cubic feet per second,  $H$  is the difference in level between the two ends of the pipe in feet, and  $L$  is the length of the pipe in feet. This expression includes an arbitrary allowance for entrance losses.

The design should then be checked for flood conditions. If the level of the water at the inlet end coincides with the top of the pipe, the capacity of a circular concrete pipe with square corners at the inlet and a flat end-wall at the inlet, the latter not being shaped in any way, is approximately as given in the following table when  $H = 1$  ft. For other values of  $H$ , multiply the tabulated values of  $Q$  by  $\sqrt{H}$ .

| Diameter of culvert $D$ ft | Capacity of culvert $Q$ cu ft per second |     |     |     |
|----------------------------|--|-----|-----|-----|
|                            | Length of culvert $L$ ft                 |     |     |     |
|                            | 30                                       | 100 | 200 | 300 |
| 1                          | 4  | 3   | 2½  | -   |
| 2                          | 18                                       | 16  | 13  | 12  |
| 3                          | 44                                       | 37  | 33  | 30  |
| 4                          | 75                                       | 70  | 64  | 56  |

If a pipe culvert is not suitable for the conditions, it is probable that a box culvert of about the same width and mean gradient as the stream should be provided.

**BOX CULVERTS.**—For a stream that is too large to be dealt with by pipes, a reinforced concrete box culvert with a flat or arched roof and with a slightly dished invert is frequently provided. An arch roof is designed in the same way as an arch bridge. Since the span is usually small, elaborate calculations are unnecessary. It is generally sufficient to calculate the roof as a two-pin arch (the invert forming a tie between the springings) and to provide some reinforcement to resist the bending moments due to fixity at the springings.

A cast-in-situ rectangular culvert is designed as a four-sided rigid frame, the bending moments produced at the corners by various types of loading being as



given in *Fig. 330*. The maximum reverse bending moments on the loaded sides are obtained by algebraically combining the "free" bending moments with those at the corners. For the purpose of *Fig. 330*, all loads are assumed to be acting

|  |                         |   |
|--|-------------------------|---|
|  | $M_A = M_B$ $M_D = M_C$ | $L = A + D_1$ $H = B + D_2$ $k = \frac{H}{L} \cdot \left(\frac{D_2}{D_1}\right)^3$  |
|  |                         | $M_A = -\frac{WL}{12} \left[ \frac{2k + 4.5}{(k + 3)(k + 1)} \right]$ $M_D = \frac{WL}{24} \left[ \frac{k + 6}{(k + 3)(k + 1)} \right]$       |
|  |                         | $M_A = M_D = -\frac{WL}{12(k + 1)}$   |
|  |                         | $M_A = \frac{WL}{6} \left[ \frac{k}{(k + 3)(k + 1)} \right]$ $M_D = -\frac{WL}{6} \left[ \frac{3 + 2k}{(k + 3)(k + 1)} \right]$               |
|  |                         | $M_A = -\frac{WH}{30} \left[ \frac{(2k + 7)k}{(k + 3)(k + 1)} \right]$ $M_D = -\frac{WH}{30} \left[ \frac{(3k + 8)k}{(k + 3)(k + 1)} \right]$ |
|  |                         | $M_A = M_D = -\frac{WHk}{12(k + 1)}$  |

$W$  = Total load (lb per foot width) on one wall, or on roof or invert

**Fig. 330.—Box Culverts.**

inwards; the pressure from the water in the culvert acts outwards, and the bending moments due thereto can be evaluated as for the corresponding inward pressures but with the signs reversed.

The loads acting on the roof are the weight of the earth and the live load on

the road. It is usual to ignore the effect of impact if the culvert has a reasonable cover of earth, and concentrated loads may be so well dispersed by the time they reach the roof that they can be considered as uniformly distributed. If, however, the cover is, say, less than 2 ft. the value of these effects should not be reduced, and, if designed for the Ministry of Transport Equivalent Loading, the 50 per cent. impact factor allowed therein and the knife-edge load should be assumed as fully operative. To allow for the effect resulting from the tendency for the filling on either side of a culvert to settle more than that above the roof, the head of earth over the roof should be assumed to be 15 per cent. in excess of the actual value. The loads on the roof produce bending moments and vertical thrusts on the walls which must be combined with the forces and bending moments due to the weight of the walls and to other causes. Bending moments are also produced due to the lateral pressure of the earth on the walls. In non-cohesive soils these pressures can be calculated by Rankine's formula, and by Bell's formula in cohesive soils such as clays. Some allowance should be made for the probable saturation of the soil against the lower parts of the walls.

The envelopes of the maximum bending moments can be drawn by considering probable combinations of loadings, and the bending moments should be combined with the corresponding thrusts at each critical section when designing the transverse reinforcement. Longitudinal reinforcement is necessary to resist the probable longitudinal bending effects.

The entrance and exit should be protected from scour by continuing the invert for several feet from the culvert itself and providing retaining walls for the same distance.

The construction of a box culvert presents a number of problems relating to the shuttering, one method of erecting the latter in stages being illustrated in *Fig. 331*. The excavation should be taken out to such a slope that timbering is unnecessary. Vertical soldiers are erected as at (*a*) and boarding for the external face of the bottom slab and lower part of the walls is fixed. The invert and bottom slays are now concreted, the external shuttering removed and the boarding for the inner and outer faces of the walls erected as at (*b*). The walls are concreted and shuttering removed. The final stages (*c*) are to erect the roof shuttering, concrete the roof slab, remove the shuttering and back-fill.

**SUBWAYS.**—Subways of rectangular cross-section under roads are designed in a similar manner to that described for box culverts, but in this case as there is little or no earth cover over the roof of the subway the principal loading will be that due to traffic. The Ministry of Transport recommends that pedestrian subways should have a minimum headroom of 7 ft. and a clear width of 7 ft. 6 in. The corresponding dimensions for subways for cyclists are 7 ft. 6 in. and 10 ft. 6 in. for traffic in one direction or 15 ft. 6 in. for traffic in both directions. Subways for pedestrians and cyclists should have a footpath 6 ft. 6 in. wide raised above the cycle track, and should have the foregoing headrooms and widths for the cycle track.

### Precast Concrete Bridges.

For the construction of bridges over railways and canals and in other positions where the need to maintain traffic makes impossible the erection of temporary falsework and limits the available working periods, precast concrete can be used

with advantage. The principle of this type of construction is that precast reinforced concrete beams, which can be made adjacent to the site or at a concrete works, are placed in position on the piers and abutments that have been previously constructed, usually in situ. There are two principal methods, namely, (i) the beams are spaced apart and the deck slab is cast in situ thereon, and (ii) the beams are laid closely together to form the deck.

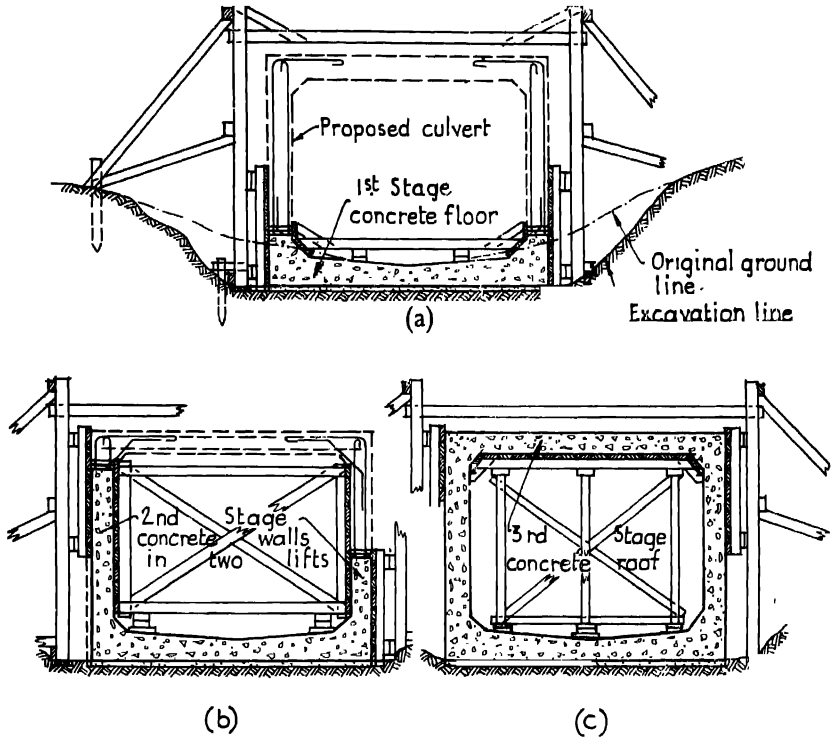

Fig. 331.—Shuttering for Box Culverts.

An example of the former method is illustrated in Fig. 332. The beam forms the web of a T-beam, the flange of which is formed by the cast-in-situ slab. Binders project above the concrete and are bonded into the slab and, if the beam is to form one span of a series of continuous spans, reinforcement projects from the ends to connect with the adjacent beams. The reinforcement is designed for the ultimate condition of a T-beam subject to the full dead and live loading, but the stresses in the beam must also be checked to ensure that during transport and erection the concrete is not overstressed in compression and that reinforcement is provided in the top to resist tensions due to reverse bending moments. The stresses in the beam due to its own weight when in its final position and the weight of the shuttering and the wet concrete forming the deck slab and any

incidental loads thereon, must also be examined. Since the stresses during handling are due to the dead weight of the beam, it is essential not to underestimate this weight. It will usually be well in excess of the generally-accepted value of 144 lb. per cubic foot. If possible the actual weight due to the gross weight of the reinforcement and the weight of the concrete (as determined from test cubes) should be calculated.

**STRESSES DURING LIFTING.**—The stresses during erection can be controlled by selecting a suitable method of hoisting. For short beams lifting at the central point may be permissible, but in this condition the beam is a double cantilever and must be designed as such. For beams of medium length suspension at the two ends from a single crane hook is practicable, in which case the temporary bending moments are in the same sense as the permanent moments. Beams exceeding 20 ft long are preferably suspended at two intermediate points. In

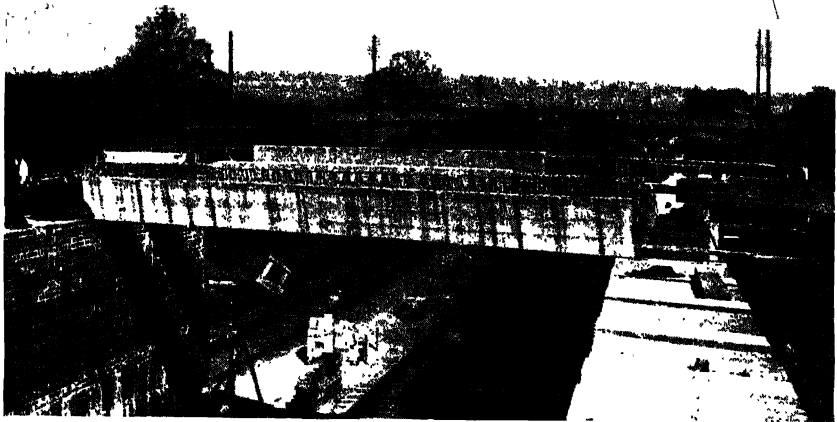

Fig. 332.—Erecting a Precast Concrete Bridge.

this case a steel spreader or strong-back is suspended from a crane and the beam is suspended on a link at each end of the former. The positions of the two points of suspension can be determined so that the temporary bending moments during lifting are adjusted to suit the strength of the beam. Generally the positions would be such that the safe moment of resistance based on the compression at the midspan section of the beam would equal the safe moment of resistance based on the tension due to cantilever action at the points of suspension.

There are several methods of attaching the suspension member. If care is taken to protect the concrete from damage, a chain sling wrapped around the beam may suffice for single-point lifting, but where it is necessary to lift the beam at predetermined points a suspension eye can be cast into the top of the beam, or horizontal holes can be formed through the beam when it is cast.

**ARCH RIBS.**—Precast units may not always be beams since, up to 30-ft. span, single arched members have been used. For greater spans, two semi-arch units that when combined form a three-pin arch have been successful.

**IN-SITU DECK.**—If the deck slab is not also made of precast units, it is necessary to erect shuttering to support the concrete. This is done by bolting timber bearers to each side of the precast beams after erection, bolt holes being formed in the beams during casting. These bearers support transverse timber joists spanning in the same direction as the beam, and the joists in turn carry the timber or steel sheeting. Such a construction for the shuttering is possible without any projection below the soffit of the beam.

When the deck consists of precast beams laid in contact with each other to give a continuous deck, a method of interlocking must be adopted to distribute the live load over a number of units and prevent any beam deflecting more than its neighbours. This can be done by constructing a thin cast-in-situ reinforced concrete slab on top of the beams, and if provision is made for the precast beams and in-situ topping to bond effectively the combined construction can be considered as a single structural unit and continuity may be imparted thereto. This results in the precast unit being lighter than would otherwise be necessary. The beams may either be rectangular or preferably of I-section, U-section, or inverted U-section. The necessary bond between the precast and cast-in-situ portions of the construction is effected by the projection of reinforcement from the former and by the roughening of those surfaces of the precast beam that will be in contact with the cast-in-situ concrete.

**FOOTBRIDGES.**—Footbridges over railways and the stairs in conjunction therewith are frequently constructed of precast reinforced concrete. The usual form is a pair of parapet girders, the footpath being composed of precast slabs spanning between the girders. Precast double-cantilever frames are sometimes bolted to the girders to prevent buckling of the top flanges. The supporting trestles are also made in precast units. The units for this type of bridge, which may have spans up to 50 ft., are usually constructed at the concrete dépôt of the railway concerned, which may be many miles from the site. The erection necessitates the occupation of the line for a few hours only.

Another form of footbridge over a railway, and one which has been used for spans exceeding 55 ft., incorporates a single precast reinforced concrete girder of T-section, the top flange of the T forming the footpath.

### **Jacking Arches.**

The inducement of predetermined bending moments and thrusts by controlled distortion by jacking open the crown of an arch during construction is analogous to prestressing. The stresses in an arch are primarily due to the dead and live loading, and in large spans the stresses due to shrinkage, contraction of the concrete under compression, temperature changes, and settlement upon removal of the temporary centering are of much importance. The effects of shrinkage, arch contraction, and settlement of staging are all of the same nature insofar as they produce negative bending moments at the springing and positive bending moments at the crown, so that if bending moments of the reverse sense are induced in the arch the effects mentioned can be neutralised. These induced bending moments are produced by leaving a temporary gap at the crown, opening this gap by jacking, and thereby raising the arch at the crown. Consequently a positive bending moment is produced at the springing. The negative bending moment at the crown is produced by placing the jack eccentrically about the

centre of the crown section, the amount of the eccentricity depending upon the magnitude of the moment desired. Since there is a gap at the crown across which there is no reinforcement, this method is only possible where no tensile stresses are produced under any combination of loading and other forces.

This method of jacking arches, which serves the same purpose as temporary hinges, was devised by M. Freyssinet and used for a number of bridges on the Continent. The first instance of its use in Britain was in the construction of a bridge over the River Thames at Chiswick.

The gap, or plane of separation, at the crown is provided transversely across the entire width of the bridge, and recesses are left in the concrete to receive the jacks (*Fig. 333*). The portions adjacent to the recesses are heavily reinforced to distribute the thrust from the jacks, and the concrete near the crown, which is

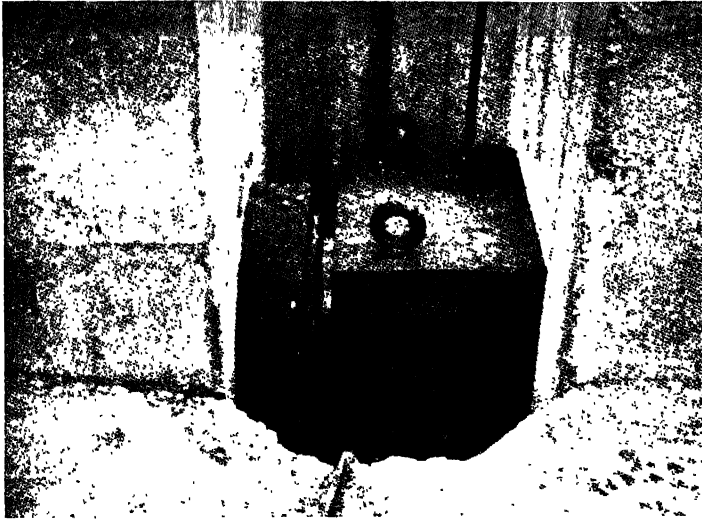

**Fig. 333.**—Jack in Recess at Crown of Arch.

highly stressed at an early period, is placed before that in other parts of the arch so that it has time to mature. These preliminary sections are placed for the full width of the bridge and, in the case of Chiswick bridge, were approximately 26 ft. in length. Between the recesses for the jacks the face of the concrete on either side of the plane of separation is temporarily lined with mild-steel plates  $\frac{3}{16}$  in. thick. As the construction of the arch proceeds, a record is kept of the deflections of the centering and the arch itself, since these data are required when computing the amount of the opening of the arches at the crown and the required eccentricity of the jacks. With the deductions made from these measured deflections, the estimated effect of future shrinkage and arch shortening due to compression under dead and live load is combined.

For Chiswick bridge, ten hydraulic jacks of a working capacity of 250 tons

each were provided at the crown of each span. Two interconnected pumps operated the whole of the ten jacks simultaneously. Pressure gauges were provided at each pump, at each external jack, and one centrally. The procedure was to increase the load exerted by each jack in increments of 20 tons up to 180 tons, which was estimated as being about 90 per cent. of the total force required. The time taken to reach this load was 35 minutes, pumping being stopped at frequent intervals for measurements to be taken. At this stage the maximum vertical rise in the level of the crown of the arch was 0.64 in. and the horizontal opening was 0.5 in. The pressure was then reduced to zero in four stages and the arch resumed its original position.

The pressure was then increased in stages as before but up to a maximum of 220 tons on each jack when the vertical rise reached the required value of 1.25 in., for which the horizontal opening was 1 in. The rotation of the intermediate piers was also measured, and under maximum thrust the horizontal displacement of the piers at springing level was approximately 0.18 in. The pressure of 220 tons was maintained for 45 minutes while the gap in the arch was prepared for filling. The steel plates were withdrawn and the bottom of the gap was plugged with rope, the open ends being closed with timber shuttering. A hand-mixed mortar, composed of  $2\frac{1}{2}$  parts of uncrushed sand having uniform grains  $\frac{3}{16}$  in. in diameter to 1 part of ordinary Portland cement and with a water content equivalent to 1.25 gallons to 1 cu. ft. of dry sand, was deposited in the gaps in layers of about 2 in. The mixture was very dry, thereby being practically incompressible but sufficiently workable to be placed in the narrow gaps and consolidated by vigorous punning with flat iron bars. This operation occupied about 12 minutes, and previous tests had shown that such a mortar could resist very high compression immediately after deposition. Upon completion of the consolidation the pressure on each jack was reduced from 220 tons to 180 tons. This relaxation caused the gaps to close about 0.001 in. due to compression of the mortar, but during further reduction of the pressure of the jacks to zero no further closure took place. The crown of the arch continued to rise, however, by about 0.1 in. but this had disappeared in about two hours. The entire operation of jacking the arches took about three hours. After removal of the jacks from the recesses, the sides of the latter were thoroughly hacked and cleaned, and the recesses were filled solid with concrete, which was kept damp during hardening to prevent shrinkage.

### Temporary Hinges.

An earlier method, and one more frequently used than jacking, for controlling the bending moments on arches is the provision of hinges. Since a hinge can only transmit thrusts, pulls, and shear forces, the bending moment at a hinge is zero. Thus at a section at which it is desired to relieve temporarily the bending stresses, a temporary hinge can be provided. Thus if during construction temporary hinges are introduced at the crown and springings of the arch, the latter becomes a three-pin arch and will adapt itself to shortening due to shrinkage, to contraction, to the effects of the settlement of the centering, to unequal settlement of the piers or abutments, and to the dead load of the arch itself. Thus it can be arranged that these combined effects do not produce bending moments at the critical sections at the crown and springing.

The simplest form of temporary hinge (due to M. Considère) is merely a reduction in the area of the concrete at the crown (*Fig. 334*). The amount of concrete must be sufficient to transmit the thrust and shear to which the crown section will be subject during the time it is acting as a hinge. In order to make the section as flexible as possible the amount of concrete should be as small as possible, and to increase its compressive resistance it is usual to provide helical binding around some longitudinal bars. The main reinforcement of the arch, which will be subject to stress when the hinge no longer operates, passes through the gap above and below the reduced section. Shear reinforcement in the form of binders, which may be required especially in an arch rib, will also necessarily be in position during the time the crown section is acting as a hinge. It is held, however, that the reinforcement passing through the gap does not offer serious resistance to the rotational action of the hinge since, owing to the preponderance of the direct thrust, the main reinforcement is in compression during the temporary hinge action.

The gap above and below is filled with well-compacted concrete when hinge action is no longer required and the section is able to resist bending moments as elsewhere in the arch. The bending moments may be due to the combined effects of the subsequently applied dead load, the live load, additional contraction due to these loads, subsequent shrinkage (which is very small since the greater part of the shrinkage will have taken place while the temporary hinge operated), and change of temperature. These bending moments, except those due to change of temperature, can in part be offset by inducing bending moments of equal magnitude but of opposite sense on the arch. In the case of the springing of the arch,

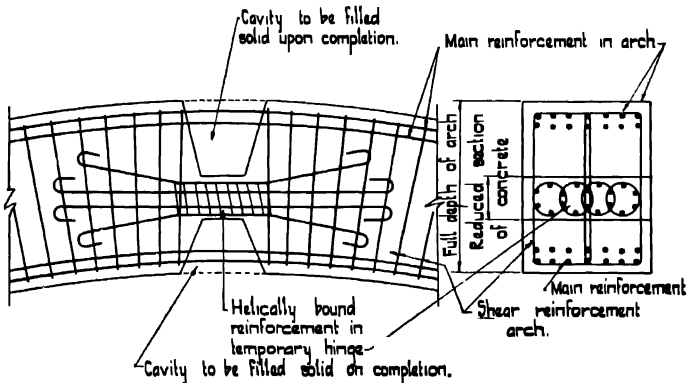

Fig. 334.—Elevation and Section of Temporary Hinge at Crown of Arch Rib.

where the bending moments due to loading and other effects are negative, the counteraction can be induced by arranging the hinge eccentrically above the centre of the section. At the crown the hinge would be eccentrically below the centre of the section.

### Permanent Hinges, Bearings, and Joints.

Permanent hinges are required in a bridge to ensure that thrusts and shear forces can be transmitted and rotation permitted without restraint at the assumed



points of zero bending moment. Such conditions occur in two-pin and three-pin arches and in portal-frame bridges where the connection between the bases of the verticals and the foundations is assumed to be a pin joint.

Fig. 119 shows a detail of a permanent hinge in a small portal-frame bridge. Fig. 335 (a) gives an enlarged detail of a similar hinge, while at (b) is an alternative

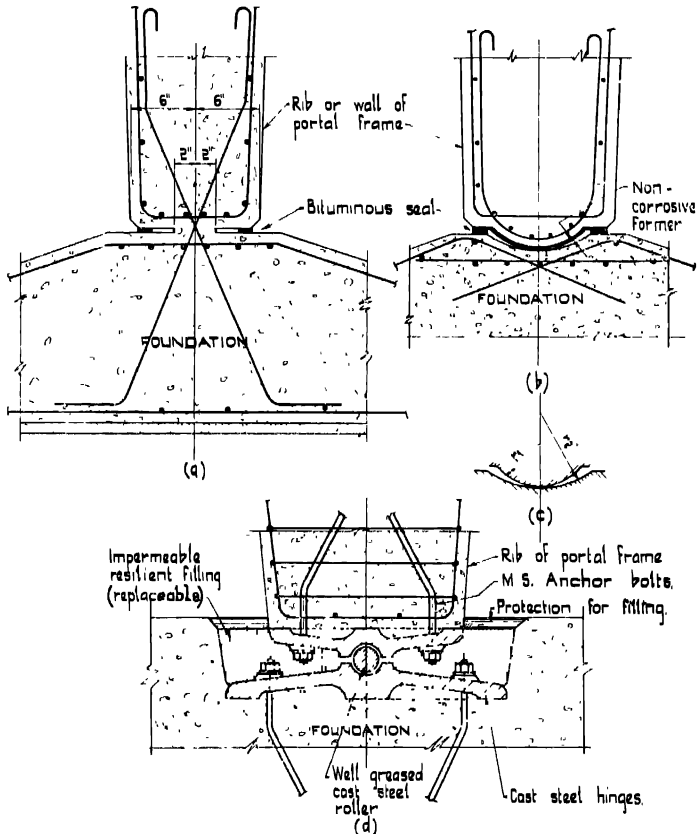

Fig. 335.—Hinges for Portal Frames.

design. In (a) the reduced section of the concrete should be sufficient to transmit the vertical thrust to the foundations without exceeding the permissible compressive stress. It is also essential for this concrete to be able to transmit the horizontal thrust without exceeding the permissible shear stress in the concrete without shear reinforcement. The effective area resisting the shear stress should not be assumed as greater than seven-eighths of the gross area.

If reasonable dimensions for the reduced section are not obtainable within these limitations, a design similar to that at (b) should be adopted. In either design the concrete immediately adjacent to the hinge should be well reinforced

to resist the secondary stresses that are induced but which cannot be calculated. The maximum reaction  $R$  lb. that can be transmitted by a concrete bearing of design (b) and width  $B$  in. is given by  $R = \frac{5.6c^2 B r_1 r_2}{\bar{E}(r_2 - r_1)}$ . In this formula, which is based on Hertz's formula (Chapter VIII) and which is not applicable if  $r_1$  is nearly equal to  $r_2$ ,  $R$  is the maximum reaction (not necessarily vertical) obtained by the vectorial addition of the various combinations of the horizontal and vertical thrusts, and  $r_1$  and  $r_2$  are the radii of the two faces of the bearing as shown in *Fig. 335 (c)*. The shaped foot at the base of the vertical member of the frame is difficult to construct unless the member is precast. Therefore a thin non-corrosive former should be used and left permanently in position. Alternatively the difference in radii can be formed in plaster.

If sufficient resistance cannot be obtained by a concrete hinge of design (b), a steel hinge of similar design to that shown in *Fig. 335 (d)* should be used. This design, as is that at (b), is most suitable for slab and girder bridges in which the girders and counterforts of the abutments form a portal frame. Owing to the continuous nature of the bearing in slab bridges of portal-frame design, this type of bridge would never require hinges of the design shown at (d), and rarely would necessitate adoption of the design (b).

Some designs for hinges for arch bridges have been illustrated in previous chapters. Attention is drawn to *Fig. 145* where details are given for the crown and springing hinges of a three-hinged arch-slab bridge, earth filled and with solid spandrels. The hinges form a complete plane of separation through the slab, and the joints are carried up through the spandrel walls. The hinge is protected from the earth filling by the provision of loosely-fitting cast-iron plates.

Other designs for crown and springing hinges are given in *Fig. 232* for a three-hinged cellular arch bridge. Details of similar semi-circular concrete springing hinges are given in *Fig. 179* and *Fig. 180*. In an arched rib bridge, the forces on the hinges are concentrated on the comparatively narrow width of the rib. In bridges of large span, a concrete-to-concrete hinge may not offer sufficient resistance and therefore a cast-steel hinge may be necessary.

The provision of expansion joints and articulations in girder bridges necessitates the provision of joints and bearings, the details of which must be given considerable attention if the resulting design is to act as intended. Bearings may be either of a type that permits rotation but not lateral movement (termed a "fixed bearing," although offering no resistance to bending moments as does the "fixed" end of the beam), or of a type that permits both rotation and lateral movement (termed a sliding bearing).

Any of the designs of hinges in *Fig. 335* are in effect "fixed" bearings and can be adapted for use in girder bridges. A simple alternative is illustrated in *Figs. 186* and *187* where a convex form to the top of certain lengths of the abutment registers with a concave face of larger radius on the underside of the girder at the bearing. A similar design is used at the "fixed" bearings of the bridges illustrated in *Figs. 167* and *173*, but for the piers of the latter bridge where lateral movement is to be permitted a "rocker" bearing continuous along the full width of the pier is provided. The rocker is a heavily-reinforced precast concrete block with convex upper and lower ends which fit into concave recesses on the underside of the girder and the top of the pier. If the stress in the concrete is

excessive, cast-iron rockers of similar shape can be used, in which case flat steel plates are built into the underside of the girder and into the top of the pier or abutment, and against these plates the rocker bears. The vertical load in pounds transmitted by a cast-iron rocker should not exceed the distance in inches between the convex faces multiplied by the length in inches of the rocker multiplied by 300, and the compressive stress should not exceed 9000 lb. per square inch. The permissible pressures on various materials for other types of girder bearings are given in Chapter IV.

Another type of cast-iron rocker bearing suitable for heavy loads is shown in Fig 336. For exceptionally heavy loads, cast steel may be used and a central supporting web may be added. The vertical load in pounds should not exceed the radius  $m$  inches times the length in inches multiplied by 600 for cast iron and by 1200 for cast steel, that is  $W = R \times l \times 600$  for cast iron and  $W = R \times l \times 1200$  for cast steel

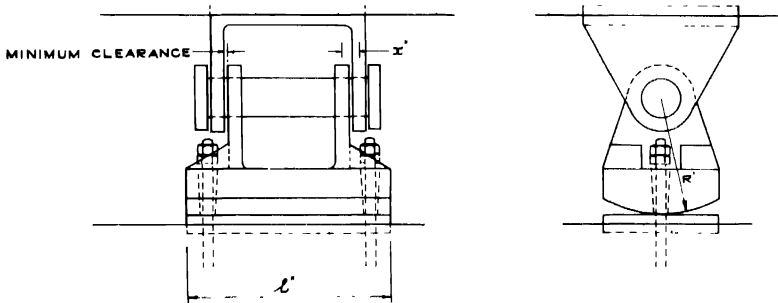

Fig. 336.—Rocker Bearing.

The steel pin must be designed for bending, shear, and bearing, the maximum permissible stresses being 27,000 lb. per square inch, 13,500 lb. per square inch, and 27,000 lb. per square inch respectively. The bending moment is the load on one leg multiplied by the maximum distance between the centres of two adjacent legs, that is  $M = \frac{W}{2} x$  in., Fig. 336.

EXAMPLE.—Design a rocker bearing for a load of 150,000 lb. If  $R = 12$  in. then  $l = \frac{150,000}{600 \times 12} = 20.8$  in., say, 21 in.

With a bearing plate 12 in. wide the compressive stress in the concrete is  $\frac{150,000}{21 \times 12} = 595$  lb. per square inch.

If  $x = 2$  in., the bending moment in the steel pin is  $75,000 \times 2 = 150,000$  in. lb.

The section modulus  $z$  is  $\frac{\pi d^3}{32}$ ; therefore  $d = \sqrt[3]{\frac{150,000 \times 32}{\pi \times 27,000}} = 3.84$ , say, 4 in. Therefore the stress due to bending is  $\frac{150,000 \times 32}{\pi \times 4^3} = 23,800$  lb. per square inch.

If the thickness of the legs is  $1\frac{1}{2}$  in. then the bearing stress is  $\frac{75,000}{4 \times 1\frac{1}{2}} = 12,500$  lb. per square inch, and the shearing stress is  $\frac{75,000}{\pi \times 2^2} = 6000$  lb. per square inch.

The bearing plate will be of cast steel, planed on the upper surface and with a minimum thickness of 1 in.

The bending moment on the plate is  $75,000 \times 3 = 225,000$  in. lb.

$$Z = \frac{21d^2}{6}; \text{ therefore } d = \sqrt{\frac{6 \times 225,000}{18,000 \times 21}} = 1.88, \text{ say, } 2 \text{ in.}$$

A simple sliding bearing, consisting of two steel bearing plates, is illustrated in *Fig. 67*. This type is suitable for small spans only owing to the frictional resistance offered by the plates, a rocker bearing being more suitable for large spans or other conditions producing heavy forces.

For suspended girder spans a checked form of bearing is required to transmit the load from the free beam to the cantilevers. This may be a simple halved joint as in *Fig. 171* and *Fig. 184*. With heavier loads a more complex stepped joint as in *Fig. 167* is required. In the latter design, at each step an upper and lower bronze plate are connected to the concrete with two bronze bolts of 1 in. diameter. The stepped joint occurs for the width of the girder only; between the girders the joint is a plain gap formed with a cork slab 1 in. thick.

An expansion joint in a bridge, as in other structures, must be carried right through the work to effect complete separation. In girders, provision for expansion and contraction is made by sliding bearings, stepped bearings, or other devices introduced for the purpose of making the structure statically determinate. The joint must, however, be carried through the deck slab and wing walls. An

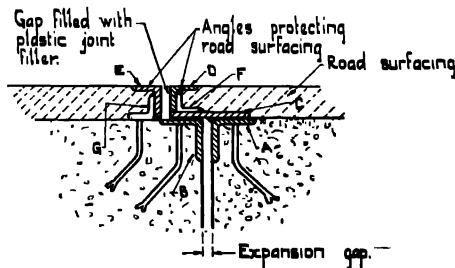

**Fig. 337.**—Expansion Joint in Deck Slab.

example of the latter is given in *Fig. 161*. The bent copper strip shown in section FF crosses the joint and thus prevents the extrusion of the earth filling or the intrusion of the weather without affecting the flexibility of the joint.

A typical design for an expansion joint in a bridge deck slab is shown in *Fig. 337*. The continuous angles A and B are secured to the concrete of the deck slab on either side of the expansion gap by means of lugs or anchor bolts. A steel plate C is welded or riveted to angle A but is free to slide on angle B. If a corresponding gap is not made in the road surfacing, cracks will occur in the latter. The edges of the gap must, however, be protected, and one way of so

doing is to provide continuous angles D and E. Angle D is secured by welding or riveting to the cleats F which in turn are secured to the sliding plate. Angle E is secured to the cleats G which are bolted into the concrete slab. To prevent stones or other matter clogging the gap and preventing free movement, the latter should be filled with a plastic joint filler.

### **Drainage and Waterproofing.**

In bridges of small spans the question of drainage is not serious since the provision of a camber or cross fall to the road surface and a cross fall to the pavement will cause rainwater to flow towards the kerb channels and thence, by virtue of the longitudinal fall or longitudinal camber of the bridge, to road drainage systems at either end of the structure. In long bridges provision has to be made to collect rainwater at intermediate points, usually over piers, and to conduct it to places where it can be disposed of conveniently. The provision of openings through which the water falls freely on to whatever is below the bridge is seldom permissible except in the case of a bridge crossing water where water-borne traffic is negligible. In all cases, however, it is essential that the water should be discharged free of the structure, otherwise stains will be produced on the surface.

For bridges over roads, footpaths, railways, and frequented rivers, the rainwater should be collected at each pier and abutment and conducted to the foot of the pier where it can be discharged into the drainage system beneath, or directly into the river, as the case may be. For appearance sake the pipes should be concealed, but they should not be so arranged that leaks cannot be detected and easily repaired.

Where the road surface is of bituminous or asphaltic material it may be impervious to such an extent that all rainwater falling upon it finds its way to the drainage system. If the surfacing is not impervious, as in the case of ballasted railway tracks, the concrete deck slab should be sloped towards transverse and longitudinal channels formed in the slab so that the water is conducted to the drainage system. Although the concrete may be practically impervious to water passing over it, waterproofing measures, such as asphaltting, should be taken in all parts of the work where water in large quantities can collect, due either to the presence of pockets in the work or to discharge pipes being accidentally clogged. Generally the place most susceptible to such collections is behind the springings of earth-filled solid-spandrel bridges, and in cellular abutments. Normally the design would provide for such positions to be adequately drained.

### **Wind Pressure.**

It is difficult to assess the effects of wind on bridges, and the rules relating to buildings are of little value. In a normal reinforced concrete bridge of small or medium span erected at the same level as the surrounding ground and of a width about equal to the height, forces due to the pressures and suctions of the wind can be neglected as the stresses induced thereby are small compared with those due to dead and live loading. For high bridges or for bridges erected in exposed positions the stresses due to wind should be investigated, although for road bridges under conditions of dead load plus live load (including impact) plus the effect of temperature, shrinkage, and arch contraction plus wind pressure, it is probably acceptable to increase the allowable stresses by one-third (as in buildings) above

the stress permissible for all these effects except wind pressure. In the design of reinforced concrete bridges the increase in stress due to wind pressure, and longitudinal centrifugal forces, might be limited to 20 per cent. of the permissible stresses due to dead load plus live load (including impact and lurching) plus the effects of temperature, shrinkage, and arch contraction.

The effect of wind varies with the situation of the structure, the degree of shelter afforded by the environment (buildings, hills, etc.), the height above the general level of the surrounding terrain, the rigidity of the structure, and the shape of the members. The presence of vehicles or trains on a bridge increases the area of resistance to wind.

The magnitude of the pressures and suction resulting from wind on a structure depends on the velocity of the wind and the shape of the member exposed. The velocity in turn depends on the district and the height. In Britain the velocity of gusts of wind rarely exceeds 100 miles per hour, and such gusts are limited to the western coasts. Gusts of upwards of 80 miles an hour are, however, fairly widely, although infrequently, experienced in exposed positions. Thus for practical design, and in the absence of any local meteorological observations, the maximum velocities near ground level might be assumed as 85 miles an hour in Wales and in the West of England and Scotland, 75 miles an hour in the east and south of England and the east of Scotland, and 70 miles an hour in the central parts of England. These velocities are applicable to sites near the coast and on high ground inland, and may even require to be increased if conditions of extreme seaward exposure obtain. For inland sites in open flat or undulating country velocities equal to 85 per cent. of the foregoing can be assumed, and 75 per cent. of the maximum velocities where the bridge is sheltered from full exposure by surrounding hills. These velocities would be applicable to structures extending not more than 40 ft. above the general ground level. A formula given by the Meteorological Office for the variation of wind velocity ( $V$  m.p.h.) with height ( $h$  ft.) can be transformed into the expression

$$V = K[1 + 2.81 \log (0.305h + 4.75)]$$

where  $K$  is a constant that can be evaluated if the velocity is known at a given height. For the conversion of wind velocity in miles per hour into pressure ( $p$  lb. per square foot) on large flat surfaces the expression  $p = 0.0034V^2$  can be adopted. A comprehensive formula, which is given in the British Standard Code for "Loading," gives the relation between pressure, wind velocity at 40 ft., and height as

$$p = \frac{V}{600} \sqrt{1 + 0.06h}$$

It is assumed that there is no increase in pressure at heights above 200 ft.

The following numerical examples indicate the method of assessing the basic pressure  $p$ .

(i) Assuming a maximum wind velocity of 85 miles per hour at 40 ft. above ground level, determine the pressure on a flat surface 100 ft. above ground level for conditions of maximum exposure.

$$\begin{aligned} (a) \text{ From } \quad V &= K[1 + 2.81 \log (0.305h + 4.75)] \\ 85 &= K[1 + 2.81 \log (12.2 + 4.75)]. \end{aligned}$$

Therefore  $K = 19.05$ .

Thus at 100 ft.,  $V = 19.05[1 + 2.81 \log(30.5 + 4.75)] = 102$  m.p.h.

Therefore  $p = 0.0034 \times 102^2 = 35$  lb. per square foot.

$$(b) \text{ From } p = \frac{V^2}{600} \sqrt{1 + 0.06h}, \quad p = \frac{85^2}{600} \sqrt{1 + 6} = 32 \text{ lb. per square foot.}$$

(ii) For what maximum wind pressure should a bridge in an inland district and sheltered from full exposure be designed? Assume the parapet of the bridge is 20 ft. above the general ground level.

The appropriate maximum velocity is 75 per cent. of 70 miles per hour at 40 ft., that is,  $52\frac{1}{2}$  miles per hour.

$$(a) \quad 52.5 = K[1 + 2.81 \log(12.2 + 4.75)].$$

Therefore  $K = 11.75$ .

$$V = 11.75[1 + 2.81 \log(6.1 + 4.75)] = 46 \text{ m.p.h.}$$

Thus  $p = 0.0034 \times 46^2 = 7.2$  lb. per square foot.

$$(b) \quad p = \frac{52.5^2}{600} \sqrt{1 + 1.2} = 6.8 \text{ lb per square foot.}$$

When contrary pressures are not specified, it is usual to consider that an unloaded bridge is subject to wind pressure of 50 lb. per square foot, a loaded road bridge to 20 lb. per square foot, and a loaded railway bridge to 30 lb. per square foot.

The effect of wind on a bridge or any other structure has not yet been fully investigated, and the assumption of a uniform pressure on the windward side is merely a conventional manner of allowing something for the complex distribution of positive and negative pressures that occur on the surfaces of the various members.

The pressure on a surface which is not flat is less if the surface is convex and greater if concave. Concave surfaces of great extent are not common in bridge design. The wind pressures on members presenting a surface other than a flat one normal to the wind can be reduced by 40 per cent. if cylindrical and by 20 per cent. for other shapes, although for a square section on which the wind blows normal to a diagonal a reduction of one-third can be made.

The area of a bridge assumed to be exposed to the wind is normally the area of the windward elevation, although some allowance should be made for the leeward parapets and girders. When the bridge is an open-spandrel or similar openwork design, the pressure on the exposed leeward area (that is, the net area of the leeward girders, arches, or parapets facing windward) should be included, but some reduction in the area so included can be made if the distance between the windward and leeward areas is less than twice the depth of the members concerned. Alternative assessments of wind loading should be made for the unloaded and the loaded bridge. In the latter case, allowance can be made for the leeward parts screened by the load, but the area of the latter extending above the parapets, or having the effect of converting open-parapets or girders into solid members, must be included in the windward exposed area.

It is seldom necessary to design each secondary member of a reinforced concrete bridge for wind stresses, but the principal members and the bridge as a whole should be analysed for wind effects, bracing (as in bowstring construction)

being provided where necessary. Considerable stresses can be induced in light members due to vibrations caused by the periodicity of wind gusts, but again it is unusual for reinforced concrete members to be susceptible to this phenomenon.

### **Testing and Maintenance.**

Where bridges are required to be tested, the test load should not be applied until all parts of the structure affected have attained the design strength. It is not usual for the test load on a bridge to exceed by a specified amount the design load, as in buildings, but it is rarely possible for the test load to be exactly the same as the specified design load owing to the difficulty of obtaining sufficient vehicles of the prescribed weights. It is necessary, therefore, to determine what vehicles (or locomotives in the case of railway bridges) will be available for the test and to dispose these in one or more arrangements so that the maximum bending moments, thrusts, and shear forces due to the design load are produced at the critical sections. Thus, although the design load for a road bridge may be a uniform load combined with a knife-edge load, it may be necessary to simulate the effects of this loading by means of several steam rollers, traction engines drawing heavy loads on trailers, loaded steam wagons, etc. In some tests, a deep layer of sand spread over the roadway and the footpaths has been combined with moving vehicles to correspond to the design load, but in the case of a large bridge the cost of clearing away the sand would usually make the test more expensive than hiring heavy vehicles for the purpose.

If a specified vehicular or locomotive load is subject to impact, it is necessary to reproduce this effect to some extent in the test. In some cases an artificial impact has been produced by lorries passing over a plank laid on the deck.

During the test, apart from close inspection for the occurrence of cracks (a record of the sequence in which cracks appear is as important as records of the final cracks), deflections at midspan should be measured during various stages of the test and any residual deformation after the removal of the load should be determined.

During the life of a bridge a regular inspection and recording service should be instituted either by the authority owning the bridge or by the designing engineers on behalf of the authority. Among the matters which should be the object of routine inspections is the operation of the drainage system, expansion joints, hinges, and sliding bearings. If slight cracks are detected, either in the road surface or elsewhere, these should be kept under observation, and by means of "tell-tales" or otherwise, their development should be watched until the cause is ascertained and the defect made good. Settlement of foundations and scour at river piers should be watched for, and examination should be made for deterioration of surfaces. All such records should be allied to a corresponding record of weather cycles.

### **Plain Concrete Bridges.**

Concrete bridges without reinforcement are now seldom constructed, although in the past plain in-situ concrete arches were common. Many plain concrete viaducts were built with a facing of brick, their true structure being hidden.

Plain concrete arches are sometimes built with precast concrete blocks, in the same manner as are masonry arches, with concrete haunching on the



arch ring. Several solid-spandrel concrete viaducts of this type consisting of arches of about 30-ft. span have been constructed in connection with railway extensions near London, and plain concrete blocks have elsewhere replaced masonry for the construction of open-spandrel arches. In-situ plain concrete arches are often suitable for small culverts. An outstanding example of a cast in-situ plain concrete bridge is that built at Wansford in 1928. This has two side spans of 50 ft. and a middle span of 110 ft.

As plain concrete can resist practically no tensile stress, it is not suitable for beams or slabs. Arches of plain concrete must be designed so that the concrete is always in compression, which condition is assured as regards stresses due to the primary structural action if the line of thrust under any condition of loading remains within the middle third of the thickness of the arch ring. Such arches are therefore designed in the same way as are masonry arches, as described in most text books on the theory of simple structures. Arches without reinforcement can be provided with two or three hinges depending upon the same conditions as described for reinforced concrete arches in Chapter VII. Plain concrete arches are only practicable when the ratio of rise to span is more than about 1 to 7; the arch ring is much thicker than a corresponding arch in reinforced concrete. In some circumstances a plain concrete arch may be economical, one obvious circumstance being when steel is very dear or unobtainable.

Although the statical calculations may show the absence of tensile stresses in an arch, such stresses may be induced due to the shrinking of the concrete on maturing, or to thermal contraction. Stresses due to restrained shrinking can be kept small by casting an arch ring in short pieces with gaps between and filling the gaps subsequently. The use of precast concrete blocks obviates almost the whole of the stresses due to shrinking, but construction in alternate segments or methods producing similar results must be used in the construction of plain in-situ concrete retaining walls, piers, and abutments.

The prevention of stresses due to restrained thermal contraction is less simple, but aids in this direction include casting the concrete when the temperature is not high (but not so low as to cause trouble from freezing), and the provision of permanent hinges in the arch ring. Undesirable stresses due to temperature may also occur because of the heat generated during the setting of the cement being unable to escape from the mass of the concrete. This condition, which is likely to occur in massive plain concrete abutments or the foundations of piers, can be in part obviated by using a low-heat cement, by providing artificial means of cooling the concrete, or by placing the concrete in small quantities at long intervals of time.

The methods described in Chapter VIII for the design of massive plain concrete abutments for arches are applicable whether the arch is of plain or reinforced concrete.

## APPENDIX I

### CONDITIONS OF CONTRACT

In the following is given (by permission) the General Conditions of Contract issued jointly by the Institution of Civil Engineers and the Federation of Civil Engineering Contractors in 1955. These conditions are suitable for use in connection with civil engineering contracts such as bridge construction.

It is imperative that the engineer, when using standard conditions, should examine the circumstances of each contract to ensure that the requirements of every clause are in accordance with his intentions. Where any clause is contrary to the latter the wording should be altered and the remaining clauses should be scrutinised to detect inconsistencies arising from the modification. It is desirable to indicate to the contractor any variations that have been made from standard conditions, otherwise the contractor may overlook important differences and thereby cause trouble for himself or the engineer during the progress of the work.

There are in most standard conditions a number of optional clauses, and these should be studied particularly and the selected clause clearly indicated, either in the clause itself, or in an addenda to the Conditions of Contract, or preferably on the Form of Tender. In the conditions given in this Appendix, the following clauses require the exercise of the engineer's option:

Clause 10.—State the amount of the bond, if any.

Clause 23.—State the amount of the third-party insurance.

Clause 43.—The time for completion of the works should generally be stated by the contractor when submitting his tender.

Clause 47.—State the amount of liquidated damages, if any.

Clause 49.—State the length of the maintenance period. This may be six months or one year for a bridge contract.

Clause 60 (i).—The percentage and limit of the retention money should be stated together with the minimum amount of an interim certificate. The percentage is usually 10 per cent., but the other sums depend upon the value of the contract.

Clause 60 (ii).—The period within which payment is to be made after a certificate has been issued should be stated. Fourteen days is a convenient period.

There will generally be a number of special conditions relating to a particular contract. These can be inserted at the end of the general conditions or in the preamble to the specification. In the following typical documents the latter course has been adopted.

The Ministry of Transport has standard Conditions of Contract which, however, have been varied considerably during the past twenty years. The last edition was published in 1947 under the title "Standard Forms, Conditions of Tender and Contract for Road and Bridge Works", and copies may be obtained from H.M. Stationery Office.

GENERAL CONDITIONS OF CONTRACT.

**Definitions and Interpretation.**

1. In the Contract (as hereinafter defined) the following words and expressions shall have the meanings hereby assigned to them except where the context otherwise requires:—

- (a) "Employer" means.....  
of .....  
and includes the Employer's personal representatives or successors.
- (b) "Contractor" means the person or persons firm or company whose tender has been accepted by the Employer and includes the Contractor's personal representatives, successors and permitted assigns.
- (c) "Engineer" means.....  
or other Engineer appointed from time to time by the Employer and notified in writing to the Contractor to act as Engineer for the purposes of the Contract in place of the said.....
- (d) "Engineer's Representative" means any resident engineer or assistant of the Engineer or any clerk of works appointed from time to time by the Employer or the Engineer to perform the duties set forth in Clause 2 hereof whose authority shall be notified in writing to the Contractor by the Engineer
- (e) "Works" means the works to be executed in accordance with the Contract.
- (f) "Contract" means the General Conditions Specification Drawings priced Bill of Quantities Schedule of Rates and Prices (if any) Tender and the Contract Agreement.
- (g) "Contract Price" means the sum named in the Tender subject to such additions thereto or deductions therefrom as may be made under the provisions hereinafter contained
- (h) "Constructional Plant" means all appliances or things of whatsoever nature required in or about the execution completion or maintenance of the Works or Temporary Works (as hereinafter defined) but does not include materials or other things intended to form or forming part of the permanent work
- (i) "Temporary Works" means all temporary works of every kind required in or about the execution completion or maintenance of the Works.
- (j) "Drawings" means the drawings referred to in the Specification and any modification of such drawings approved in writing by the Engineer and such other drawings as may from time to time be furnished or approved in writing by the Engineer.
- (k) "Site" means the lands and other places on under in or through which the Works are to be executed or carried out and any other lands or places provided by the Employer for the purposes of the Contract

Words importing the singular only also include the plural and *vice versa* where the context requires.

The headings or notes in these General Conditions shall not be deemed to be part thereof or be taken into consideration in the interpretation or construction thereof or of the Contract.

**Engineer's Representative.**

2. The duties of the Engineer's Representative are to watch and supervise the Works and to test and examine any materials to be used or workmanship employed in connection with the Works. He shall have no authority to relieve the Contractor of any of his duties or obligations under the Contract nor except as expressly provided hereunder to order any work involving delay or any extra payment by the Employer nor to make any variation of or in the Works.

The Engineer shall from time to time in writing delegate to the Engineer's Representative any of the powers and authorities vested in the Engineer and shall furnish to the Contractor a copy of all such written delegations of powers and authorities. Any written instruction or written approval given by the Engineer's Representative to the Contractor within the terms of such delegation (but not otherwise) shall bind

the Contractor and the Employer as though it had been given by the Engineer. Provided always as follows:—

- (a) Failure of the Engineer's Representative to disapprove any work or materials shall not prejudice the power of the Engineer thereafter to disapprove such work or materials and to order the pulling down removal or breaking up thereof.
- (b) If the Contractor shall be dissatisfied by reason of any decision of the Engineer's Representative he shall be entitled to refer the matter to the Engineer who shall thereupon confirm reverse or vary such decision.

#### **Assignment and Sub-Letting.**

3. The Contractor shall not assign the Contract or any part thereof or any benefit or interest therein or thereunder without the written consent of the Employer.

4. The Contractor shall not sub-let the whole of the Works. Except where otherwise provided by the Contract the Contractor shall not sub-let any part of the Works without the written consent of the Engineer and such consent if given shall not relieve the Contractor from any liability or obligation under the Contract and he shall be responsible for the acts defaults and neglects of any Sub-Contractor his agents servants or workmen as fully as if they were the acts defaults or neglects of the Contractor his agents servants or workmen. Provided always that the provision of labour on a piece-work basis shall not be deemed to be a sub-letting under this clause.

#### **Extent of Contract.**

5. The Contract comprises the construction completion and maintenance of the Works and the provision of all labour materials constructional plant temporary works and everything whether of a temporary or permanent nature required in and for such construction completion and maintenance so far as the necessity for providing the same is specified in or reasonably to be inferred from the Contract.

#### **Contract Documents.**

6. **Documents Mutually Explanatory.**—The several documents forming the Contract are to be taken as mutually explanatory of one another and in case of ambiguities or discrepancies the same shall be explained and adjusted by the Engineer who shall thereupon issue to the Contractor instructions directing in what manner the work is to be carried out. Provided always that if in the opinion of the Engineer compliance with any such instructions shall involve the Contractor in any expense which by reason of any such ambiguity or discrepancy the Contractor did not and had reason not to anticipate the Engineer shall certify and the Employer shall pay such additional sum as may be reasonable to cover such expense.

7. **Drawings.**—The Drawings shall remain in the sole custody of the Engineer but two copies thereof shall be furnished to the Contractor free of cost. The Contractor shall provide and make at his own expense any further copies required by him. At the completion of the Contract the Contractor shall return to the Engineer all drawings provided under the Contract.

The Contractor shall give adequate notice in writing to the Engineer of any further drawing or specification that may be required for the execution of the Works or otherwise under the Contract.

One copy of the Drawings furnished to the Contractor as aforesaid shall be kept by the Contractor on the Site and the same shall at all reasonable times be available for inspection and use by the Engineer and the Engineer's Representative and by any other person authorised by the Engineer in writing.

8. **Further Drawings and Instructions.**—The Engineer shall have full power and authority to supply to the Contractor from time to time during the progress of the Works such further drawings and instructions as shall be necessary for the purpose of the proper and adequate execution and maintenance of the Works and the Contractor shall carry out and be bound by the same.

### General Obligations.

**9. Contract Agreement.**—The Contractor shall when called upon so to do enter into and execute a contract agreement (to be prepared at the cost of the Employer) in the form annexed with such modifications as may be necessary.

**10. Sureties.**—If the Tender shall contain an undertaking by the Contractor to provide when required two good and sufficient sureties or to obtain the guarantee of an Insurance Company or Bank to be jointly and severally bound with the Contractor in a sum not exceeding 10 per cent of the tender sum for the due performance of the Contract under the terms of a Bond the said sureties Insurance Company or Bank and the terms of the said Bond shall be such as shall be approved by the Employer and the provision of such sureties or the obtaining of such guarantee and the cost of the Bond to be so entered into shall be at the expense in all respects of the Contractor unless the Contract otherwise provides

**11. Inspection of Site.**—The Contractor shall inspect and examine the Site and its surroundings and shall satisfy himself before submitting his tender as to the nature of the ground and sub-soil (so far as is practicable) the form and nature of the Site the quantities and nature of the work and materials necessary for the completion of the Works and the means of access to the Site the accommodation he may require and in general shall himself obtain all necessary information (subject as above-mentioned) as to risks contingencies and other circumstances which may influence or affect his tender

**12. Sufficiency of Tender.** (1) The Contractor shall be deemed to have satisfied himself before tendering as to the correctness and sufficiency of his tender for the Works and of the rates and prices stated in the priced Bill of Quantities and the Schedule of Rates and Prices (if any) which rates and prices shall (except in so far as it is hereinafter otherwise provided) cover all his obligations under the Contract and all matters and things necessary for the proper completion and maintenance of the Works

(2) If however during the execution of the Works the Contractor shall encounter physical conditions (other than weather conditions or conditions due to weather conditions) or artificial obstructions which conditions or obstructions could not have been reasonably foreseen by an experienced contractor and the Contractor is of opinion that additional work or the use of additional Constructional Plant will be necessary which would not have been necessary if the physical conditions or artificial obstructions had not been encountered he shall if he intends to make any claim for additional payment give notice to the Engineer in writing specifying (a) the physical conditions and artificial obstructions encountered and (b) the additional work and additional Constructional Plant which he proposes to do and use (as the case may be) and (c) the extent of the anticipated delay in or interference with the execution of the work Provided always that the cost of all work done or Constructional Plant used by the Contractor prior to giving such notice and all work and Constructional Plant not specified in a notice given under this sub-clause shall be deemed to have been covered in the rates and prices referred to in sub-clause (1) of this Clause.

(3) Further if at the time of giving a notice under sub-clause (2) of this Clause the additional work and additional Constructional Plant which the Contractor proposes to do or use are then sufficiently defined to enable the Contractor to give a quotation for the payment of the cost thereof (including if practicable the cost of suffering the said delay or interference) he shall prepare and submit with such notice such a quotation and in all other cases the Contractor shall submit with such notice an estimate of the additional cost to the Contractor of doing the additional work and using the additional Constructional Plant and an estimate of the cost of the aforesaid delay or interference

(4) Upon receipt by the Engineer of a notice under sub-clause (2) of this Clause the Engineer shall investigate the claims thereon and may if he thinks fit do all or any of the following: (a) admit any of the facts and circumstances specified in the said notice; (b) give such Suspension Order under Clause 40 hereof or Variation Order under Clause 51 hereof as may in his opinion be appropriate in the circumstances including if he thinks fit an order to vary the Works so as to avoid the necessity for the doing

of the additional work or using the Constructional Plant so specified; and (c) accept the said quotation with or without admitting the Employer's liability for payment of the same and if such acceptance is made without admission of liability it shall not impose any obligation upon the Employer unless and until liability is either admitted or established. No decision of the Engineer under this sub-clause shall be valid unless it is in writing.

(5) Except in the case where the Engineer accepts the Contractor's quotation as aforesaid the Engineer shall be entitled as from the receipt of a notice under sub-clause (2) of this Clause to require in writing the Contractor to render to him from week to week an accurate return of all costs incurred by the Contractor in doing the additional work or in the use of the additional Constructional Plant which the Contractor alleges to be due to the physical conditions or artificial obstructions (as the case may be) and to provide all the necessary information and vouchers for the better checking of the additional cost and only such items of cost as have been furnished in accordance with the requirements of the Engineer under this Clause shall be admissible as the cost of such work and use of such plant.

(6) Unless otherwise admitted by the Engineer or subsequently agreed as a charge against the Employer all claims made under a notice given by the Contractor under sub-clause (2) of this Clause shall if the Contractor so requires be referred to an Arbitrator appointed as provided by Clause 66 hereof who if he is satisfied (a) that any of the physical conditions or artificial obstructions named in the notice were not such as an experienced contractor could have reasonably foreseen and (b) that the additional work or use of the additional Constructional Plant specified in the notice were necessitated thereby shall award that such reasonable cost as in his judgment he shall determine of doing the additional work and using the Constructional Plant specified in the said notice and of suffering any unavoidable delay or interference shall be paid by the Employer to the Contractor. Provided always that (1) if the Engineer shall have accepted the quotation of additional costs under sub-clause (4) of this Clause the Arbitrator shall not award any sum in excess of or less than such quotation except in respect of any matter expressly excluded therefrom and (ii) if the Arbitrator is satisfied as to (a) above and is not satisfied as to (b) above he may in making his award disallow the cost of any additional work or use of any additional Constructional Plant which he considers to have been unnecessary and award such lesser sum as he thinks fit.

(7) Nothing in this Clause shall prevent the Contractor giving a further notice under sub-clause (2) of this Clause should further or more extensive physical conditions or artificial obstructions within the meaning of that sub-clause be encountered by the Contractor in which case the remaining provisions of this Clause shall apply *mutatis mutandis*.

**13. Work to be to Satisfaction of Engineer.**—Save in so far as it is legally or physically impossible the Contractor shall execute complete and maintain the Works in strict accordance with the Contract to the satisfaction of the Engineer and shall comply with and adhere strictly to the Engineer's instructions and directions on any matter (whether mentioned in the Contract or not). The Contractor shall take instructions and directions only from the Engineer or (subject to the limitations referred to in Clause 2 hereof) from the Engineer's Representative.

**14. Programme to be Furnished.**—As soon as practicable after the acceptance of his tender the Contractor shall if required submit to the Engineer for his approval a programme showing the order of procedure and method in which he proposes to carry out the Works and shall whenever required by the Engineer furnish for his information particulars in writing of the Contractor's arrangements for the carrying out of the Works and of the Constructional Plant and Temporary Works which the Contractor intends to supply use or construct as the case may be. The submission to and approval by the Engineer of such programme or the furnishing of such particulars shall not relieve the Contractor of any of his duties or responsibilities under the Contract.

**15. Contractor's Superintendence.**—The Contractor shall give or provide all necessary superintendence during the execution of the Works and as long thereafter as the Engineer may consider necessary. The Contractor or a competent and authorised agent or representative approved of in writing by the Engineer (which approval may at any time be withdrawn) is to be constantly on the Works and shall give his whole

time to the superintendence of the same. Such authorised agent or representative shall receive on behalf of the Contractor directions and instructions from the Engineer or (subject to the limitations of Clause 2 hereof) the Engineer's Representative.

**16. Removal of Workmen.**—The Contractor shall employ in and about the execution of the Works only such persons as are careful skilled and experienced in their several trades and callings and the Engineer shall be at liberty to object to and require the Contractor to remove from the Works any person employed by the Contractor in or about the execution of the Works who in the opinion of the Engineer misconducts himself or is incompetent or negligent in the proper performance of his duties and such persons shall not be again employed upon the Works without the permission of the Engineer.

**17. Setting-Out.**—The Contractor shall be responsible for the true and proper setting-out of the Works and for the correctness of the position levels dimensions and alignment of all parts of the Works and for the provision of all necessary instruments appliances and labour in connection therewith. If at any time during the progress of the Works any error shall appear or arise in the position levels dimensions or alignment of any part of the Works the Contractor on being required so to do by the Engineer shall at his own expense rectify such error to the satisfaction of the Engineer unless such error is based on incorrect data supplied in writing by the Engineer or the Engineer's Representative in which case the expense of rectifying the same shall be borne by the Employer. The checking of any setting-out or of any line or level by the Engineer or the Engineer's Representative shall not in any way relieve the Contractor of his responsibility for the correctness thereof and the Contractor shall carefully protect and preserve all bench-marks site-rails pegs and other things used in setting out the Works.

**18. Boreholes and Exploratory Excavation.**—If at any time during the execution of the Works the Engineer shall require the Contractor to make boreholes or to carry out exploratory excavation such requirement shall be ordered in writing and shall be deemed to be an addition ordered under the provisions of Clause 51 hereof unless a provisional sum in respect of such anticipated work shall have been included in the Bill of Quantities.

**19. Watching and Lighting.**—The Contractor shall in connection with the Works provide and maintain at his own cost all lights guards fencing and watching when and where necessary or required by the Engineer or by any competent statutory or other authority for the protection of the Works or for the safety and convenience of the public or others.

**20. Care of Works.**—From the commencement to the completion of the Works the Contractor shall take full responsibility for the care thereof and of all Temporary Works and in case any damage loss or injury shall happen to the Works or to any part thereof or to any Temporary Works from any cause whatsoever (save and except the excepted risks as defined in sub-clause (2) of this Clause) shall at his own cost repair and make good the same so that at completion the Works shall be in good order and condition and in conformity in every respect with the requirements of the Contract and the Engineer's instructions. In the event of any such damage loss or injury happening from any of the excepted risks the Contractor shall if and to the extent required by the Engineer and subject always to the provisions of Clause 65 hereof repair and make good the same as aforesaid at the cost of the Employer. The Contractor shall also be liable for any damage to the Works occasioned by him in the course of any operations carried out by him for the purpose of complying with his obligations under Clause 49 hereof.

The "excepted risks" are riot (in so far as it is uninsurable) war invasion act of foreign enemies hostilities (whether war be declared or not) civil war rebellion revolution insurrection or military or usurped power or a cause solely due to use or occupation by the Employer of any portion of the Works in respect of which a Certificate of Completion has been issued or a cause solely due to the Engineer's design of the Works (all of which are herein collectively referred to as "the excepted risks").

**21. Insurance of Works.**—Without limiting his obligations and responsibilities under Clause 20 hereof the Contractor shall insure in the joint names of the Employer and the Contractor against all loss or damage from whatever cause arising (other than

the excepted risks) for which he is responsible under the terms of the Contract and in such manner that the Employer and Contractor are covered during the period of construction of the Works and are also covered during the Period of Maintenance for loss or damage arising from a cause occurring prior to the commencement of the Period of Maintenance and for any loss or damage occasioned by the Contractor in the course of any operations carried out by him for the purpose of complying with his obligations under Clause 49 hereof. (a) the Works and the Temporary Works to the full value of such works executed from time to time, (b) the materials Constructional Plant and other things brought on to the Site by the Contractor to the full value of such materials Constructional Plant and other things. Provided that without limiting his obligations and responsibilities as aforesaid, nothing in this Clause contained shall render the Contractor liable to insure against the necessity for the repair or reconstruction of any work constructed with materials or workmanship not in accordance with the requirements of the Contract unless the Bills of Quantities shall provide a special item for this insurance. Such insurances shall be effected with an insurer and in terms approved by the Employer (which approval shall not be unreasonably withheld) and the Contractor shall whenever required produce to the Employer the policy or policies of insurance and the receipts for payment of the current premiums.

**22. Damage to Persons and Property.**—(1) The Contractor shall (except in and so far as the Specification otherwise provides) indemnify and keep indemnified the Employer against all losses and claims for injuries or damage to any person or property whatsoever (including surface or other damage to land being or crops being on the Site suffered by tenants or occupiers) which may arise out of or in consequence of the construction and maintenance of the Works and against all claims demands proceedings damages costs charges and expenses whatsoever in respect thereof or in relation thereto. Provided always that nothing herein contained shall be deemed to render the Contractor liable for or in respect of or to indemnify the Employer against any compensation or damage for or with respect to: (a) the permanent use or occupation of land by the Works or any part thereof (save in respect of damage to crops as aforesaid); (b) the right of the Employer to construct the Works or any part thereof on over under in or through any land; (c) interference whether temporary or permanent with any right of light air way or water or other easement or quasi-easement which is the unavoidable result of the construction of the Works in accordance with the Contract, (d) injuries or damage to persons or property resulting from any act or neglect done or committed during the currency of the contract by the Employer his agents servants or other contractors (not being employed by the Contractor) or for or in respect of any claims demands proceedings damages costs charges and expenses in respect thereof or in relation thereto.

(2) The Employer will save harmless and indemnify the Contractor from and against all claims demands proceedings damages costs charges and expenses in respect of the matters referred to in the proviso to sub-clause (1) of this Clause.

**23. Third Party Insurance.**—(1) Upon the execution of the Contract the Contractor (but without limiting his obligations and responsibilities under Clause 22 hereof) shall insure in the joint names of the Contractor and Employer against any damage loss or injury which may occur to any property or to any person by or arising out of the execution of the Works or Temporary Works or in the carrying out of the Contract otherwise than due to the matters referred to in the proviso to Clause 22 (1) hereof.

(2) Such insurance shall be effected with an insurer and in terms approved by the Employer (which approval shall not be unreasonably withheld) and for at least the amount stated in the Tender and the Contractor shall whenever required produce to the Employer the policy or policies of insurance and the receipts for payment of the current premiums.

**24. Accident or Injury to Workmen.**—(1) The Employer shall not be liable for or in respect of any damages or compensation payable at Law in respect or in consequence of any accident or injury to any workman or other person in the employment of the Contractor or any sub-contractor save and except an accident or injury resulting from any act or default of the Employer his agents or servants and the Contractor shall indemnify and keep indemnified the Employer against all such



damages and compensation (save and except as aforesaid) and against all claims demands proceedings costs charges and expenses whatsoever in respect thereof or in relation thereto.

(2) The Contractor shall insure against such liability with an insurer approved by the Employer (which approval shall not be unreasonably withheld) and shall continue such insurance during the whole of the time that any persons are employed by him on the Works and shall when required produce to the Engineer such policy of insurance and the receipt for payment of the current premium. Provided always that in respect of any persons employed by any sub-contractor the Contractor's obligation to insure as aforesaid under this sub-clause shall be satisfied if the sub-contractor shall have insured against the liability in respect of such persons in such manner that the Employer is indemnified under the policy but the Contractor shall require such sub-contractor to produce to the Employer when required such policy of insurance and the receipt for payment of the current premium.

**25. Remedy on Contractor's Failure to Insure.**—If the Contractor shall fail to effect and keep in force the insurances referred to in Clauses 21, 23 and 24 hereof or any other insurance which he may be required to effect under the terms of the Contract then and in any such case the Employer may effect and keep in force any such insurance and pay such premium or premiums as may be necessary for that purpose and from time to time deduct the amount so paid by the Employer as aforesaid from any monies due or which may become due to the Contractor or recover the same as a debt from the Contractor.

**26. Giving of Notices and Payment of Fees.**—The Contractor shall save as provided in Clause 26A hereof give all notices and pay all fees required to be given or paid by any Act of Parliament or any Regulation or Bye-law of any local or other statutory authority in relation to the execution of the Works or of any Temporary Works and by the rules and regulations of all public bodies and companies whose property or rights are affected or may be affected in any way by the Works or any Temporary Works. The Contractor shall conform in all respects with the provisions of any general or local Act of Parliament and the Regulations or Bye-laws of any local or other statutory authority which may be applicable to the Works or to any Temporary Works and with such rules and regulations of public bodies and companies as aforesaid and shall keep the Employer indemnified against all penalties and liability of every kind for breach of any such Act Regulation or Bye-law. The Employer will repay or allow to the Contractor all such sums as the Engineer shall certify to have been properly payable and paid by the Contractor in respect of such fees and also all rates and taxes paid by the Contractor in respect of the Site or any part thereof or anything constructed or erected thereon or on any part thereof or any temporary structures situate elsewhere but used exclusively for the purposes of the Works. Provided always that the Contractor shall not be responsible for obtaining any planning permission which may be necessary in relation to the Works and the Employer hereby warrants that all the said permissions have been obtained.

**26A.** (1) For the purposes of this Clause: (a) The expression "the Act" shall mean and include the Public Utilities Street Works Act 1950, and any statutory modification or re-enactment thereof for the time being in force (b) All other expressions common to the Act and to this Clause shall have the same meaning as that assigned to them by the Act. (2) The Employer shall before the commencement of the Works notify the Contractor in writing: (a) Whether the Works or any portions thereof (and if so which portions) are Emergency Works and (b) Which (if any) portions of the Works are to be carried out in Controlled Land or in a Prospectively Maintainable Highway. If any duly authorised variation of the Works shall involve the execution thereof in a Street or in Controlled Land or in a Prospectively Maintainable Highway or are Emergency Works the Employer shall notify the Contractor in writing accordingly at the time such variation is ordered.

(3) The Employer shall (subject to the obligations of the Contractor under sub-clause (4) hereof) serve all such notices as may from time to time whether before or during the course of or after completion of the Works be required to be served under the Act.

(4) The Contractor shall in relation to any part of the Works (other than

Emergency Works) and subject to compliance by the Employer with the provisions of sub-clause (3) of this Clause give not less than 21 days' notice in writing to the Employer before (a) commencing any part of the Works in a Street (as defined by Sections 1 (3) and 38(1) of the Act); or (b) commencing any part of the Works in Controlled Land or in a Prospectively Maintainable Highway; or (c) commencing in a Street or in Controlled Land or in a Prospectively Maintainable Highway any part of the Works which is likely to affect the apparatus of any Owning Undertaker (within the meaning of Clause 26 of the Act). Such notice shall state the date on which and the place at which the Contractor intends to commence the execution of the work referred to therein.

(5) If the Contractor having given any such notice as is required by sub-clause (4) of this Clause shall not commence the part of the Works to which such notice relates within two months after the date when such notice is given such notice shall be treated as invalid and compliance with the provisions of the said sub-clause (4) shall be requisite as if such notice had not been given.

(6) In the event of such a variation of the Works as is referred to in sub-clause (2) of this Clause being ordered by or on behalf of the Employer and resulting in delay in the execution of the Works by reason of the necessity of compliance by the Contractor with the provisions of sub-clause (4) of this Clause the Contractor shall be entitled to a reasonable extension of time under Clause 44 hereof and to payment by the Employer of such additional costs as the Engineer shall certify to have been reasonably attributable to such delay.

(7) Except as otherwise provided by this Clause where, in relation to the carrying out of the Works, the Act imposes any requirements or obligations upon the Employer, the Contractor shall subject to the provisions of Clause 49 (5) hereof comply with such requirements and obligations and shall (subject as aforesaid) indemnify the Employer against any liability which the Employer may incur in consequence of any failure to comply with the said requirements and obligations.

**27. Fossils, etc.**—All fossils coins articles of value or antiquity and structures and other remains or things of geological or archaeological interest discovered on the site of the Works shall as between the Employer and the Contractor be deemed to be the absolute property of the Employer and the Contractor shall take reasonable precautions to prevent his workmen or any other persons from removing or damaging any such article or thing and shall immediately upon discovery thereof and before removal acquaint the Engineer of such discovery and carry out at the expense of the Employer the Engineer's orders as to the disposal of the same.

**28. Patent Rights and Royalties.**—The Contractor shall save harmless and indemnify the Employer from and against all claims and proceedings for or on account of infringement of any patent rights design trade-mark or name or other protected rights in respect of any Constructional Plant machine work or material used for or in connection with the Works or Temporary Works or any of them and from and against all claims demands proceedings damages costs charges and expenses whatsoever in respect thereof or in relation thereto. Except where otherwise specified the Contractor shall pay all tonnage and other royalties rent and other payments or compensation (if any) for getting stone sand gravel clay or other materials required for the Works or Temporary Works or any of them.

**29. Interference with Traffic and Adjoining Properties.**—All operations necessary for the execution of the Works and for the construction of any Temporary Works shall so far as compliance with the requirements of the Contract permits be carried on so as not to interfere unnecessarily or improperly with the public convenience or the access to use and occupation of public or private roads and footpaths or to or of properties whether in the possession of the Employer or of any other person and the Contractor shall save harmless and indemnify the Employer in respect of all claims demands proceedings damages costs charges and expenses whatsoever arising out of or in relation to any such matters.

**30. Extraordinary Traffic.**—The Contractor shall use every reasonable means to prevent any of the highways or bridges communicating with or on the routes to the Site from being subjected to extraordinary traffic within the meaning of the Road Traffic Act, 1930 (hereinafter called "the Act of 1930") by any traffic of the Contractor

or any of his sub-contractors and in particular shall select routes choose and use vehicles and restrict and distribute loads so that any such extraordinary traffic as will inevitably arise from the moving of plant and material from and to the Site shall be limited as far as reasonably possible and so that no unnecessary damage or injury may be occasioned to such highways and bridges.

(2) Should it be found necessary for the Contractor to move one or more loads of Constructional Plant machinery or pre-constructed units or parts of units of work over part of a highway or bridge and that the moving of such load must in all probability damage the highway or bridge unless means of protection or strengthening are carried out then the Contractor shall before moving the load on to such highway or bridge give notice to the Engineer of the weight and other particulars of the load to be moved and his proposals for protecting or strengthening the said highway or bridge. Unless within fourteen days of the receipt of such notice the Engineer shall by counternotice decide that such protection or strengthening is unnecessary then the Contractor will carry out such proposals or any modification thereof that the Engineer shall require and unless there is an item or are items in the Bill of Quantities for the pricing by the Contractor of the necessary works for the protection or strengthening aforesaid the costs and expenses thereof shall be paid by the Employer to the Contractor.

(3) If during the carrying out of the Works or at any time thereafter the Contractor shall receive any claim under the Act of 1930 or any statutory modification or re-enactment thereof for the time being in force in respect of damage or injury to highways or bridges by reason of extraordinary traffic he shall immediately report the same to the Engineer and thereafter the Employer shall negotiate the settlement of and pay all sums due in respect of such claim and shall indemnify the Contractor in respect thereof and in respect of all claims demands proceedings damages costs charges and expenses in relation thereto. Provided always that if and so far as any such claims or part thereof shall in the opinion of the Engineer be due to any failure on the part of the Contractor to observe and perform his obligations under sub-clauses (1) and (2) of this Clause then the amount certified by the Engineer to be due to such failure shall be paid by the Contractor to the Employer.

**31. Facilities for Other Contractors.**—The Contractor shall in accordance with the requirements of the Engineer afford all reasonable facilities for any other contractors employed by the Employer and their workmen and for the workmen of the Employer and of any other properly authorised authorities or statutory bodies who may be employed in the execution on or near the Site of any work not included in the Contract or of any Contract which the Employer may enter into in connection with or ancillary to the Works.

**32. Supply of Plant Material and Labour.**—Except where otherwise specified the Contractor shall at his own expense supply and provide all the Constructional Plant Temporary Works materials both for temporary and for permanent works labour (including the supervision thereof) transport to or from the site and in and about the Works and other things of every kind required for the construction completion and maintenance of the Works.

**33. Clearance of Site on Completion.**—On the completion of the Works the Contractor shall clear away and remove from the Site all Constructional Plant surplus materials rubbish and Temporary Works of every kind and leave the whole of the Site and Works clean and in a workmanlike condition to the satisfaction of the Engineer.

#### **Labour.**

**34. (1) (a)** The Contractor shall pay rates of wages and observe hours and conditions of labour not less favourable than those established for the trade or industry in the district where the work is carried out by machinery of negotiation or arbitration to which the parties are organisations of employers and trade unions representative respectively of substantial proportions of the employers and workers engaged in the trade or industry in the district. **(b)** In the absence of any rates of wages hours or conditions of labour so established the Contractor shall pay rates of wages and observe hours and conditions of labour which are not less favourable than the general level of wages hours and conditions observed by other employers whose general circumstances in the trade or industry in which the Contractor is engaged are similar.

(2) The Contractor shall in respect of all persons employed by him (whether in the execution of the Contract or otherwise) in every factory workshop or place used by him for the execution of the Contract comply with the general conditions of this Clause and if required by the Employer shall before entering into the Contract certify that to the best of his knowledge and belief he has complied with such general conditions for the three months immediately preceding the date of submission of the Contractor's Tender.

(3) The Contractor shall recognise the freedom of his workpeople to be members of trade unions

(4) The Contractor shall at all times during the continuance of the Contract display for the information of his workpeople in any factory workshop or place occupied or used by him for the execution of the Contract a copy of this Clause

(5) The Contractor shall be responsible for the observance of the provisions of this Clause by sub-contractors employed by him in the execution of the Contract

(6) The wages hours and conditions of employment above referred to shall be those prescribed for the time being by the Civil Engineering Construction Conciliation Board for Great Britain save that the rates of wages payable to any class of labour in respect of which the said Board does not prescribe a rate shall be governed by the provisions of sub-clause (1) of this Clause.

**35. Returns of Labour, etc.**—The Contractor shall if required by the Engineer deliver to the Engineer or at his office a return in such form and at such intervals as the Engineer may prescribe showing in detail the numbers of the several classes of labour from time to time employed by the Contractor on the Site and such information respecting Constructional Plant as the Engineer may require.

#### Work Materials and Plant.

**36. Quality of Materials and Workmanship and Tests.**—All materials and workmanship shall be of the respective kinds described in the Contract and in accordance with the Engineer's instructions and shall be subjected from time to time to such tests as the Engineer may direct at the place of manufacture or fabrication or on the Site or at all or any of such places The Contractor shall provide such assistance instruments machines labour and materials as are normally required for examining measuring and testing any work and the quality weight or quantity of any material used and shall supply samples of materials before incorporation in the Works for testing as may be selected and required by the Engineer

All samples shall be supplied by the Contractor at his own cost if the supply thereof is clearly intended by or provided for in the Specification or Bill of Quantities but if not then at the cost of the Employer

The cost of making any test shall be borne by the Contractor if such test is clearly intended by or provided for in the Specification or Bill of Quantities and (in the cases only of a test under load or of a test to ascertain whether the design of any finished or partially finished work is appropriate for the purposes which it was intended to fulfil) is particularised in the Specification or Bill of Quantities in sufficient detail to enable the Contractor to price or allow for the same in his Tender

If any test is ordered by the Engineer which is either (a) not so intended by or provided for or (b) (in the cases above mentioned) is not so particularised or (c) though so intended or provided for is ordered by the Engineer to be carried out by an independent person at any place other than the Site or the place of manufacture or fabrication of the materials tested then the cost of such test shall be borne by the Contractor if the test shows the workmanship or materials not to be in accordance with the provisions of the Contract or the Engineer's instructions but otherwise by the Employer

**37. Access to Site.**—The Engineer and any person authorised by him shall at all times have access to the Works and to the Site and to all workshops and places where work is being prepared or whence materials manufactured articles and machinery are being obtained for the Works and the Contractor shall afford every facility for and every assistance in or in obtaining the right to such access.

**38. Examination of Work before Covering.**—(i) No work shall be covered up or put out of view without the approval of the Engineer and the Contractor shall afford full opportunity for the Engineer to examine and measure any work which

is about to be covered up or put out of view and to examine foundations before permanent work is placed thereon. The Contractor shall give due notice to the Engineer whenever any such work or foundations is or are ready or about to be ready for examination and the Engineer shall without unreasonable delay unless he considers it unnecessary and advises the Contractor accordingly attend for the purpose of examining and measuring such work or of examining such foundations

(ii) The Contractor shall uncover any part or parts of the Works or make openings in or through the same as the Engineer may from time to time direct and shall reinstat and make good such part or parts to the satisfaction of the Engineer. If any such part or parts have been covered up or put out of view after compliance with the requirements of sub-clause (i) of this Clause and are found to be executed in accordance with the Contract the expenses of uncovering making openings in or through reinstating and making good the same shall be borne by the Employer but in any other case all such expenses shall be borne by the Contractor and shall be recoverable from him by the Employer or may be deducted by the Employer from any monies due or which may become due to the Contractor.

**39. Removal of Improper Work and Materials.**—The Engineer shall during the progress of the Works have power to order in writing from time to time

- (a) The removal from the Site within such time or times as may be specified in the order of any materials which in the opinion of the Engineer are not in accordance with the Contract
- (b) The substitution of proper and suitable materials and
- (c) The removal and proper re-execution (notwithstanding any previous test thereof or interim payment thereof) of any work which in respect of materials or workmanship is not in the opinion of the Engineer in accordance with the Contract.

In case of default on the part of the Contractor in carrying out such order the Employer shall be entitled to employ and pay other persons to carry out the same and all expenses consequent thereon or incidental thereto shall be borne by the Contractor and shall be recoverable from him by the Employer or may be deducted by the Employer from any monies due or which may become due to the Contractor.

**40. Suspension of Work.**—The Contractor shall on the written order of the Engineer suspend the progress of the Works or any part thereof for such time or times and in such manner as the Engineer may consider necessary and shall during such suspension properly protect and secure the work so far as is necessary in the opinion of the Engineer. The extra cost (if any) incurred by the Contractor in giving effect to the Engineer's instructions under this Clause shall be borne and paid by the Employer unless such suspension is

- (a) otherwise provided for in the Contract or
- (b) necessary for the proper execution of the work or by reason of weather conditions or by some default on the part of the Contractor or
- (c) necessary for the safety of the Works or any part thereof

Provided that the Contractor shall not be entitled to recover any such extra cost unless he gives notice in writing of his intention to claim to the Engineer within 28 days of the Engineer's order. The Engineer shall settle and determine the extra payment to be made to the Contractor in respect of such claim as the Engineer shall consider fair and reasonable.

If the progress of the works or any part thereof is suspended on the written order of the Engineer for more than three months the Contractor may serve a written notice on the Engineer requiring permission within 28 days from the receipt thereof to proceed with the Works or that part thereof in regard to which progress is suspended and if such permission is not granted within that time the Contractor by a further written notice so served may (but is not bound to) elect to treat the suspension where it affects part only of the Works as an omission of such part under Clause 51 hereof or where it affects the whole Works as an abandonment of the Contract by the Employer.

#### Commencement Time and Delays.

**41. Commencement of Works.**—The Contractor shall commence the Works within 14 days after the receipt by him of an order in writing to this effect from the

Engineer and shall proceed with the same with due expedition and without delay except as may be expressly sanctioned or ordered by the Engineer or be beyond the Contractor's control.

**42. Possession of Site.**—Save in so far as the Contract may prescribe the extent of portions of the Site of which the Contractor is to be given possession from time to time and the order in which such portions shall be made available to him and subject to any requirement in the Contract as to the order in which the Works shall be executed the Employer will with the Engineer's written order to commence the Works give to the Contractor possession of so much of the Site as may be required to enable the Contractor to commence and proceed with the construction of the Works in accordance with the programme referred to in Clause 14 hereof (if any) and otherwise in accordance with such reasonable proposals of the Contractor as he shall by notice in writing to the Engineer make and will from time to time as the Works proceed give to the Contractor possession of such further portions of the Site as may be required to enable the Contractor to proceed with the construction of the Works with due despatch in accordance with the said programme or proposals as the case may be. If the Contractor suffers delay or incurs expense from failure on the part of the Employer to give possession in accordance with the terms of this Clause the Engineer shall grant an extension of time for the completion of the Works and certify such sum as he considers fair to cover the expense incurred which sum shall be paid by the Employer.

The Contractor shall bear all expenses and charges for special or temporary wayleaves required by him in connection with access to the Site. The Contractor shall also provide at his own cost any additional accommodation outside the Site required by him for the purposes of the Works.

**43. Time for Completion.**—Subject to any requirement in the Specification as to completion of any portion of the Works before completion of the whole the whole of the Works shall be completed within the time stated in the Tender calculated from the date of the Engineer's written order to commence the Works or such extended time as may be allowed under Clause 44 hereof.

**44. Extension of Time for Completion.**—Should the amount of extra or additional work of any kind or other special circumstances of any kind whatsoever which may occur be such as fairly to entitle the Contractor to an extension of time for the completion of the work the Engineer shall determine the amount of such extension. Provided that the Engineer is not bound to take into account any extra or additional work or other special circumstances unless the Contractor has within 28 days after such work has been commenced or such circumstances have arisen or as soon thereafter as is practicable delivered to the Engineer full and detailed particulars of any claim to extension of time to which he may consider himself entitled in order that such claim may be investigated at the time.

**45. No Night or Sunday Work.**—Subject to any provision to the contrary contained in the Contract none of the permanent work shall save as hereinafter provided be carried on during the night or on Sundays without the permission in writing of the Engineer save when the work is unavoidable or absolutely necessary for the saving of life or property or for the safety of the Works in which case the Contractor shall immediately advise the Engineer's Representative. Provided always that the provisions of this Clause shall not be applicable in the case of any work which it is customary to carry out by rotary or double shifts.

**46. Rate of Progress.**—The whole of the materials plant and labour to be provided by the Contractor under Clause 5 hereof and the mode manner and speed of execution and maintenance of the Works are to be of a kind and conducted in a manner approved of by the Engineer. Should the rate of progress of the Works or any part thereof be at any time in the opinion of the Engineer too slow to ensure the completion of the Works by the prescribed time or extended time for completion the Engineer shall so notify the Contractor in writing and the Contractor shall thereupon take such steps as the Contractor may think necessary and the Engineer may approve to expedite progress so as to complete the Works by the prescribed time or extended time for completion. If the work is not being carried on by day and by night and the Contractor shall request permission to work by night as well as by day

then if the Engineer shall grant such permission the Contractor shall not be entitled to any additional payment for so doing but if such permission shall be refused and there shall be no equivalent practicable method of expediting the progress of the work the time for completion of the Works shall be extended by the Engineer by such period as is solely attributable to such refusal. All work at night shall be carried out without unreasonable noise and disturbance. The Contractor shall indemnify the Employer from and against any liability for damages on account of noise or other disturbance created while or in carrying out the work and from and against all claims demands proceedings costs and expenses whatsoever in regard or in relation to such liability

**47. Liquidated Damages for Delay.**—If the Contractor shall fail to complete the Works within the time prescribed by Clause 43 hereof or extended time then the Contractor shall pay to the Employer the sum stated in the Tender as liquidated damages for such default and not as a penalty for every week or part of a week which shall elapse between the time prescribed by Clause 43 hereof or extended time as the case may be and the date of completion of the Works. The Employer may without prejudice to any other method of recovery deduct the amount of such damages from any monies in his hands due or which may become due to the Contractor. The payment or deduction of such damages shall not relieve the Contractor from his obligation to complete the Works or from any other of his obligations and liabilities under the Contract

If before the completion of the whole of the Works any part of the Works has been certified by the Engineer as completed pursuant to Clause 48 hereof and occupied or used by the Employer the liquidated damages for delay shall for any period of delay after such certification be reduced in the proportion which the value of the part so certified bears to the value of the whole of the Works

**48. Certificate of Completion of Works.**—As soon as in the opinion of the Engineer the Works shall have been substantially completed and shall have satisfactorily passed any final test that may be prescribed by the Contract the Engineer shall on receiving a written undertaking by the Contractor to finish any outstanding work during the Period of Maintenance issue a Certificate of Completion in respect of the Works and the Period of Maintenance of the Works shall commence from the date of such certificate. Provided that the Engineer may give such a certificate with respect to any part of the Works before the completion of the whole of the Works and shall upon the written application of the Contractor give such certificate with respect to any substantial part of the Works which has been both completed to the satisfaction of the Engineer and occupied or used by the Employer and when any such certificate is given in respect of a part of the Works such part shall be considered as completed and the Period of Maintenance of such part shall commence from the date of such certificate. Provided always that a Certificate of Completion given in accordance with the foregoing provisions of any part of the Works occupied and used as aforesaid shall not be deemed to certify completion of any ground or surface requiring reinstatement unless such certificate shall expressly so state.

### **Maintenance and Defects.**

**49. Maintenance.**—(1) In these Conditions the expression "Period of Maintenance" shall mean the period of maintenance named in the Tender calculated from the date of completion of the Works certified by the Engineer in accordance with Clause 48 hereof or in the event of more than one certificate having been issued by the Engineer under the said Clause from the respective dates so certified and in relation to the Period of Maintenance the expression "the Works" shall be construed accordingly.

(2) To the intent that the Works shall at or as soon as practicable after the expiration of the period of Maintenance be delivered up to the Employer in as good and perfect a condition (fair wear and tear excepted) to the satisfaction of the Engineer as that in which they were at the commencement of the Period of Maintenance the Contractor shall execute all such work of repair amendment reconstruction rectification and making good of defects imperfections shrinkages or other faults as may be required of the Contractor in writing by the Engineer during the period of Maintenance

or within fourteen days after its expiration as a result of an inspection made by or on behalf of the Engineer prior to its expiration.

(3) All such work shall be carried out by the Contractor at his own expense if the necessity thereof shall in the opinion of the Engineer be due to the use of materials or workmanship not in accordance with the Contract or to neglect or failure on the part of the Contractor to comply with any obligation expressed or implied on the Contractor's part under the Contract. If in the opinion of the Engineer such necessity shall be due to any other cause the value of such work shall be ascertained and paid for as if it were additional work

(4) If the Contractor shall fail to do any such work as aforesaid required by the Engineer the Employer shall be entitled to carry out such work by his own workmen or by other Contractors and if such work is work which the Contractor should have carried out at the Contractor's own cost shall be entitled to recover from the Contractor the cost thereof or may deduct the same from any monies due or that become due to the Contractor

(5) Provided always that if in the course or for the purposes of the execution of the Works or any part thereof any highway or other road or way shall have been broken into then notwithstanding anything herein contained (a) If the permanent reinstatement of such highway or other road or way is to be carried out by the appropriate Highway Authority or by some person other than the Contractor (or any sub-contractor to him) the Contractor shall at his own cost and independently of any requirement of or notice from the Engineer be responsible for the making good of any subsidence or shrinkage or other defect imperfection or fault in the temporary reinstatement of such highway or other road or way and for the execution of any necessary repair or amendment thereof from whatever cause the necessity arises until the end of the Period of Maintenance in respect of the works beneath such highway or other road or way or until the Highway Authority or other person as aforesaid shall have taken possession of the Site for the purpose of carrying out permanent reinstatement (whichever is the earlier) and shall indemnify and save harmless the Employer against and from any damage or injury to the Employer or to third parties arising out or in consequence of any neglect or failure of the Contractor to comply with the foregoing obligations or any of them and against and from all claims demands proceedings damages costs charges and expenses whatsoever in respect thereof or in relation thereto. As from the end of such Period of Maintenance or the taking of possession as aforesaid (whichever shall first happen) the Employer shall indemnify and save harmless the Contractor against and from any damage or injury as aforesaid arising out or in consequence of or in connection with the said permanent reinstatement or any defect imperfection or failure of or in such work of permanent reinstatement and against and from all claims demands proceedings damages costs charges and expenses whatsoever in respect thereof or in relation thereto (b) Where the Highway Authority or other person as aforesaid shall take possession of the Site as aforesaid in sections or lengths the responsibility of the Contractor under paragraph (a) of this sub-clause shall cease in regard to any such section or length at the time possession thereof is so taken but shall during the continuance of the said Period of Maintenance continue in regard to any length of which possession has not been so taken and the indemnities given by the Contractor and the Employer respectively under the said paragraph shall be construed and have effect accordingly.

**50. Contractor to Search.**—The Contractor shall if required by the Engineer in writing search for the cause of any defect imperfection or fault under the directions of the Engineer. Unless such defect imperfection or fault shall be one for which the Contractor is liable under the Contract the cost of the work carried out by the Contractor in searching as aforesaid shall be borne by the Employer. But if such defect imperfection or default shall be one for which the Contractor is liable as aforesaid the cost of the work carried out in searching as aforesaid shall be borne by the Contractor and he shall in such case repair rectify and make good such defect imperfection or default at his own expense in accordance with the provisions of Clause 49 hereof.



**Alterations, Additions, and Omissions**

**51. Variations.**—The Engineer shall make any variation of the form quality or quantity of the Works or any part thereof that may in his opinion be necessary and for that purpose or if for any other reason it shall in his opinion be desirable shall have power to order the Contractor to do and the Contractor shall do any of the following :—

- (a) increase or decrease the quantity of any work included in the Contract
  - (b) omit any such work
  - (c) change the character or quality or kind of any such work
  - (d) change the levels lines position and dimensions of any part of the Works and
  - (e) execute additional work of any kind necessary for the completion of the Works
- and no such variation shall in any way vitiate or invalidate the Contract but the value (if any) of all such variations shall be taken into account in ascertaining the amount of the Contract Price.

No such variation shall be made by the Contractor without an order in writing of the Engineer. Provided that no order in writing shall be required for increase or decrease in the quantity of any work where such increase or decrease is not the result of an order given under this Clause but is the result of the quantities exceeding or being less than those stated in the Bill of Quantities. Provided also that if for any reason the Engineer shall consider it desirable to give any such order verbally the Contractor shall comply with such order and any confirmation in writing of such verbal order given by the Engineer whether before or after the carrying out of the order shall be deemed to be an order in writing within the meaning of this Clause. Provided further that if the Contractor shall confirm in writing to the Engineer any verbal order of the Engineer and such confirmation shall not be contradicted in writing by the Engineer it shall be deemed to be an order in writing by the Engineer.

**52. Valuation of Variations.**—(i) The Engineer shall determine the amount (if any) to be added to or deducted from the sum named in the Tender in respect of any extra or additional work done or work omitted by his order. All such work shall be valued at the rates set out in the Contract if in the opinion of the Engineer the same shall be applicable. If the Contract shall not contain any rates applicable to the extra or additional work then reasonable prices shall be fixed by the Engineer.

(ii) Provided that if the nature or amount of any omission or addition relative to the nature or amount of the whole of the contract work or to any part thereof shall be such that in the opinion of the Engineer the rate or price contained in the Contract for any item of the Works is by reason of such omission or addition rendered unreasonable or inapplicable the Engineer shall fix such other rate or price as in the circumstances he shall think reasonable and proper.

Provided also that no increase of the Contract Price under sub-clause (i) of this Clause or variation of rate or price under sub-clause (ii) of this Clause shall be made unless as soon after the date of the order as is practicable and in the case of extra or additional work before the commencement of the work or as soon thereafter as is practicable notice shall have been given in writing :—

- (a) by the Contractor to the Engineer of his intention to claim extra payment or a varied rate or
- (b) by the Engineer to the Contractor of his intention to vary a rate or price as the case may be.

(iii) The Engineer may if in his opinion it is necessary or desirable order that any additional or substituted work shall be executed on a daywork basis. The Contractor shall then be paid for such work under the conditions set out in the Daywork Schedule included in the Bill of Quantities and at the rates and prices affixed thereto by him in his tender and failing the provision of a Daywork Schedule he shall be paid at the rates and prices and under the conditions contained in the " Schedule of Daywork carried out incidental to Contract Work " issued by The Federation of Civil Engineering Contractors current at the date of submission of the Contractor's Tender for the execution of the Works.

The Contractor shall furnish to the Engineer such receipts or other vouchers as

may be necessary to prove the amounts paid and before ordering materials shall submit to the Engineer quotations for the same for his approval.

In respect of all work executed on a daywork basis the Contractor shall during the continuance of such work deliver each day to the Engineer's Representative an exact list in duplicate of the names occupation and time of all workmen employed on such work and a statement also in duplicate showing the description and quantity of all materials and plant used thereon or therefor (other than plant which is included in the percentage addition in accordance with the Schedule under which payment for day work is made. One copy of each list and statement will if correct or when agreed be signed by the Engineer's Representative and returned to the Contractor. At the end of each month the Contractor shall deliver to the Engineer's Representative a priced statement of the labour material and plant (except as aforesaid) used and the Contractor shall not be entitled to any payment unless such lists and statements have been fully and punctually rendered. Provided always that if the Engineer shall consider that for any reason the sending of such list or statement by the Contractor in accordance with the foregoing provision was impracticable he shall nevertheless be entitled to authorise payment for such work either as daywork (on being satisfied as to the time employed and plant and materials used on such work) or at such value therefor as he shall consider fair and reasonable.

(iv) The Contractor shall send to the Engineer once in every month an account giving full and detailed particulars of all claims for any additional expense to which the Contractor may consider himself entitled and of all extra or additional work ordered by the Engineer which he has executed during the preceding month and no claim for payment for any such work will be considered which has not been included in such particulars. Provided always that the Engineer shall be entitled to authorise payment to be made for any such work notwithstanding the Contractor's failure to comply with this condition if the Contractor has at the earliest practicable opportunity notified the Engineer that he intends to make a claim for such work.

#### **Property in Materials and Plant.**

53. (i) For the purpose of this Clause: (i) The expression "Constructional Plant" shall be deemed to exclude vehicles engaged in transporting any plant, equipment or materials to or from the Site. (ii) The expression "Essential Hired Plant" shall mean all Constructional Plant, Temporary Works and materials for Temporary Works the withdrawal of which in the event of a forfeiture under Clause 63 hereof might (having regard to the methods of construction employed prior to the forfeiture) endanger the safety or stability of or result in serious disturbance to the execution of any part of the Works and which are held by the Contractor under any agreement for hire thereof. (iii) The expression "Hired Plant" shall mean any Constructional Plant, Temporary Works and materials for Temporary Works (other than Essential Hired Plant) held by the Contractor under any agreement for hire thereof. (iv) The expression "agreement for hire" shall be deemed not to include an agreement for hire purchase. (v) The expression "Hire Purchase Plant" shall mean any Constructional Plant, Temporary Works and materials for Temporary Works held by the Contractor under an agreement for hire purchase thereof.

(2) All Constructional Plant, Temporary Works and materials owned by the Contractor or by any company in which the Contractor has a controlling interest shall when brought on to the Site (or in the case of Hire Purchase Plant on the Site on its becoming the property of the Contractor) immediately be deemed to become the property of the Employer.

(3) With a view to securing in the event of a forfeiture under Clause 63 hereof the continued availability for the purpose of executing the Works of any Essential Hired Plant the Contractor shall not bring on to the Site any Essential Hired Plant unless the agreement for hire thereof contains a provision that the owner thereof will on request in writing made by the Employer within seven days after the date on which any such forfeiture has become effective and on the Employer undertaking to pay all hire charges in respect thereof from such date hire such Essential Hired Plant to the Employer on the same terms in all respects as the same was hired to the Contractor save that the Employer shall be entitled to permit the use thereof by any other con-

tractor employed by him for the purpose of completing the Works under the terms of the said Clause 63

(4) In the event of the Employer entering into any agreement for hire of Essential Hired Plant pursuant to the provisions of sub-clause (3) of this Clause all sums properly paid by the Employer under the provisions of any such agreement and all expenses incurred by him (including stamp duties) in entering into such agreement shall be deemed for the purpose of Clause 63 hereof to be part of the cost of completing the Works.

(5) The Contractor shall upon request made by the Engineer at any time in relation to any item of Essential Hired Plant forthwith notify to the Engineer in writing the name and address of the owner thereof and shall certify that the agreement for the hire thereof contains a provision in accordance with the requirements of sub-clause (3) of this Clause. The Contractor shall also upon request as aforesaid give a like notification (but without certificate) in regard to any Hire Purchase Plant.

(6) The Employer shall in order to avoid seizure by the owner of any Hire Purchase Plant be entitled to pay to such owner the amount of any overdue instalment or other sum payable under any agreement for hire purchase and in the event of his doing so any amount so paid by him shall be a debt due from the Contractor to the Employer and may be deducted by the Employer from any monies due or that may become due to the Contractor under the Contract or may be recovered by the Employer from the Contractor at law

(7) No Constructional Plant Temporary Works or materials or any part thereof (except Hired Plant) shall be removed from the Site without the written consent of the Engineer which consent shall not be unreasonably withheld where the same is no longer immediately required for the purposes of completion of the Works but the Employer will permit the Contractor the exclusive use of all such Constructional Plant Temporary Works and materials in and for the completion of the Works until the occurrence of any event which gives the Employer the right to exclude the Contractor from the Site and proceed with the completion of the Works.

(8) Upon removal of any such Constructional Plant Temporary Works or materials as have been deemed to have become the property of the Employer under sub-clause (2) of this Clause with consent as aforesaid the property therein shall be deemed to revert in the Contractor and upon completion of the Works the property in the remainder of such Constructional Plant Temporary Works and materials as aforesaid shall subject to the provisions of Clause 63(1) hereof be deemed to revert in the Contractor who shall remove the same together with any Essential Hired Plant Hired Plant and Hire Purchase Plant. If the Contractor shall fail to remove any Constructional Plant Temporary Works or materials as aforesaid or any Essential Hired Plant Hired Plant or Hire Purchase Plant within such reasonable time after completion of the Works as may be allowed by the Engineer then the Employer may (i) sell any such Constructional Plant Temporary Works and materials as aforesaid, and (ii) return at the Contractor's expense to the person firm or company from whom any Essential Hired Plant Hired Plant or any Hire Purchase Plant was held by the Contractor such Essential Hired Plant Hired Plant or Hire Purchase Plant and after deducting from any proceeds of sale the costs charges and expenses of and in connection with such sale and of and in connection with return as aforesaid shall pay the balance (if any) to the Contractor but to the extent that the proceeds of any sale are insufficient to meet all such costs charges and expenses the excess shall be a debt due from the Contractor to the Employer and shall be deductible or recoverable by the Employer accordingly as aforesaid.

(9) The Employer shall not at any time be liable for the loss of or injury to any of the Constructional Plant Temporary Works or materials which have been deemed to become the property of the Employer under sub-clause (2) of this Clause save as mentioned in Clauses 20 and 65 hereof.

(10) The Contractor shall when entering into any sub-contract for the execution of any part of the Works incorporate in such sub-contract (by reference or otherwise) the provisions of this Clause in relation to Constructional Plant Temporary Works and materials Essential Hired Plant Hired Plant and Hire Purchase Plant brought on to the Site by the Sub-Contractor.

54. The operation of the last preceding Clause shall not be deemed to imply any approval by the Engineer of the materials or other matters referred to therein nor shall it prevent the rejection of any such materials at any time by the Engineer.

#### **Measurement.**

55. **Quantities.**—The quantities set out in the Bills of Quantities are the estimated quantities of the work but they are not to be taken as the actual and correct quantities of the Works to be executed by the Contractor in fulfilment of his obligations under the Contract.

56. **Works to be Measured.**—The Engineer shall except as otherwise stated ascertain and determine by admeasurement the value in accordance with the Contract of work done. He shall when he requires any part or parts of the Works to be measured give notice to the Contractor who shall forthwith attend or send a qualified agent to assist the Engineer or the Engineer's Representative in making such measurement and shall furnish all particulars required by either of them. Should the Contractor not attend or neglect or omit to send such agent then the measurement made by the Engineer or approved by him shall be taken to be the correct measurement of the work.

57. **Method of Measurement.**—Except where any general or detailed description of the work in the Bill of Quantities expressly shows the contrary Bills of Quantities shall be deemed to have been prepared and measurements shall be made accordingly to the procedure set forth in the Standard Method of Measurement of Civil Engineering Quantities issued by the Institution of Civil Engineers (1953) and any subsequent amendment or modification thereof notwithstanding any general or local custom.

#### **Provisional and Prime Cost Sums and Contingencies.**

58. (1) Every provisional sum (other than P.C. prices under sub-clause (2) of this Clause) set out in the Bill of Quantities (whether for work to be executed by the Contractor which has not been specified in detail when the Contract is entered into or for work to be executed by a nominated Sub-Contractor as hereinafter defined) together with the charges and profits (if any) which the Contractor shall have added to such sums shall be deducted from the Contract Price and in lieu thereof there shall be added to the Contract Price: (a) where work to which the provisional sum relates has been ordered by the Engineer and executed by the Contractor the value of the work so executed valued in accordance with Clause 52 hereof and (b) where work to which the provisional sum relates has been ordered by the Engineer and executed by a nominated Sub-Contractor (as hereinafter defined) the sum or sums actually paid by the Contractor to such Sub-Contractor on the direction of the Engineer and (if the Contractor shall have added to the provisional sum to which the work relates any sums in respect of charges and profits) a sum in the same proportion to the sum so actually paid as the said charges and profits bear to the said provisional sum.

(2) Every sum in the Bill of Quantities which contains (either as the whole or part of the sum) a prime cost (P.C.) price for goods or materials to be supplied for or for incorporation into the Works shall be varied by the substitution for the prime cost price of the actual price paid by the Contractor for the goods or materials on the direction of the Engineer and the Contract Price shall be increased or decreased (as the case may be) by the amount by which the sum in the Bill of Quantities is increased or decreased by such substitution. No variation shall be made to or in respect of any sum added for labours to the prime cost on account of the said actual price being greater or less than the prime cost price but in respect of all other charges and profit there shall be added or deducted as the case may be a sum representing such percentage as is provided in the Bill of Quantities in relation to the particular item of prime cost concerned or (if none) as is inserted by the Contractor in the form of Tender as the percentage for the adjustment of prime cost sums.

(3) All sums set out in the Bill of Quantities which shall be stated to be provisional or for contingencies shall be used only at the direction and discretion of the Engineer and if not used either wholly or in part shall as to the amount not used be deducted from the Contract Price.

(4) The Contractor shall when required by the Engineer produce all quotations invoices vouchers and accounts or receipts in connection with expenditure in respect of provisional or prime cost items.

(5) In so far as any sum is paid by the Contractor to a Sub-Contractor or supplier by direction of the Engineer under sub-clause (1)(b) or (2) of this Clause before the Contractor shall have received payment of that sum from the Employer the Contractor shall be entitled to receive from the Sub-Contractor or supplier a cash discount on the sum so paid not exceeding 2½ per cent. which shall not be deducted in determining the sums actually paid by the Contractor under the said sub-clauses.

(6) In the event of a nominated Sub-Contractor (as hereinafter defined) having undertaken towards the Contractor in respect of the work executed or the goods or materials supplied by such nominated Sub-Contractor any continuing obligation extending for a period exceeding that of the Period of Maintenance under this Contract the Contractor shall at any time after the expiration of the Period of Maintenance assign to the Employer at the Employer's request and cost the benefit of such obligation for the unexpired duration thereof.

**59. Nominated Sub-Contractors.**—All specialists merchants tradesmen and others executing any work or supplying any goods for which provisional or prime cost sums are included in the Bill of Quantities who may have been or be nominated or selected or approved by the Employer or the Engineer and all persons to whom by virtue of the provisions of the Bill of Quantities or Specification the Contractor is required to sub-let any work shall in the execution of such work or the supply of such goods be deemed to be Sub-Contractors employed by the Contractor and are hereinafter referred to as "nominated Sub-Contractors." Provided always that the Contractor shall not be required by the Employer or the Engineer or be deemed to be under any obligation to employ any nominated Sub-Contractor who shall decline to quote to the Contractor subject to discount for cash within such number of days as the nominated Sub-Contractor shall stipulate, or enter into a sub-contract with the Contractor containing provisions:—

- (a) That in respect of the work or goods the subject of the sub-contract the Sub-Contractor will undertake towards the Contractor the like obligations and liabilities as are imposed upon the Contractor towards the Employer by the terms of the Contract and will save harmless and indemnify the Contractor from and against the same and from all claims demands proceedings damages costs charges and expenses whatsoever arising out of or in connection therewith or arising out of or in connection with any failure to perform such obligations or to fulfil such liabilities and
- (b) That the Sub-Contractor will save harmless and indemnify the Contractor from and against any negligence by the Sub-Contractor his agents workmen and servants and from and against any misuse by him or them of any Constructional Plant or Temporary Works provided by the Contractor for the purposes of the Contract and from all claims as aforesaid.

Before issuing under Clause 60 hereof any certificate which includes any payment in respect of work done or goods supplied by any nominated Sub-Contractor the Engineer shall be entitled to demand from the Contractor reasonable proof that all payments (less retentions) included in previous certificates in respect of the work or goods of such nominated Sub-Contractor have been paid or discharged by the Contractor in default whereof unless the Contractor shall

- (a) inform the Engineer in writing that he has reasonable cause for withholding or refusing to make such payment and
- (b) produce to the Engineer reasonable proof that he has so informed such nominated Sub-Contractor in writing

the Employer shall be entitled to pay to such nominated Sub-Contractor direct upon the certificate of the Engineer all payments (less retentions) which the Contractor has failed to make to such nominated Sub-Contractor and to deduct by way of set-off the amount so paid by the Employer from any sums due or which become due from the Employer to the Contractor.

Provided always that where the Engineer has certified and the Employer has paid direct as aforesaid the Engineer shall in issuing any further certificate in favour

of the Contractor deduct from the amount thereof the amount so paid direct as aforesaid but shall not withhold or delay the issue of the certificate itself when due to be issued under the terms of the Contract.

#### **Certificates and Payment.**

60. (i) The Contractor shall submit to the Engineer after the end of each month a statement showing the estimated contract value of the permanent work executed up to the end of the month (if such value shall justify the issue of an interim certificate) and the Contractor will be paid monthly on the certificate of the Engineer the amount due to him on account of the estimated contract value of the permanent work executed up to the end of the previous month together with such amount (if any) as the Engineer may consider proper on account of materials for permanent work delivered by the Contractor on the Site and in addition such amount as the Engineer may consider fair and reasonable for any Temporary Works or Constructional Plant for which separate amounts are provided in the Bill of Quantities subject to a retention of the percentage named in the Tender until the amount retained shall reach the "Limit of Retention Money" named in the Tender (hereinafter called "the retention money"). Provided always that no interim certificate shall be issued for a less sum than that named in the Tender at one time

(ii) One half of the retention money shall become due and shall be paid to the Contractor when the Engineer shall certify in writing that the Works have been substantially completed and the other half shall be paid to the Contractor at the expiration of the Period of Maintenance notwithstanding that at such time there may be outstanding claims by the Contractor against the Employer. Provided always that if at such time there shall remain to be executed by the Contractor any works ordered during such period pursuant to Clauses 49 and 50 hereof the Employer shall be entitled to withhold payment until the completion of such works so much of the second half of the retention money as shall in the opinion of the Engineer represent the cost of the works so remaining to be executed.

Provided further that in the event of different maintenance periods having become applicable to different parts of the works pursuant to Clause 48 hereof the expression "expiration of the Period of Maintenance" shall for the purposes of this sub-clause be deemed to mean the expiration of the latest of such periods.

(iii) Payment upon each of the Engineer's certificates shall be made by the Employer within the number of days named in the Tender after such certificate has been delivered to the Employer and in the event of failure by the Employer to comply with the provisions of this sub-clause or to pay the retention money or any part thereof at the times prescribed by sub-clause (ii) of this Clause he shall pay to the Contractor interest at the rate of 5 per cent. per annum upon all over-due payments from the date on which the same should have been made.

(iv) The Engineer may by any certificate make any correction or modification in any previous certificate which shall have been issued by him and shall have power to withhold any certificate if the Works or any part thereof are not being carried out to his satisfaction.

61. **Approval only by Maintenance Certificate.**—No certificate other than the Maintenance Certificate referred to in Clause 62 hereof shall be deemed to constitute approval of any work or other matter in respect of which it is issued or shall be taken as an admission of the due performance of the Contract or any part thereof or of the accuracy of any claim or demand made by the Contractor or of additional or varied work having been ordered by the Engineer nor shall any other certificate conclude or prejudice any of the powers of the Engineer.

62. **Maintenance Certificate.**—(i) The Contract shall not be considered as completed until a Maintenance Certificate shall have been signed by the Engineer and delivered to the Employer stating that the Works have been completed and maintained to his satisfaction. The Maintenance Certificate shall be given by the Engineer upon the expiration of the Period of Maintenance or as soon thereafter as any works ordered during such period pursuant to Clauses 49 and 50 hereof shall have been completed to the satisfaction of the Engineer and full effect shall be given to this Clause notwithstanding any previous entry on the Works or the taking posses-

sion working or using thereof or any part thereof by the Employer. Provided always that the issue of the Maintenance Certificate shall not be a condition precedent to payment to the Contractor of the second half of the retention money in accordance with Clause 60 hereof.

(ii) The Employer shall not be liable to the Contractor for any matter or thing arising out of or in connection with the Contract or the execution of the Works unless the Contractor shall have made a claim in writing in respect thereof before the giving of the Maintenance Certificate under this Clause.

(iii) Notwithstanding the issue of the Maintenance Certificate the Contractor and (subject to sub-clause (ii) of this Clause) the Employer shall remain liable for the fulfilment of any obligation incurred under the provisions of the Contract prior to the issue of the Maintenance Certificate which remains unperformed at the time such certificate is issued and for the purposes of determining the nature and extent of any such obligation the Contract shall be deemed to remain in force between the parties hereto.

### Remedies and Powers.

**63. Forfeiture.**—(1) If the Contractor shall become bankrupt or have a receiving order made against him or shall present his petition in bankruptcy or shall make an arrangement with or assignment in favour of his creditors or shall agree to carry out the Contract under a committee of inspection of his creditors or (being a corporation) shall go into liquidation (other than a voluntary liquidation for the purposes of amalgamation or reconstruction) or if the Contractor shall assign the Contract without the consent in writing of the Employer first obtained or shall have an execution levied on his goods or if the Engineer shall certify in writing to the Employer that in his opinion the Contractor :—

- (a) has abandoned the Contract or
- (b) without reasonable excuse has failed to commence the Works or has suspended the progress of the Works for 14 days after receiving from the Engineer written notice to proceed or
- (c) has failed to proceed with the Works with due diligence or
- (d) has failed to remove materials from the Site or to pull down and replace work for 14 days after receiving from the Engineer written notice that the said materials or work had been condemned and rejected by the Engineer under these conditions or
- (e) is not executing the Works in accordance with the Contract or is persistently or flagrantly neglecting to carry out his obligations under the Contract or
- (f) has to the detriment of good workmanship or in defiance of the Engineer's instructions to the contrary sub-let any part of the Contract

then the Employer may after giving 7 days' notice in writing to the Contractor enter upon the Site and the Works and expel the Contractor therefrom without thereby avoiding the Contract or releasing the Contractor from any of his obligations or liabilities under the Contract or affecting the rights and powers conferred on the Employer or the Engineer by the Contract and may himself complete the Works or may employ any other contractor to complete the Works and the Employer or such other contractor may use for such completion so much of the Constructional Plant Temporary Works and materials which have been deemed to become the property of the Employer under Clause 53(2) hereof on the Site as he or they may think proper and the Employer may at any time sell any of the said Constructional Plant Temporary Works and unused materials and apply the proceeds of sale in or towards the satisfaction of any sums due or which may become due to him from the Contractor under the Contract

(ii) The Engineer shall as soon as may be practicable after any such entry and expulsion by the Employer fix and determine *ex parte* or by or after reference to the parties or after such investigation or enquiries as he may think fit to make or institute and shall certify what amount (if any) had at the time of such entry and expulsion been reasonably earned by or would reasonably accrue to the Contractor in respect of work then actually done by him under the Contract and what was the value of any unused or partially used materials any Constructional Plant and any Temporary

Works which have been deemed to become the property of the Employer under Clause 53(2) hereof upon the Site.

(iii) If the Employer shall enter and expel the Contractor under this Clause he shall not be liable to pay to the Contractor any money on account of the Contract until the expiration of the Period of Maintenance and thereafter until the costs of completion and maintenance damages for delay in completion (if any) and all other expenses incurred by the Employer have been ascertained and the amount thereof certified by the Engineer. The Contractor shall then be entitled to receive only such sum or sums (if any) as the Engineer may certify would have been due to him upon due completion by him after deducting the said amount. But if such amount shall exceed the sum which would have been payable to the Contractor on due completion by him then the Contractor shall upon demand pay to the Employer the amount of such excess and it shall be deemed a debt due by the Contractor to the Employer and shall be recoverable accordingly.

**64. Urgent Repairs.**—If by reason of any accident or failure or other event occurring to in or in connection with the Works or any part thereof either during the execution of the Works or during the Period of Maintenance any remedial or other work or repair shall in the opinion of the Engineer be urgently necessary for security and the Contractor is unable or unwilling at once to do such work or repair the Employer may by his own or other workmen do such work or repair as the Engineer may consider necessary. If the work or repair so done by the Employer is work which in the opinion of the Engineer the Contractor was liable to do at his own expense under the Contract all costs and charges properly incurred by the Employer in so doing shall on demand be paid by the Contractor to the Employer or may be deducted by the Employer from any monies due or which may become due to the Contractor. Provided always that the Engineer shall as soon after the occurrence of any such emergency as may be reasonably practicable notify the Contractor thereof in writing.

#### War Clause.

**65.** (i) If during the currency of the Contract there shall be an outbreak of war (whether war is declared or not) in which Great Britain shall be engaged on a scale involving general mobilisation of the armed forces of the Crown the Contractor shall for a period of 28 days reckoned from midnight on the date that the order for general mobilisation is given continue so far as is physically possible to execute the Works in accordance with the Contract.

(ii) If at any time before the expiration of the said period of 28 days the Works shall have been completed or completed so far as to be usable all the provisions of the Contract shall continue to have full force and effect save that

(a) the Contractor shall in lieu of fulfilling his obligations under Clauses 49 and 50 hereof be entitled at his option to allow against the sum due to him under the provisions hereof the cost (calculated at the prices ruling at the beginning of the said period of 28 days) as certified by the Engineer at the expiration of the Period of Maintenance of repair rectification and making good any work for the repair rectification or making good of which the Contractor would have been liable under the said Clauses had they continued to be applicable

(b) the Employer shall not be entitled at the expiration of the Period of Maintenance to withhold payment under Clause 60 (ii) hereof of the second half of the retention money or any part thereof except such sum as may be allowable by the Contractor under the provisions of the last preceding paragraph which sum may (without prejudice to any other mode of recovery thereof) be deducted by the Employer from such second half.

(iii) If the Works shall not have been completed as aforesaid the Employer shall be entitled to determine the Contract (with the exception of this Clause and Clauses 66 and 68 hereof) by giving notice in writing to the Contractor at any time after the aforesaid period of 28 days has expired and upon such notice being given the Contract shall (except as above mentioned) forthwith determine but without prejudice to the claims of either party in respect of any antecedent breach thereof.



(iv) If the Contract shall be determined under the provisions of the last preceding sub-clause the Contractor shall with all reasonable despatch remove from the Site all his Constructional Plant and shall give facilities to his Sub-Contractors to remove similarly all Constructional Plant belonging to them and in the event of any failure so to do the Employer shall have the like powers as are contained in Clause 53 (8) hereof in regard to failure to remove Constructional Plant on completion of the Works but subject to the same condition as is contained in Clause 53 (a) hereof.

(v) If the Contract shall be determined as aforesaid the Contractor shall be paid by the Employer (in so far as such amounts or items shall not have been already covered by payment on account made to the Contractor) for all work executed prior to the date of determination at the rates and prices provided in the Contract and in addition:

(a) The amounts payable in respect of any preliminary items so far as the work or service comprised therein has been carried out or performed and a proper proportion as certified by the Engineer of any such items the work or service comprised in which has been partially carried out or performed.

(b) The cost of materials or goods reasonably ordered for the Works or Temporary Works which shall have been delivered to the Contractor or of which the Contractor is legally liable to accept delivery (such materials or goods becoming the property of the Employer upon such payment being made by him).

(c) A sum to be certified by the Engineer being the amount of any expenditure reasonably incurred by the Contractor in the expectation of completing the whole of the Works in so far as such expenditure shall not have been covered by the payments in this sub-clause before mentioned.

(d) Any additional sum payable under the provisions of sub-clause vi (b) (c) and (d) of this Clause.

(e) The reasonable cost of removal under sub-clause (iv) of this Clause.

(vi) Whether the Contract shall be determined under the provisions of sub-clause (in) of this Clause or not the following provisions shall apply or be deemed to have applied as from the date of the said outbreak of war notwithstanding anything expressed in or implied by the other terms of the Contract viz. :-

(a) The Contractor shall be under no liability whatsoever whether by way of indemnity or otherwise for or in respect of damage to the Works or to property (other than property of the Contractor or property hired by him for the purposes of executing the Works) whether of the Employer or of third parties or for or in respect of injury or loss of life to persons which is the consequence whether direct or indirect of war hostilities (whether war has been declared or not) invasion act of the Queen's enemies civil war rebellion revolution insurrection military or usurped power and the Employer shall indemnify the Contractor against all such liabilities and against all claims demands proceedings damages costs charges and expenses whatsoever arising thereout or in connection therewith.

(b) If the Works or Temporary Works or any materials on the Site (whether for the former or the latter) shall sustain destruction or any damage by reason of any of the causes mentioned in the last preceding paragraph the Contractor shall nevertheless be entitled to payment for any permanent work so destroyed or damaged and the Contractor shall be entitled to be paid by the Employer the cost of making good any such destruction or damage whether to permanent work or the Temporary Works so far as may be required by the Engineer or as may be necessary for the completion of the Works on a prime cost basis plus such profit as the Engineer may certify to be reasonable.

(c) If under decision of the Civil Engineering Construction Conciliation Board or of any other body recognised as an appropriate body for regulating the rates of wages in any trade or industry other than the Civil Engineering Construction Industry to which Contractors undertaking works of civil engineering construction give effect by agreement or in practice or by reason of any Statute or Statutory Instrument there shall during the currency of the Contract be any increase or decrease in the wages or the rates of wages or in the allowances or rates of allowances (including allowances in respect of holidays)

payable to or in respect of labour of any kind prevailing at the date of outbreak of war as then fixed by the said Board or such other body as aforesaid or by Statute or Statutory Instrument or any increase in the amount payable by the Contractor by virtue of or in respect of any Scheme of State Insurance or if there shall be any increase or decrease in the cost prevailing at the date of the said outbreak of war of any materials consumable stores fuel or power (and whether for permanent or temporary works) which increase or increases decrease or decreases shall result in an increase or decrease of cost to the Contractor in carrying out the Works the net increase or decrease of cost shall form an addition or deduction as the case may be to or from the Contract Price and be paid to or allowed by the Contractor accordingly.

- (d) If the cost of the Works to the Contractor shall be increased or decreased by reason of the provisions of any Statute or Statutory Instrument or other Government or Local Government Order or Regulation becoming applicable to the Works after the date of the said outbreak of war or by reason of any trade or industrial agreement entered into after such date to which the Civil Engineering Construction Conciliation Board or any other body as aforesaid is party or gives effect or by reason of any amendment of whatsoever nature of the Working Rule Agreement of the said Board or of any other body as aforesaid or by reason of any other circumstance or thing attributable to or consequent on such outbreak of war such increase or decrease of cost as certified by the Engineer shall be reimbursed by the Employer to the Contractor or allowed by the Contractor as the case may be.
- (e) Damage or injury caused by the explosion whenever occurring of any mine bomb shell grenade or other projectile missile or munition of war and whether occurring before or after the cessation of hostilities shall be deemed to be the consequence of any of the events mentioned in sub-clause vi (a) of this Clause.

#### **Frustration.**

**65A.** In the event of the Contract being frustrated whether by war or otherwise howsoever the sum payable by the Employer to the Contractor in respect of the work executed shall be the same as that which would have been payable under Clause 65(5) hereof if the Contract had been determined by the Employer under the provisions of Clause 65 hereof.

#### **Settlement of Disputes.**

**66.** If any dispute or difference of any kind whatsoever shall arise between the Employer or the Engineer and the Contractor in connection with or arising out of the Contract or the carrying out of the Works (whether during the progress of the Works or after their completion and whether before or after the determination abandonment or breach of the Contract) it shall be referred to and settled by the Engineer who shall state his decision in writing and give notice of the same to the Employer and the Contractor. Such decision in respect of every matter so referred shall be final and binding upon the Employer and the Contractor until the completion of the work and shall forthwith be given effect to by the Contractor who shall proceed with the Works with all due diligence whether notice of dissatisfaction is given by him or by the Employer as hereinafter provided or not. If the Engineer shall fail to give such decision for a period of three calendar months after being requested to do so or if either the Employer or the Contractor be dissatisfied with any such decision of the Engineer then and in any such case either the Employer or the Contractor may within three calendar months after receiving notice of such decision or within three calendar months after expiration of the said period of three months (as the case may be) require that the matter shall be referred to an arbitrator to be agreed upon between the parties or failing agreement to be nominated on the application of either party by the President for the time being of the Institution of Civil Engineers and any such reference shall be deemed to be a submission to arbitration within the meaning of the Arbitration Act 1950 or the Arbitration (Scotland) Act 1894 as the case may be or any statutory re-enactment or amendment thereof for the time being in force. Such

arbitrator shall have full power to open up review and revise any decision opinion direction certificate or valuation of the Engineer and neither party shall be limited in the proceedings before such arbitrator to the evidence or arguments put before the Engineer for the purpose of obtaining his decision above referred to. The award of the arbitrator shall be final and binding on the parties. Such reference except as to the withholding by the Engineer of any certificate or the withholding of any portion of the retention money under Clause 60 hereof to which the Contractor claims to be entitled or as to the exercise of the Engineer's power to give a certificate under Clause 63 (1) hereof shall not be opened until after the completion or alleged completion of the Works unless with the written consent of the Employer and the Contractor. Provided always (i) that the giving of a Certificate of Completion under Clause 48 hereof shall not be a condition precedent to the opening of any such reference (ii) that no decision given by the Engineer in accordance with the foregoing provisions shall disqualify him from being called as a witness and giving evidence before the arbitrator on any matter whatsoever relevant to the dispute or difference so referred to the arbitrator as aforesaid.

#### **Application to Scotland.**

**67.** If the Works are situated in Scotland the Contract shall in all respects be construed and operate as a Scottish Contract and shall be interpreted in accordance with Scots law.

#### **Notices.**

**68.** Any notice to be given to the Contractor under the terms of the Contract shall be served by sending the same by post to or leaving the same at the Contractor's principal place of business (or in the event of the Contractor being a Company to or at its registered office).

Any notice to be given to the Employer under the terms of the Contract shall be served by sending the same by post to or leaving the same at the Employer's last known address (or in the event of the Employer being a Company to or at its registered office).

## APPENDIX II

### SPECIFICATION FOR A TYPICAL BRIDGE CONTRACT

THIS specification is based on an actual contract. Thus some of the clauses would require amendment or would be redundant on another contract, for which additional clauses might be required. Reference should be made also to the Ministry of Transport Specification for Road and Bridge Works.

### SPECIFICATION OF WORKS FOR THE CONSTRUCTION OF A BRIDGE OVER THE RIVER ..... AND CONTINGENT WORKS.

#### Preamble.

1. DESCRIPTION OF WORKS.—The contract embraces the construction of a new bridge over the river ..... at ..... in the County of ..... and includes the diversion of the existing road. The total length of the new bridge and the approach works will be about 1200 ft. and will be on a gradient of approximately 1 in 125. The site of the new bridge is about 240 ft. downstream from the existing bridge at .....

The new approach road will diverge from the existing main road a short distance from the existing railway bridge and will take the form of a reverse curve across the river to rejoin the existing main road at a point 350 ft. beyond the existing premises of Messrs. A. & B., as shown on the site plan. The radii of the curves of the new road will be 300 ft. and 640 ft., with suitable spiral transition curves at both ends of each circular arc. The new road, which will have a carriageway 26 ft. wide and two 7-ft. footpaths, will be laid on filling contained between new reinforced concrete retaining walls, except for a portion of the north approach which will be on a new low embankment.

The new bridge, which will be on a curve on plan, will be a reinforced concrete vaulted arch structure with a single span of approximately 100 ft. For a distance of 15 ft. on either side of the crown the road will be laid on filling deposited between spandrel walls. For the remainder of the span a reinforced concrete deck will be supported on transverse walls built off the arch slab. At the abutments, reinforced concrete retaining walls will contain the filling upon which the road will be laid.

The existing bridge will remain in use for pedestrians, and road blocks will be constructed after completion of the new works.

2. AVAILABLE SPACE.—Only the land within the boundaries of the Works is available for the use of the Employer for the purposes of the contract. If the contractor requires additional area for stores or offices or for carrying out operations connected with the contract he shall make his own arrangements for leasing or otherwise acquiring such additional working space, and shall be deemed to have included the cost thereof in his tender.

3. MAINTENANCE OF TRAFFIC.—During the whole of the time the Works are in progress road and pedestrian traffic shall be maintained along the existing road and over the existing bridge with a minimum of interference. Any system of traffic signalling deemed necessary by the Engineer shall be installed, maintained, operated, and ultimately removed by the Contractor. The Contractor shall erect, maintain, and remove such barricades, direction signs, and lighting in connection therewith for the protection of pedestrians and other users of the existing road as may be deemed necessary by the Engineer.

4. **PROTECTION OF GAME AND TREES.**—Care shall be taken to prevent damage from any cause whatsoever to fish or game, and the Contractor shall be held liable for any such damage whether caused by him or by his employees or in any way directly or indirectly resulting from the execution of the Works.

Throughout the progress of the Works care shall be taken to avoid damage to trees and bushes and to preserve the natural scenery, outside the boundaries of the Works as delineated on the site plan.

5. **WATER LEVELS.**—The Contractor shall by his own enquiry and observation determine the normal level of the water in the river, the levels of high and low water at mean spring tides, and the level of floods possible during the course of the contract. The Contractor shall be deemed to have included in his tender for all contingencies due to variations in the water level.

The levels and depths of water and subsoil and the tide ranges shown on the drawings are not guaranteed and the Contractor shall provide, maintain, and remove upon completion temporary works sufficient to protect the Works and to enable the Works to proceed to the satisfaction of the Engineer during all states of the water-level in the river. The Contractor shall, subject to the provisions of Clauses 20, 21, and 22 of the Conditions of Contract, at his own expense make good any damage to the Works by floods, blow-outs, or any other cause.

6. **OFFICE FOR ENGINEER'S REPRESENTATIVE**—The Contractor shall provide, furnish, maintain, heat, light, and remove upon completion of the Works a suitable office for the Engineer's representative.

### **Materials.**

7. **GENERAL.**—The materials used in the Works shall be new and of the qualities and kinds specified, and no material shall be used in the Works until approved.

Materials delivered to the Works shall be equal to the approved samples. Delivery shall be made sufficiently in advance of constructional requirements to enable further samples to be selected and tested by the Engineer before using the materials in the Works.

Materials failing to comply with the Specification shall be immediately removed from the Works at the Contractor's expense.

8. **SAMPLES AND TESTS.**—Samples of or certificates for the reinforcement, cement, fine aggregate, coarse aggregate, and such other materials as specified or directed, shall be deposited with the Engineer as soon as possible after the commencement of the Works and before delivery of the materials represented thereby. Samples of cement and aggregate shall be deposited with the Engineer at least thirty-five days prior to the use of these materials in the Works.

If during the course of the Works the source or type of any material be changed, further samples shall be deposited with the Engineer and approval obtained before delivery of the material concerned.

Irrespective of any contrary requirements specified other than in this Specification, the requirements hereinafter specified shall apply to samples and tests of materials and to the cost of such samples and tests. Samples or test pieces of materials if specified herein or instructed to be supplied by the Contractor shall be so supplied, prepared, and delivered at the Contractor's own cost. The cost of all tests specified herein or instructed to be made shall be paid by the Contractor, who shall be reimbursed for the cost of tests on such materials as comply in all respects with this Specification.

Certificates and similar documents specified herein or instructed to be supplied by the Contractor to the Engineer shall be so supplied at the Contractor's expense and the Contractor shall make or have made at his own expense all tests necessary to obtain the information specified to be given on the certificates or similar documents.

9. **PROTECTION OF MATERIALS.**—Materials shall be transported, handled, and stored on the site in such a manner as to prevent damage, deterioration, or contamination. Reinforcement shall be stored under cover clear of the ground. Cement shall be stored in a dry watertight shed the floor of which shall be raised clear of the ground. Aggregates shall be stored in a bin or on a clean hard surface and

maintained free from loam, vegetable matter, dust, or other contamination. Aggregates of different types or sizes shall be kept separate.

10. REINFORCEMENT.—The reinforcement shall be plain round bars of mild steel and shall comply with British Standard No. 785.

All reinforcement shall be free from pitting, loose rust, mill scale, paint, oil, grease, adhering earth, ice, or any other material that in the opinion of the Engineer may impair the bond between the concrete and the reinforcement or that causes corrosion of the reinforcement or disintegration of the concrete. Adhering cement grout shall be approved.

Each consignment of reinforcement for use in the Works shall be accompanied by a certificate giving the ultimate strength, yield point, and elongation, and the result of the cold-bend test for each size of bar included in the consignment. All tests for the purpose of obtaining the information on these certificates shall comply with the procedure described in B.S. No. 785.

If any reinforcement be supplied from the Contractor's or other stock for which mill test sheets or other records are not available, or where in the Engineer's opinion the material has been subject to corrosion or other deleterious influences, the Engineer shall select as many test pieces from such bars as he may deem necessary. The Contractor shall obtain, deliver, prepare, and test the test pieces at his own expense and shall have no claim for bars mutilated in obtaining the test pieces.

The preparation of the test pieces and the test procedure shall comply with the requirements of B.S. No. 785.

The size of a reinforcement bar described on the drawings or elsewhere shall be the minimum size, and the rolling margin and other tolerances shall be wholly above this size. The length of a reinforcement bar shall be not less than the length of that bar as described on the drawing or elsewhere and shall be not more than 2 in. in excess of that length.

11. CEMENT.—The cement shall be of approved manufacture and shall be normal-setting ordinary Portland complying with British Standard No. 12. If the Contractor is directed to use rapid-hardening Portland cement it shall comply with the requirements for this type of cement in British Standard No. 12. If the Contractor is directed to use high-alumina cement it shall comply with British Standard No. 915. Quick-setting cements shall not be used. Cements of different types shall not be mixed one with another. All cement shall be fresh when delivered.

Consignments shall be used in the order in which they are delivered. Each consignment shall be identifiable, and the Contractor shall supply the Engineer with a copy of the manufacturer's test certificate for each consignment. The compression test on cement-sand cubes specified in the appropriate British Standard shall be made for all types of cement. The tensile test on cement-sand briquettes shall not be made. If the Engineer deems it necessary to make further tests on any of the cement used in the Works, samples shall be taken as instructed from the manufacturer's bin or other stores, or from the site store, or from elsewhere on the Works, or from any place where cement be used for incorporation in the Works. The selection of the samples and the procedure of the tests shall comply with the appropriate British Standard.

12. ADMIXTURES.—Admixtures for accelerating initial setting of the cement or for increasing the impermeability or workability of the concrete or for any other purpose shall be used only if approved. The Contractor shall supply the Engineer with the description, trade name and, where possible, the chemical composition of the proposed admixture, and if instructed shall supply approved evidence that the proposed admixture has been satisfactorily used elsewhere for the identical purpose for which it is intended to be used in the Works. Admixtures or other materials that retard the setting of the cement shall not be used.

13. CONCRETE AGGREGATES.—Materials used as aggregate for plain or reinforced concrete shall where possible be derived from a source that normally produces aggregate satisfactory for concrete and, if requested by the Engineer, the Contractor shall supply evidence to this effect. If instructed, samples of the aggregate shall be supplied for the purpose of making preliminary concrete test cubes as hereinafter specified.

Aggregates shall be chemically inert, strong, hard, durable, of limited porosity, free from adherent coatings, clay lumps, coal, and coal residues, and shall contain no organic or other admixtures that may in the opinion of the Engineer cause corrosion of the reinforcement or impair the strength or durability of the concrete.

If the Engineer so directs, tests of the aggregates shall be made. The samples selected by the Engineer shall be delivered to a prescribed laboratory and tested in compliance with the respective procedures specified in British Standard No. 882. The test results of approved aggregates shall be as hereinafter specified, relative and limiting quantities being deemed to be percentages by weight unless the context otherwise implies.

14. FINE AGGREGATE.—The fine aggregate for plain or reinforced concrete, except the precast blocks and coping of the parapet, shall be natural sand or sand derived by crushing suitable gravel or stone and shall be free from coagulated lumps. Sand derived from a stone unsuitable for coarse aggregate shall not be used as fine aggregate. The caustic soda test for organic impurities shall show a colour not deeper than that of the standard solution (corresponding to Pilkington's  $\frac{3}{8}$  in. deep amber polished plate glass).

The amount of fines ascertained by the laboratory sedimentation test shall not exceed 5 per cent. for natural sand or crushed gravel and shall not exceed 10 per cent. for crushed stone. If instructed a settling test for natural sand or crushed gravel shall be accepted in place of the laboratory sedimentation test. The settling test shall be made by placing a sample of the fine aggregate in clean water in a parallel-sided glass container. After vigorously shaking the mixture, the contents shall be allowed to settle for three hours when the thickness of the layer of silt deposited on the coarser material shall not exceed 10 per cent. of the latter.

The grading of natural sand or crushed gravel fine aggregate shall be such that not more than 5 per cent. shall exceed  $\frac{3}{8}$  in. in size and not more than 10 per cent. shall pass a No. 100 B.S. sieve. The intermediate grading shall be such that not less than 45 per cent. nor more than 85 per cent. shall pass a No. 14 B.S. sieve, and not less than 25 per cent. nor more than 60 per cent. shall pass a No. 25 B.S. sieve.

For plain concrete the grading of fine aggregate from any approved source shall be such that not more than 10 per cent. shall exceed  $\frac{3}{8}$  in. in size and not more than 15 per cent. shall pass a No. 100 B.S. sieve; not less than 25 per cent. shall pass a No. 14 B.S. sieve and not less than 10 per cent. shall pass a No. 25 B.S. sieve.

The aggregate for the precast parapet blocks and coping slabs is to be an approved proprietary mixture containing broken glass or other suitable material to produce a glittering surface.

15. COARSE AGGREGATE.—The coarse aggregate shall be crushed stone or gravel unless specified to the contrary hereinafter. The pieces of aggregate shall be cubical or angular in shape and shall have granular or crystalline or smooth (but not glassy) non-powdery surfaces. Friable, flaky, and laminated pieces, mica, and shale shall only be present in such quantities as not to affect adversely the strength and durability of the concrete as ascertained by tests on concrete cubes.

The strength of the coarse aggregate shall be such that the "aggregate crushing value" defined in B.S. No. 882 shall not exceed 45 per cent. The amount of fines occurring in a free state or as a loose adherent shall not exceed 1 per cent. when tested by the laboratory sedimentation method. After twenty-four hours' immersion in water, a previously dried sample of the coarse aggregate shall not gain in weight more than 5 per cent.

The grading of coarse aggregate shall be such that not more than 5 per cent. shall be larger than the maximum size and not more than 10 per cent. shall be smaller than  $\frac{3}{8}$  in. Between these sizes the coarse aggregate shall be well graded. For all the concrete except the precast kerbs, flags, parapet blocks, and coping slabs the aggregate shall be  $\frac{3}{4}$  in. maximum size and not less than 25 per cent. nor more than 55 per cent. by weight shall be smaller than  $\frac{1}{2}$  in. For the precast parapet blocks and coping slabs the coarse aggregate shall be  $\frac{3}{4}$  in. maximum size and well graded down to  $\frac{1}{4}$  in.

If aggregates conforming to the hereinbefore specified gradings are not reasonably

obtainable, the Contractor shall supply two or more classes of otherwise satisfactory aggregates but of different maximum size and these separate materials shall be mixed in proportions to be directed by the Engineer without any extra charge to the Contract.

The aggregate to be used in the exposed parts of the abutments, spandrel walls, and approach retaining walls and in the precast kerbs, paving slabs, parapet blocks, and coping slabs shall be washed pink Aberdeen granite chippings. Samples of the aggregate used in precast units shall be submitted to and approved by the Engineer before manufacture proceeds.

16. WATER.—The water used for making concrete or mortar, cleaning out shuttering, curing concrete, or similar purposes shall be clean and fresh and free from acid, oil, pollution from industrial or farmyard waste, or other organic or inorganic matter in solution or suspension in such amounts to impair the strength or durability of the concrete or mortar. Water shall be obtained from the public supply, and no water taken from a spring, well, river, lake or similar source or from the estuary or from the excavations shall be used for any purpose on the Works unless approved by the Engineer. If instructed, samples of water collected in an approved manner shall be submitted for the purpose of analysis or for making concrete tests.

17. PRECAST CONCRETE PAVING FLAGS.—The paving flags for the footpaths on the bridge shall be precast natural colour concrete flags of nominal sizes 3 ft. by 2 ft. by 2 in. thick, or of such other dimensions as directed. A certificate shall be furnished stating that the flags delivered comply with the requirements of B.S. No. 368.

18. PRECAST CONCRETE KERBS.—The kerbs for the road throughout shall be natural colour precast concrete kerbs complying with B.S. No. 340 and a certificate shall be furnished stating that the kerbs delivered do so comply. The coarse aggregate shall be crushed granite and samples shall be submitted to the Engineer before the manufacture of the kerbs proceeds. The dimensions of the kerbs shall be 6 in. by 12 in. overall and the section shall be half-battered. Radius kerbs shall be manufactured to the radius shown on the drawings and elsewhere.

19. PILE FITMENTS.—The pile shoes shall be rock shoe type of approved pattern and manufacture weighing not less than 200 lb. each, and shall have chilled-hardened cast-iron bases, special hard wrought-steel points, and mild steel straps. Forks for retaining the longitudinal reinforcement bars in position shall be of cast iron, pressed steel, or other approved metal and of approved shape and length.

20. FILLING MATERIAL.—The filling between the retaining walls, behind the abutments, in the embankment, and between the spandrel walls of the bridge shall be approved before and after depositing. The material shall be capable of being in suitable material from the excavations, the Contractor shall supply additional earth or other approved filling from an approved source. Each load of filling shall be approved before and after depositing. The material shall be capable of being readily consolidated and shall not contain metallic or other rubbish or any substances the decay of which may affect the compactness of the consolidated filling. Clay or earth with a predominating clay content, or soft chalk, shall not be used.

21. PITCHING AND BLINDING FOR ROAD FOUNDATION.—The material for the bottom course of the road foundation shall consist of hard sound blocks of whinstone from an approved quarry, each block being about 9 in. high on a base of area not less than 36 sq. in. and not more than 144 sq. in. The blinding to the bottom course shall consist of quarry slivers of the same material or material of the same nature as the existing road metal, with an approved proportion of clean engine ashes.

22. BITUMINOUS MACADAM.—The material for the bottom layer of the surfacing of the approach roads shall consist of an approved roadstone not exceeding 2 in. in size and graded down to  $\frac{1}{2}$  in. The stone shall be coated with an approved liquid bitumen in the proportion of 9 gallons of bitumen to 1 ton of stone.

The bituminous macadam for the top layer of the surfacing of the approach roads shall be similar to that specified hereinbefore for the bottom layer, except that the stone shall not exceed  $1\frac{1}{4}$  in. in size and shall be graded down to  $\frac{3}{8}$  in.

The bituminous macadam for surfacing the footpaths of the approaches shall conform to the foregoing except that the stone shall be graded from  $\frac{3}{4}$  in. to  $\frac{1}{2}$  in.



23. ASPHALT FOR ROAD SURFACE.—The surface of the road over the bridge shall be a single coat of hot-process rolled asphalt complying with the appropriate parts of B.S. No. 595 subject to the following requirements.

The asphaltic cement shall conform to Table 1, column 1, of B.S. No. 595 and shall have a penetration index of 45 at 77 deg. F. The chippings shall be coated clean hard granite from an approved quarry. Samples of the mixture shall be taken for testing before laying.

The stone, sand, filler, mixing, and the composition of the mixture shall be in accordance with Part 6 of B.S. No. 595 subject to the following provisions. Granite or other igneous rock shall be provided for the stone aggregate and ordinary Portland cement shall be used for the filler. The composition of the mixture shall conform to Table 5, Schedule 3, of B.S. No. 595.

24. GRASS SEED.—The seed for sowing the slopes of the embankments and the margins and verges shall be tested seed composed of a mixture of equal parts of rye grass and white clover and shall be obtained from an approved seedsman.

25. FENCING.—Fencing shall be of the post and wire type, consisting of Douglas pine posts 4 in. square and 6 ft. 6 in. long. The posts shall be creosoted under pressure and for a distance of 3 ft. from the lower end the surface shall be charred and coated with tar. The wire shall be No. 8 gauge best galvanised iron wire. One strand of barbed wire shall be fixed to the inner face of the post and five strands of galvanised iron wire to the outer face. The height from ground level to the top strand shall be 4 ft. The straining posts shall be of Douglas pine 7 in. in diameter and 7 ft. long creosoted under pressure, and the lower half shall be charred and tarred. Corner posts shall comply with the requirements for straining posts and shall be provided with diagonal rakers to be approved by the Engineer. The fencing shall be supplied complete with strainers, ratchet winders, staples, and all other fittings in galvanised metal or other approved non-corrosive material.

### Workmanship.

26. CLEARING THE SITE.—Trees on the site of the Works remain the property of the Estate. Any tree within the boundaries of the Works that may be in the way of the latter shall, unless the Local Authority has issued an order for its preservation, be marked and, upon approval by the Estate, shall be felled, cut into sizes required by the Estate, and loaded on to the Estate's lorries or otherwise disposed of as directed. Roots of trees and bushes shall be grubbed up. Roots and brushwood shall be burned or otherwise disposed of as directed.

The whole area covered by the Works shall be stripped of turf which shall be set aside and properly stacked for re-use if required. Turf not required for re-use shall be disposed of by the Contractor.

The beach shall be cleared of boulders and all loose material and debris.

27. EXCAVATION.—When the site has been cleared as specified hereinbefore and before the main excavation commences the whole area of the Works shall be stripped to a depth of 6 in. of vegetable soil, which shall be deposited in heaps where directed for re-use if required on slopes and verges. Soil unsuitable for re-use shall be disposed of by the Contractor.

Excavations shall be of the width and length necessary for the construction of the foundations and shall be taken out to the depths shown on the drawings or to such depths as directed by the Engineer. The Contractor shall record on a plan the depth of every excavation, which plan, when complete, shall be deposited with the Engineer.

Any obstacle encountered during the excavation shall be reported to the Engineer and shall be dealt with as instructed. The Contractor shall supply and maintain and remove any timbering, sheet-piling, cofferdams, or other temporary works necessary for the retention of the faces of the excavation, and shall by pumping or other approved means maintain the excavations free from water during the construction of the work therein. The term "timbering" shall mean all planking, strutting, sheet-piling, wedges, dogs, straps, bolts, spikes, rails, and other fastenings and fittings whatsoever and of any material. No payment shall be made to the

Contractor for timbering left in position unless so left in by instruction from the Engineer. Should any slips occur, the cavities shall be filled with concrete, dry stone, or other materials as directed by the Engineer and at the Contractor's expense. Any sumps dug in the bottom of the excavation shall be filled in the same way.

Excavations shall be left open for as short a period as possible. Immediately before any work proceeds within an excavation, the sides of the latter shall be trimmed if necessary, and the last 4 in. of the bottom shall be excavated and the whole approved by the Engineer. Where so directed, the Contractor shall excavate a pit or sink a bore hole to ascertain the nature of the sub-strata.

Earth and other materials taken from the excavation shall be set aside for selection for re-use as filling, and material unsuitable for this purpose shall be disposed of by the Contractor. Should any of this suitable surplus material be lost by being deposited in the river or by being washed away by floods or by any other cause, the Contractor shall replace it with an equal quantity of other approved material at his own expense.

28. **ROCK EXCAVATION.**—For the purpose of this Contract, rock shall be only that material which in the Engineer's opinion cannot be broken up and removed by pick and shovel. Incidental boulders occurring within the limits of material not classified hereby as rock shall be considered as rock only if they exceed 2 cu. ft. in capacity.

29. **COFFERDAMS.**—The Contractor shall provide and maintain cofferdams of approved construction for the whole of the retaining walls and the abutments. The cofferdams shall be watertight and shall extend into a trench cut in the rock and shall be staunched by clay or other material. Any fissures in the rock shall be effectively sealed by grouting or otherwise. The cofferdams shall be maintained clear of water by pumping or otherwise during the construction of the work for the period specified, and shall be entirely removed upon completion of the work. Sumps, sluice gates, and all other devices and works necessary for the complete dewatering of the excavations during the construction period shall be provided.

The foundations of the retaining walls and the retaining walls shall be constructed in the dry within the cofferdams and, if the Contractor so desires, in short lengths in the order directed by the Engineer, thereby enabling repeated uses of the cofferdam material. The cofferdams for the abutments shall completely surround each abutment to enable the construction of an entire abutment to proceed continuously.

30. **DRAIN TRENCHES AND PIPE-LAYING.**—Trenches for drains shall be excavated to the lines, levels, and widths shown on the drawings or elsewhere. The bottom of the trenches shall be so cut that each pipe bears on solid undisturbed ground throughout its entire length. Soft or yielding material shall be dug out and replaced by dry and firm material well rammed into place. The trenches shall be maintained free from water while the pipes are being laid. Precautions shall be taken by plugging or otherwise to prevent any material or water getting into the pipes while they are being laid, and no pipes shall be laid until the trench bottom has been prepared to take the pipes for a distance of at least 10 yd. in advance. Upon completion of each section, the pipes shall be flushed out with clean water.

The drain trenches shall be refilled where directed with hand-packed, selected, and approved stone rubble. Elsewhere the trenches shall be filled to their entire depth with approved excavated material deposited in layers not exceeding 12 in. thick. Each layer shall be thoroughly consolidated, and care shall be taken to ensure that no stone is in contact with the pipes or that the pipes are not damaged or displaced during the consolidation of the filling. Surplus material from the trench excavation shall be disposed of on the site as directed.

31. **CONCRETE BLINDING.**—Immediately after the bottom 4 in. of excavation has been removed as hereinbefore specified, the entire area of the bottom of the excavation shall be blinded with a layer of concrete quality D and of the thickness described in the Bills of Quantities. The concrete shall be as dry as practicable, and shall be well tamped into the ground. Where plain concrete is to be deposited on the blinding layer the surface of the latter shall be left roughly grooved. Where reinforced concrete is to be constructed thereon the surface of the blinding layer

shall be spade-finished and the specified cover of concrete under the reinforcement shall be provided entirely above the blinding layer.

32. **BENDING REINFORCEMENT.**—Reinforcement bars shall be bent by machine or other approved means producing a gradual and even motion. Bars shall be bent cold unless the Engineer shall approve bars of over 1 in. in diameter being bent hot. Bars bent hot shall not be heated beyond cherry-red colour, and after bending shall be allowed to cool slowly without quenching.

Bars incorrectly bent shall only be used if the means adopted for straightening and rebending be such as shall not injure the material. Without approval no reinforcement shall be bent when in position in the Works whether or not partially embedded in hardened concrete.

Bends shall comply with the dimensions described in the bending schedules or elsewhere. Overall dimensions shall not be exceeded and shall not be less than  $\frac{1}{4}$  in. below the required dimension. The sizes of binders and the like shall be within a tolerance of  $\frac{1}{4}$  in. under or over the specified dimensions. Any tolerance in the total length of the bar as cut shall be taken up in the end hooks or other approved portions of the bar. Any discrepancies found by the Contractor in the bending schedules, on the drawings, or in other documents shall be immediately reported to the Engineer whose interpretation and instructions relating thereto shall be accepted.

The internal radius of a bend shall be not less than twice the diameter of the bar nor less than the radius given on the bending schedule or elsewhere. A hook and other end anchorage shall be bent to an internal radius of twice the diameter of the bar. The internal radius of the bends at corners of binders and the like shall equal half the diameter of the bar embraced by the binder.

33. **FIXING REINFORCEMENT.**—Reinforcement shall be accurately fixed and by approved means maintained in the position shown on the drawings or elsewhere. Bars intended to be in contact where passing each other shall be securely wired together at such points with No. 16 gauge annealed soft iron tying wire. Binders and the like shall tightly embrace the bars with which they are intended to be in contact and shall be securely wired, or if approved spot-welded, thereto. The ends of the tying wire shall be bent into the body of the work and not left projecting towards the surface of the concrete.

Reinforcement shall be lapped, joined, or spliced only where shown on the drawings or elsewhere. If splices and the like are necessary elsewhere they shall be formed only as directed by the Engineer.

Where practicable bars for each member shall be assembled and fixed in the form of a rigid cage before placing in the moulds or shuttering.

Immediately before concreting, the reinforcement should be checked for position, cleanliness, freedom from rust, or retarding liquid. Means shall be taken to ensure that reinforcement remains correctly in position during the placing and consolidation of the concrete.

Reinforcement projecting from work being concreted or already concreted shall not be bent out of its correct position unless so approved and shall be protected from deformation or other damage.

34. **COVER OF CONCRETE.**—Unless otherwise described elsewhere, the cover of concrete over the reinforcement bars shall be as follows:

Horizontal, vertical, or inclined slabs, walls, arch slab, etc.—1 in. or the size of the bar, whichever is greater.

Beams, columns, piles, etc.: Main bars— $1\frac{1}{2}$  in. or the size of the main bars, whichever is greater. Binders and the like 1 in. minimum.

The specified cover shall be provided and maintained within a tolerance  $\frac{1}{4}$  in. under or over (except where specified as a minimum), by means of accurately made cement mortar or other approved non-corrosive distance pieces.

35. **SPACING OF BARS.**—The minimum clear horizontal distance between adjacent main bars in any one layer in beams or similar shall be 1 in. or the diameter of the bar, whichever is greater. The minimum clear vertical distances between successive layers of main bars in beams or similar shall be  $\frac{1}{2}$  in. for bars not exceeding 1 in. diameter and  $\frac{3}{4}$  in. for bars exceeding 1 in. diameter. These vertical clearances

shall be maintained by the provision of  $\frac{1}{4}$ -in. or  $\frac{3}{8}$ -in. diameter mild steel spacer bars inserted at such intervals that the main bars do not perceptibly sag between adjacent spacer bars.

36. CONSTRUCTION OF SHUTTERING AND CENTERING.—Shuttering, moulds, and centering for concrete shall be substantially and rigidly constructed of timber or steel or pre-cast concrete or other approved material and shall be true to the shape and dimensions shown on the drawings.

Timber shall be well seasoned, free from loose knots and, for shuttering of exposed concrete faces, wrought on all faces. Faces in contact with concrete shall be free from adhering grout, projecting nails, splits, or other defects that will mar the concrete surface. Shuttering for foundations and other concealed work shall be of undressed timber.

All joints, except as hereinbelow specified, shall be sufficiently tight to prevent leakage of cement grout and to avoid the formation of fins or other blemishes, and all faulty joints shall be caulked. If timber boarding be continuously wet throughout the period of use the joints shall be not tight when the shuttering be first constructed. Where the appearance of the concrete face is important, the position and direction of the joints shall be as directed.

Unless described on the drawings or elsewhere to the contrary, fillet strips shall be fixed in the shuttering to form a chamfer 1 in. by 1 in. on all external corners of the concrete whether or not such chamfers be shown on the drawings.

Openings for inspection of the inside of the shuttering for walls, beams and similar work and for the escape of wash-water shall be formed in such a way that they can be conveniently closed before commencing to place the concrete.

Connections shall be constructed to permit of easy removal of the shuttering and shall be either nailed, screwed, bolted, clamped, braced, or otherwise secured so as to be sufficiently strong to retain the correct shape during consolidation of the concrete by tamping, ramming, vibration, or other means. Wire ties shall not be used. Bolt holes in the concrete shall be made good by plugging with cement after the removal of the bolts.

Top shuttering shall be provided to concrete faces where the slope exceeds 1 in 2 $\frac{1}{2}$ . Such shuttering shall be counterweighted or otherwise anchored against floating.

37. ERECTION OF SHUTTERING FOR CONCRETE CAST IN SITU.—Shuttering shall be erected true to line and braced and strutted to prevent deformation under the weight and pressure of the wet concrete, construction loads, wind pressure, or other forces. The deflection shall not exceed  $\frac{1}{8}$  in. Beam soffits shall be erected with an upward camber of  $\frac{1}{4}$  in. for each 10 ft. of horizontal span. If so directed calculations and designs of the shuttering and centering shall be submitted to the Engineer for approval before construction, but irrespective of such approval the Contractor shall be held responsible for the sufficiency and strength of the shuttering, centering, and all other falsework.

Beam and slab shuttering shall be so erected that the shuttering on beam sides and slab soffits can be removed without disturbing the beam bottom boards. Re-propping of beams shall not be approved except when props are reinstated to relieve the beams of loads in excess of the design load as hereinafter specified. Vertical props shall be supported on folding wedges on sole-plates, or other measures shall be taken whereby the props can be gently lowered vertically when commencing to remove the shuttering.

38. ARCH CENTERING.—The centering for the arch slab shall be true to line and sufficiently rigid to prevent settlement or distortion or vibration during the placing and maturing of the concrete, and shall be provided with adequate foundations. Approved provision shall be made for gently easing the centering and shuttering attached thereto away from the concrete before dismantling the centering. The boards forming the shuttering to the soffit of the arch shall be new, dressed, and thickened, and shall be coated with an approved mould oil as hereinafter specified.

Details of the proposed construction of the centering shall be submitted to the Engineer as hereinbefore provided.

39. MOULDS FOR PRECAST CONCRETE.—The moulds for pre-cast piles, parapet

blocks, and coping slabs shall be of such dimensions and construction and with such bracings as to maintain the correct shape and produce clean finished units free from bowing or winding or other distortions. The sides of the moulds shall be so bedded that cement grout shall not leak from under the sides.

40. FIXINGS AND CAVITIES.—No holes or other cavities shall be cut in any concrete work unless approved. The Contractor shall ascertain from the drawings or from sub-contractors or from elsewhere particulars of all bolts and other fixings, and of all openings, holes, pockets, chases, recesses, and other cavities, so that before placing the concrete all bolts and fixings shall be in position, and the cores, gas-pipe, or other approved ferrules, or any other inserts necessary for forming all holes and other cavities, shall be fixed to the shuttering.

41. COATINGS FOR SHUTTERING AND MOULDS.—All faces of shuttering and moulds in contact with wet concrete shall be treated with mould oil or other approved coating to prevent adherence of the concrete. Such coatings shall be insoluble in water, non-staining, and not injurious to the concrete, and shall not become flaky nor be removable by rain or wash water. Liquids that retard the setting of cement shall only be applied to the shuttering when approved. Mould oils, retarding liquids, and similar coatings shall be kept from contact with the reinforcement.

42. PROPORTIONS OF CONCRETE.—The aggregate shall be measured by volume in a gauge box of correct and approved size, or by other approved accurate means. The gauge box or other container shall be filled, without compacting, with the aggregate to a predetermined uniform depth, accurate allowance being made for bulking due to the moisture content of the fine aggregate.

The cement shall be measured by weight, one or more complete bags containing 112 lb. of cement being used for a single batch of concrete.

The nominal proportions of cement and aggregate shall comply with the quantities specified in *Table A* for the respective mix described for each part of the work. The specified quantities shall be altered if so directed after examination of the aggregate in samples or in bulk in order to obtain the densest concrete with approved materials. Any such alterations within the range of 1 part of fine aggregate to 1½ parts of coarse aggregate and 1 part of fine aggregate to 2½ parts of coarse aggregate shall be made without any alteration in the contract rates.

TABLE A.  
CONCRETE.

| Quality | Nominal volumetric proportions | Nominal quantities |  |                            | Crushing strength of site-made cubes, at 28 days (lb per sq in) |
|---------|--------------------------------|--------------------|--|----------------------------|---|
|         |                                | Cement (lb.)       | Fine aggregate (cu. ft. of dry material) | Coarse aggregate (cu. ft.) |   |
| A       | 1 : 2 : 3                      | 112                | 2½                                       | 3½                         | 3,150   |
| B       | 1 : 1½ : 3                     | 112                | 1¾                                       | 3½                         | 3,300   |
| C       | 1 : 1 : 2                      | 112                | 1¼                                       | 2½                         | 3,750   |
| D       | 1 : 3 : 5                      | 112                | 3¼                                       | 6¼                         | 1,800   |

43. CONSISTENCY OF CONCRETE.—Only sufficient water shall be added to the cement and aggregate during mixing to produce a consistency such that the concrete shall be sufficiently workable to enable it to be well consolidated, to be worked into the corners of the shuttering and around the reinforcement, and to give the specified surface finish, and to produce a concrete having the specified strength.

The consistency shall be determined by making trial mixes with dried aggregates or when so directed by laboratory-made test cubes as hereinafter specified. The slump of the trial mix of approved consistency shall be measured as hereinafter specified. This slump shall not be exceeded throughout all batches of concrete made from the same materials mixed in the same proportions as the trial mixes and used in those parts of the Works as directed. In no case shall the slump exceed 6 in. nor exceed

4 in. for concrete in slabs, nor exceed 1 in. for concrete consolidated by mechanical vibration. The slump test shall be made on concrete actually being placed in the Works at the commencement of each period of concrete placing and at such other times as directed.

If difficulty be experienced in placing the concrete of specified mix and approved consistency between and below the reinforcement bars in the bottom of beams and similar units, the bars shall be embedded in a concrete of improved workability by increasing the proportion of cement by an approved amount and using aggregates of approved smaller maximum size than specified.

44. **SLUMP TEST.**—The apparatus used for the slump test shall be a truncated cone 12 in. high, 4 in. diameter at the top and 8 in. diameter at the bottom and made from No. 20 gauge galvansed iron. A pair of handles shall be provided on the outside. The inside face shall be free from projections. The cone shall be placed on a board with the larger end downwards and shall be filled with concrete placed in four successive 3-in. layers, each layer being punned fifteen times with a  $\frac{3}{8}$ -in. diameter mild steel rod. When the cone be filled, it shall be raised vertically clear of the concrete and the measurement of the slump shall be 12 in. minus the height of the slumped heap of concrete.

45. **MIXING CONCRETE.**—The cement and aggregates shall be thoroughly mixed together in the specified proportions in a batch-type mechanical mixer. The water shall be admitted to the drum of the mixer only when all the cement and aggregate constituting one batch are in the drum. The concrete shall be mixed until the mixture is of uniform colour and in no case for less than one minute if the peripheral speed of the mixer drum is 200 ft. per minute. If the drum rotates at lower speeds the minimum period shall be increased inversely proportionally to that speed. The period of mixing shall be measured from the time when all the materials and the water are in the drum.

The entire contents of the mixer drum shall be discharged before materials for the succeeding batch are placed in the drum. Materials spilled from the skip or other container shall not be used. No partly-set or frozen concrete shall be remixed with water nor shall excessively wet concrete be stiffened by the addition of cement or aggregate. Such partly-set or wet concrete shall not be used on the Works and shall be immediately removed therefrom.

If mixing concrete by hand be approved, the instructions of the Engineer shall be followed.

46. **CONCRETE STRENGTHS.**—The strength of the concrete at twenty-eight days shall be not less than that specified in *Table A* for the respective mixes, except that if the use of rapid-hardening Portland cement be approved the specified strengths shall be attained at seven days. The concrete strength shall be ascertained by testing 6-in. site-made cubes of concrete as hereinafter specified.

47. **SITE-MADE CONCRETE TEST CUBES.**—The test cube moulds shall be of metal and true to shape to give a 6-in. cube and shall be well oiled before filling.

The moulds shall be filled with concrete taken from that actually being placed in the Works, the concrete being selected by the Engineer from a point as near as possible to the position of placing. The filling of the mould shall be done immediately after the selection of the sample and in such a way that the concrete in the moulds be truly representative of that in the Works. The concrete shall be placed in the moulds in three layers of equal thickness, each layer being rammed with twenty-five strokes of a steel bar  $1\frac{1}{4}$  in. in diameter (or equivalent) weighing 4 lb.

The cubes shall be made in batches of three from each selected concrete sample and, unless instructed to the contrary, a batch of cubes shall be made at weekly intervals, and when the concrete mix or materials be changed, and when concrete is placed in cold weather and other abnormal conditions, and for such separate parts of the Works as the Engineer shall direct. Each cube shall be marked with the date of manufacture and an identification mark, a record being kept for each batch of cubes showing the position in the Works which the concrete represents, the date of manufacture, the identification marks on the cubes, the temperature at the time of manufacture, the mix, the slump of the concrete, particulars of the cement and

aggregates used, a statement as to whether or not the cubes were vibrated, and other information relating to the subsequent history of the cubes.

The moulds containing the test cubes shall be stored for twenty-four hours on the site in a damp place free from vibration or extreme cold. At the end of this period the cubes shall be taken from the moulds and stored in damp sand for twenty days if they are to be tested at twenty-eight days or for four days if they are to be tested at seven days. The Contractor shall despatch the cubes to an approved laboratory as directed.

The Contractor shall pay all costs incurred in supplying the material for, and in making, maturing, delivering, and testing the concrete cubes, and shall be reimbursed for the costs of all batches of cubes that attain the specified strength.

48. LABORATORY-MADE CONCRETE TEST CUBES.—When instructed, tests shall be made on laboratory-made concrete test cubes for the following purposes: (a) Examining as hereinbefore specified the materials proposed to be used or actually used for the concrete in the Works; (b) Determining the consistency and workability of the concrete; (c) Adjustment of the specified proportions; (d) Any purpose other than the foregoing. If so instructed before or during the progress of the Works, the Contractor shall supply and deliver to an approved laboratory or elsewhere samples of the cement and aggregates and water in sufficient quantities to enable the laboratory test cubes to be made.

If the tests be made for the purpose (a) hereinbefore specified, the strength of the laboratory-made cubes shall be not less than 50 per cent. in excess of the strength specified in Table A at twenty-eight days for ordinary Portland cement concrete, or at seven days for rapid-hardening Portland cement concrete. If the cubes do not attain the specified strength, the cement or aggregates or water used in the making of the cubes shall not be used on the Works. Notwithstanding the fact that the laboratory-made concrete test cubes attain the specified strength, the Engineer shall be empowered to withhold approval of the cement or aggregates or water if they do not comply with other specified requirements.

The Contractor shall pay all costs relating to the supply and delivery of the materials and the making and testing of the laboratory-made cubes, and shall be reimbursed for such costs, except for the costs relating to batches of cubes made for purpose (a) that fail to attain the strength hereinbefore specified.

49. DISTRIBUTION OF CONCRETE.—The concrete shall be distributed from the mixers to the position of placing in the Works by approved means that do not cause separation or otherwise impair the quality of the concrete.

When distribution by chutes be approved, all parts of the chutes in contact with the concrete shall be of metal. The chutes shall be laid to a slope that is uniform throughout and not steeper than one-in-two nor so steep as to produce separation. Concrete from the chutes shall be discharged on to a banker or into a hopper before being placed in the work.

When distribution by pump be approved, a continuous flow of concrete without air-pockets shall be maintained in the pipeline.

Mixers, barrows, spades, chutes, pumps, and other mixing and distributing equipment shall be thoroughly clean before commencing each period of concrete placing and such equipment shall be kept free from hardened concrete.

50. PREPARATIONS FOR PLACING CONCRETE.—Before proceeding to place the concrete, the shuttering shall be trued-up and any water accumulated therein shall be removed. All sawdust, chips, nails, and other debris shall be washed-out or otherwise removed from within the shuttering. The reinforcement shall be re-inspected for accuracy of fixing. Immediately prior to placing the concrete, the shuttering shall, except in frosty weather, be well wetted and inspection openings shall be closed.

51. PLACING CONCRETE.—The interval between adding the water to the concrete materials and completion of the concrete placing operations shall not exceed twenty-five minutes.

Except where otherwise approved for slabs and bulky sections, concrete shall be placed in the shuttering by shovels or other approved implements and shall not

be dropped from a height nor handled in a manner to cause separation. Accumulations of hardened concrete droppings on the reinforcement shall be avoided. Concrete shall be placed directly in its permanent position and shall not be worked along the shuttering to that position.

Each layer of concrete while being placed shall be consolidated by approved methods of ramming, tamping, or vibration to form a dense mass and a surface free from honeycombing and tolerably free from water and air holes or other blemishes. Particular care shall be taken to tamp the concrete between the reinforcement and the face of the shuttering so as to produce a dense fair surface. The number and type of vibrators shall be approved before consolidating by vibration. Placing and consolidation of concrete shall be done in such a manner as not to disturb concrete already placed, and reinforcement projecting from concrete already placed shall not be vibrated or jarred.

Any water accumulating on the surface of the newly-placed concrete shall be removed by approved means and no further concrete shall be placed thereon until such water be removed.

No unset concrete shall be brought into contact with unset concrete containing a cement of a different type.

Unless otherwise approved or instructed, concrete shall be placed in a single operation to the full depth of slabs, beams, and members similar thereto, and shall be placed in horizontal layers not exceeding 3 ft. deep in walls, columns, and members similar thereto. Concrete shall be placed continuously until completion of the part of the work between construction joints as specified hereinafter or of a part of approved extent. At the completion of a specified or approved part a construction joint of the form and in the position hereinafter specified shall be made. If a temporary cessation of concrete placing be unavoidable elsewhere a construction joint shall likewise be made.

52. PLACING CONCRETE IN COLD WEATHER.—No concrete shall be mixed or placed while the temperature is below 34 deg. F. on a rising thermometer or below 36 deg. F. on a falling thermometer. The Contractor shall supply an accurate maximum and minimum thermometer and hang it in an approved shaded position away from heat.

Aggregates that have been exposed to frost shall not be used until completely thawed.

Concrete shall be maintained by approved means at a temperature of not less than 40 deg. F. during placing and for a period of three days thereafter, or for a period of one day thereafter if rapid-hardening Portland cement be used. All concrete placed during cold weather or when a frost be predicted or be likely to occur or occurs contrary to expectation, shall be protected from freezing by approved means.

53. CONSTRUCTION JOINTS.—Construction joints shall be made in the positions hereinafter specified or elsewhere as approved but the work shall be arranged so that the number of construction joints is reduced to a minimum. Such joints shall be truly vertical or horizontal, as the case may be, except that in the arch the joint shall be strictly at right-angles to the axis of the arch. Construction joints shall be rebated to an approved profile. Vertical joints shall be formed by inserting temporary boards, corrugated horizontally where practicable, against which the concrete shall be rammed. The provision of such boards shall be deemed to be included in the Contractor's rates and shall not be measured as shuttering.

Construction joints shall be made horizontally 18 in. above the top of foundations of retaining walls, and horizontally at the bottom of the splay at the head of all walls. Concrete in splays at the junction of walls and slabs shall be placed at the same time as that in the slab. Construction joints in slabs shall be made parallel to the main reinforcement and where required at right-angles to the main reinforcement shall be made vertically at midspan. Construction joints in the retaining walls and arch slab shall be made in the positions directed, and concreting shall be executed in alternate panels of the walls and in alternate sections of the arch slab or otherwise as directed by the Engineer.

Before placing new concrete against concrete already set, the old concrete face



shall be cleaned and scum or laitance removed. The face shall be roughened and any loose aggregate removed therefrom. Immediately before placing the new concrete the face of the old concrete shall be thoroughly wetted and a coating of neat cement grout applied. The new concrete shall be well rammed against the prepared face before the grout sets.

54. EXPANSION JOINTS.—Expansion joints shall be made in the positions and of the form shown on the drawings and described in the Bills of Quantities.

55. CURING AND PROTECTION OF CONCRETE.—Newly-placed concrete shall be protected from rain, and during hot, dry, or windy weather approved coverings shall be provided to prevent premature drying-out. The concrete shall also be protected from frost as hereinbefore specified. All exposed faces of concrete shall be kept moist by approved means for seven days after placing or for three days if rapid-hardening Portland cement be used, except when there be danger of the curing water or damp coverings freezing.

Concrete in foundations and other work below the ground shall be protected from admixture with falling earth during and after placing. Approved means shall be taken to protect immature concrete from damage by floating debris, ice, and similar material. Slabs and other work shall be protected from damage by workmen, equipment, overloading, or any other cause.

Concrete damaged from any cause shall be cut out and replaced by sound concrete at the Contractor's expense.

56. REMOVAL OF SHUTTERING.—Shuttering and centering shall be removed by gradual easing without jarring, and only in the presence of a competent supervisor. Before removal of the shuttering the concrete shall be examined, and removal shall only proceed if the concrete has attained sufficient strength to support its own weight and any constructional or other loads likely to come upon it. If any loading in excess of the design load be anticipated, approved props shall be provided after removal of the shuttering. The Contractor shall record on the drawings or elsewhere the date upon which each part of the work is concreted together with the date upon which the shuttering is removed.

No shuttering or centering shall be removed until an approved period has elapsed since the last day on which concrete was placed in the part of the Works concerned. Notwithstanding the approval of the Engineer, the assessment of the period that shall so elapse and any damage or other consequences arising therefrom shall be the Contractor's entire responsibility.

57. FINISHES.—The shuttering for exposed concrete faces shall be so constructed that the latter shall be true to line and surface. The concrete shall be consolidated as specified in and against the shuttering so that the face of the work shall be free from honeycombing and other blemishes. If, upon removal of the shuttering, the line or surface of the work is in the opinion of the Engineer unsightly and not in accordance with the requirements of the contract, the Contractor shall at his own expense cut out and make good such portion of the work as the Engineer directs. Rendering over defective surfaces shall not be permitted. Small areas of honeycombing shall with the approval of the Engineer be made good immediately upon removal of the shuttering, and isolated superficial air and water holes shall be filled in.

The shuttering of the exposed faces of the approach retaining walls shall be made up with weatherboarding in lengths as long as possible and so arranged that upon removal of the shuttering the concrete face shall show truly horizontal ridges tapered from  $\frac{1}{4}$  in. deep and at intervals of 6 in. The surface of the approach retaining walls is to be lightly bush-hammered as specified hereinafter.

The shuttering to the exposed face of the arch ring and to the splayed feature at the base of the abutments and to the continuous stringcourse at the base of the parapet is to be lined with an approved lining to give an extra smooth surface. This lining shall also extend under the soffit of the arch for a distance of 2 ft. 6 in. from each outer edge.

The remainder of the spandrel walls, pilasters, and arch soffit is to be lightly bush-hammered. The bush-hammering shall be executed with an approved tool and only by competent workmen. Before proceeding to bush-hammer the entire

area to be so treated, the Contractor shall prepare an area measuring 2 ft. 6 in. square as a sample which upon approval by the Engineer shall be considered as the standard of bush-hammering to be maintained throughout. The finished surface shall be of uniform texture, free from depressions, markings, or other defects.

Concealed concrete faces shall be left as from the shuttering provided that honeycombed surfaces shall be made good. The top face of the deck slab shall be levelled and floated with a wooden float to a smooth finish at the levels and falls shown on the drawings or elsewhere. The floating shall not be executed to the extent of bringing excess fine material to the surface.

58. PRECAST CONCRETE PILES.—The precast reinforced concrete piles shall be manufactured on the site in lengths as directed. The concrete shall be quality D as hereinbefore specified.

Shoes, reinforcement, forks, links, toggle-hole tubes, and other fittings shall be fixed accurately in the positions shown on the drawings. Shoes shall be fitted with the point axial with the pile. The lower ends of the reinforcement bars shall bear on the top of the shoe and the upper ends of the bars shall not differ in level by more than  $\frac{1}{4}$  in.

The moulds shall be so supported that the pile is not distorted during casting or subsequently. The sides of the moulds shall not be removed until two days after casting and the pile shall not be disturbed for at least seven days after casting.

Notwithstanding the foregoing requirements, the Contractor shall be responsible for any damage done to the pile due to the sides of the moulds being removed or the pile being removed from the mould bottom too soon or from any other cause, and all piles damaged during manufacture, handling, driving, or at any other time shall be replaced at the Contractor's expense.

The piles shall be removed from the mould bottoms only by canting sideways and rolling to the stacking ground for final curing. The runners or other supports upon which the piles are canted or rolled shall be not more than 6 ft. apart and shall be level with each other.

The piles are to be kept continuously damp for a period of at least ten days after casting, except in frosty weather.

Otherwise than aforesaid the piles shall not be handled, slung, pitched, or driven until six weeks after casting, and shall be protected from damage by any cause. The piles shall only be slung from the toggle-holes provided in the positions shown on the drawings.

The piles shall be driven with a 2-ton semi-automatic hammer with a drop as directed or other approved driving equipment operated from an approved type of frame. During driving the pile-head shall be fitted with an approved cast-steel helmet with a timber stub-dolly and with suitable packing below the helmet. The dolly and packing shall be renewed as often as is necessary to protect the pile head from damage. When the driving of any pile commences it shall continue without cessation for any avoidable cause until the pile shall be driven down to rock to the satisfaction of the Engineer.

The piles shall be driven in the position shown on the drawings or within 3 in. thereof, and shall be at the inclination shown on the drawings or within  $1\frac{1}{2}$  deg. thereof. The sequence of driving the piles shall be left to the discretion of the Contractor who shall be responsible if the driving of a pile shall cause defects in position or inclination, except within the aforementioned tolerances, of piles already driven. If a pile is at any time out of position or inclination by more than the aforementioned tolerances, the Engineer shall direct that, at the Contractor's expense, the pile be extracted and redriven, or a new pile driven in lieu thereof in conformity with this specification.

A record of the driving of each pile shall be kept in the form to be prescribed by the Engineer.

59. TEST PILES.—Before casting the bulk of the piles the Contractor shall manufacture, cure, and drive entirely in accordance with this specification and in positions as directed, two 14-in. square test piles each 30 ft. long, which shall remain as two of the permanent piles under the abutment. Records of the driving of the

two test piles shall be taken as directed. The Contractor shall allow for the manufacture of the remaining piles to commence only after these test piles have been driven and when so instructed by the Engineer.

60. STRIPPING HEADS OF PILES.—After they are driven, the concrete shall be cut away from the portion of the piles extending above a level 3 in. above the bottom of the abutment without damaging the reinforcement. The binders, links, forks, and toggle-hole tubes within this portion shall be removed and the main bar reinforcement shall, if so directed, then be bent into the body of the abutment.

61. PRECAST CONCRETE PARAPET BLOCKS AND COPING SLABS.—The parapet blocks and coping slabs shall be precast on the site and shall consist of concrete of quality A with the aggregates hereinbefore specified. The moulds shall be metal-faced and of such construction as to produce units free from joint marks, and shall be cleaned and trued before each casting operation. Where the parapet blocks are to have imitation stone faces the moulds shall be manufactured to produce a rock-face effect on both exposed faces and such moulds shall be approved by the Engineer before use.

The parapet wall blocks shall be 12 in. thick by  $8\frac{1}{2}$  in. deep approximately by 2 ft. 6 in. long. The pilaster blocks shall be 21 in. thick by 28 in. deep.

The coping slabs for the parapet wall shall be of weathered section 12 in. wide by 7 in. maximum depth and shall be supplied in lengths of approximately 3 ft. Over the pilasters the coping slabs shall be 28 in. wide by 7 in. maximum depth. The coping slabs shall be fixed with  $\frac{1}{2}$ -in. diameter copper dowels 5 in. long between adjacent blocks fitting into 3-in. diameter holes  $2\frac{1}{2}$  in. deep.

The precast units shall have sharp arrises and faces free from air holes or other defects and shall be not less than two months old when incorporated in the work. No blocks having patched faces or arrises shall be used in the work.

The parapet blocks and coping slabs shall be erected plumb and true to line and shall be bedded and jointed in 1 : 2 cement mortar. Beds and joints shall be raked out to a depth of 1 in. and pointed with gauged mortar neatly drawn with a round key. All exposed faces shall be wire brushed to bring out the glitter effect to the Engineer's satisfaction.

When built, the parapets shall be protected by timber guards until the completion of the Contract. The Contractor shall provide any scaffolding required during the erection and after-treatment of the parapet.

62. LOADING TEST.—The Engineer shall instruct that a loading test be made on the Works or any part thereof if in his opinion such a test be deemed necessary for one or more of the reasons hereinbelow specified: (a) The site-made concrete test cubes failing to attain the specified strength; (b) The shuttering being prematurely removed; (c) Overloading during construction of the Works or part thereof; (d) Concrete improperly cured; (e) Any other circumstances attributable to alleged negligence on the part of the Contractor which in the opinion of the Engineer results in the Works or part thereof being of less than the expected strength; (f) Any reason other than the foregoing.

If the loading test be instructed to be made solely or in part for the reason (a) the test shall be made at the Contractor's own cost. If the test be instructed to be made for one or more of the reasons (b) to (e) inclusive the Contractor shall be reimbursed for the cost of the test if the result thereof be satisfactory. If the test be instructed to be made for the reason (f) hereinbefore specified, the Contractor shall make the test and shall be reimbursed for all costs relating thereto irrespective of the result of the test.

The test load shall not be applied within eighty-four days of the completion of placing of the concrete in the part of the Works to be tested, and the latter shall not be supported during the test by the shuttering or other non-permanent support. Means shall however be taken to ensure that in the event of failure under the test temporary support of the loaded member shall be immediately available. The test shall proceed strictly as instructed.

If the result of the loading test is not satisfactory in the opinion of the Engineer, the Engineer shall instruct that the part of the Works concerned shall be taken down

or cut out and reconstructed to comply with this Specification, or that other remedial measures shall be taken to make the Works secure. If the test be instructed to be made for one or more of the reasons (a) to (e) inclusive, the Contractor shall take down or cut out and reconstruct the defective work or shall take the remedial measures instructed all at his own cost.

63. PLACING FILLING.—The filling between the retaining walls, behind the abutments, between the spandrel walls over the arch, and in the embankment shall be deposited in layers not exceeding 1 ft. in thickness. Natural hollows shall be filled first in layers each of which shall be consolidated to the degree of compactness specified hereinafter. Each layer shall be thoroughly consolidated with a roller of not less than 10 tons weight and rolling shall continue until no visible settlement is produced by the passage of the roller. Where the rolling produces a depression that in the opinion of the Engineer is excessive, the depression shall be filled with material and rolled as aforesaid before depositing the next layer.

In places where a mechanical roller cannot operate, the successive layers of filling shall each be rammed by a hand-rammer or other approved apparatus to the same degree of consolidation as where rolled.

Each layer shall extend the full width between the retaining walls or the full width of the embankment, making proper allowance for the slopes. Greater widths and flatter slopes to the embankment if so directed shall be formed to allow for subsidence, shrinkage, and final consolidation so that the proper lines, levels, and slopes shall ultimately be obtained without requiring additions to be made thereto. Care shall be taken where the embankments are built over drains to prevent damage to the latter, and the filling shall be carefully rammed by hand in layers and brought up equally on both sides of the drain.

The foregoing requirements in respect to consolidating the filling shall in no way relieve the Contractor of his obligation under this contract and in particular as to his responsibility in respect to the character of the materials used for forming the embankments or upon which the embankments are built or through which drains are laid.

64. FORMATION FOR ROADS.—The formation under the roads shall be covered with a layer of hard well-burnt engine ashes and rolled with a roller of not less than 10 tons weight and consolidated to the thickness and to the levels shown on the drawings, which allow for the camber, cross-fall, super-elevation, and other variations in the contour of the finished road. Should any clay or mud work through the surface of the ashes before, during, or after consolidation, or should any depression occur, the affected areas shall be dug out and made good at the Contractor's expense.

65. BOTTOM COURSE FOR ROADS.—The bottom course shall be laid on the formation and shall consist of approved whinstone pitching as specified, hand-set so that only a minimum area of the formation shall be left uncovered. Projecting heads shall then be knocked off and the whole thoroughly and properly pinned to fill the voids in the pitching. The latter shall then be blinded with approved material as specified and thoroughly rolled wheel to wheel with a 10-ton road roller. Subsidence, depressions, and malformations shall be dug out and made good at the Contractor's expense and to the satisfaction of the Engineer.

66. SURFACE OF APPROACH ROADS.—The surface of the approach roads shall be formed by spreading on the bottom course a layer of bituminous macadam as specified. The macadam shall be spread evenly and rolled true to line and level and shall have a thickness of not less than 3 in. after consolidation. The consolidation shall be effected by a road roller weighing not less than 10 tons or more than 12 tons. The levels of the finished bottom layer shall allow for the cambers, cross-falls, and super-elevations shown on the drawings and shall be so adjusted in the vicinity of the road gullies as to conduct surface water to the latter and to prevent water lying in the channels or elsewhere. This layer shall be maintained in the specified condition and to approved levels for a period of twelve months from the date the road is opened to public traffic.

Immediately upon expiry of this period the top layer of bituminous macadam as specified shall be spread and consolidated to a thickness of not less than 2 in. and

shall conform to the finished lines and levels shown on the drawings or elsewhere, adjustments being made where necessary to conduct all surface water to the road gullies.

67. SURFACE OF ROAD OVER BRIDGE.—The consolidated thickness of the single-coat asphalt surface to the road over the bridge shall be not less than 3 in. excluding the chippings projecting above the wearing surface. The finished surface shall be to the lines and cambers, cross-falls, superelevation, or other levels shown on the drawings or elsewhere, and the levels shall be adjusted as necessary to ensure that all surface water is conducted to the road gullies.

The specified mixture shall be delivered to the site in clean containers and protected from the weather. Each load shall be discharged on to clean plates and shall be immediately distributed into place and spread, while hot, on the foundation by means of heated rakes. The mixture shall be maintained clean throughout all operations, and the foundation shall be swept clean before depositing the mixture. The consolidation shall be effected with a roller weighing not less than 6 tons and shall be continued until no impression is made by the roller on the newly-laid surface.

While the compressed asphalt is still warm and in a plastic condition, a layer of chippings shall be spread uniformly such that 1 ton of chippings shall cover not less than 100 sq. yd. or more than 150 sq. yd. The chippings shall be rolled or otherwise pressed into the asphalt so as to project above the surface. A strip of asphalt, not less than 6 in. or more than 9 in. wide, shall be left against the kerbs free from chippings.

At the end of each period of laying the asphalt, the material shall be finished against a board, and when laying is resumed the exposed edge of the joint shall be cut back and painted with a thin coating of asphaltic cement or bituminous emulsion. All kerbs, manholes, gullies, and similar projections against which the asphalt abuts shall be likewise painted before the mixture is laid. The mixture shall be tamped around and against such projections by hot tampers and the finished surface shall be left flush or shall project not more than  $\frac{1}{4}$  in. above such projections.

The surface of the road over the bridge shall be maintained to the satisfaction of the Engineer and at the Contractor's expense for a period of five years from the date the road is opened to public traffic.

68. SCARIFYING EXISTING CARRIAGEWAY.—Where the existing carriageway abuts on the new road, the surface of the former shall be scarified, shaped, rolled, and formed to approved lines and levels to receive the new surfacing.

69. FORMATION FOR FOOTPATHS.—The surface of the filling under the footpaths shall be cleaned free from mud and water, and shall be rolled with a power roller weighing approximately 3 tons. Any depressions or parts not presenting a clean surface after rolling shall be dug out and replaced by sound clean material and consolidated by rolling. Approved hardcore shall be spread, consolidated, and blinded, the thickness after consolidation being not less than 4 in. The finished surface of the formation shall be true to lines and levels and prepared to take bituminous macadam on the approaches and paving flags over the bridge.

70. SURFACE OF FOOTPATHS ON APPROACHES.—For the surface of the footpaths on the approaches a layer of bituminous macadam shall be spread and consolidated to a finished thickness of not less than  $1\frac{1}{2}$  in., the surface being true to the lines, falls, and levels shown on the drawings or elsewhere.

71. SURFACE OF FOOTPATHS ON BRIDGE.—The surface of the footpaths on the bridge shall be formed with precast concrete flags as specified, well bedded with flush joints on sand and ashes and to the lines, falls, and levels shown on the drawings or elsewhere. The joints shall be close fitting and shall be set in 1 : 2 cement mortar.

72. KERBS.—The straight units of precast kerbs shall be accurately aligned to the curves, lines, and levels shown on the drawings or elsewhere, and shall be bedded, jointed, and neatly pointed in 1 : 2 cement mortar. A backing of concrete quality D not less than 4 in. thick shall be provided. When laid the kerbs shall project not less than 5 in. above the contiguous final road surface.

73. COVERING AND SOWING SLOPES AND MARGINS.—The slopes of the embankment and all margins and verges after being formed and trimmed to the specified

profile shall be covered to a depth of 4 in. with selected excavated soil laid aside for this purpose or obtained by the Contractor from another source. The soil shall be sieved and neatly raked and sown at the rate of 1 lb. of grass seed as specified for each 25 sq. yd. If the seed when sown fails from any cause, or if the soil becomes displaced, the sowing shall be repeated at the Contractor's expense until the Engineer is satisfied that a good sward is obtained.

74. ERECTION OF FENCING.—Post and wire fencing as specified shall be erected along the lines shown on the drawings or elsewhere as directed. The posts shall be embedded for a length of 2 ft. 3 in. in a block of concrete of quality D. Straining posts shall be embedded for a depth of 2 ft. 9 in.

## APPENDIX III

### TYPICAL BILLS OF QUANTITIES

THE following Bill of Quantities relates to the same contract as the Specification in Appendix II, and should be read in conjunction with the Conditions of Contract in Appendix I.

#### BILLS OF QUANTITIES.

(a) In accordance with Clause 57 of the Conditions these Bills are prepared and measurements have been made in accordance with the Report of the Committee on Engineering Quantities of the Institution of Civil Engineers unless otherwise described herein.

(b) The rates and prices inserted by the Contractor in the Bills are to be full inclusive rates and prices for the finished work described in the respective items and to include for all labour, materials, temporary work, plant, overhead charges and profit as well as for general liabilities, obligations, and risks arising out of the Conditions of Contract and for such other matters as may be specifically described herein, except insofar as any materials, labours, temporary work, or other matters are specifically measured separately herein.

#### Section A.—Preliminaries.

Note. The following items from the Conditions of Contract and the Specification are entered here so that the Contractor may place against them any sum or sums which he may consider necessary if he is of the opinion that such sum or sums are not covered by the rates given in the succeeding items in the Bills of Quantities. If no sum is entered against a particular item it will be deemed to mean that the inclusive cost of the whole of the work or service or other matter represented by that item as described in the Conditions of Contract or Specification has been included in the rates given in the Bills of Quantities and no claim in respect thereof will be entertained. The sum or sums entered against the following items shall be deemed to be the inclusive cost of the whole of the work or service or other matter represented by that item as described in the Conditions of Contract or Specification.

| Item                            | Particulars                   | Unit | Quant | Rate | £ | s | d |
|---------------------------------|-------------------------------|------|-------|------|---|---|---|
| " Conditions "<br>Clause<br>No. |                               |      |       |      |   |   |   |
| 7                               | Additional copies of drawings | sum  |       |      |   |   |   |
| 10                              | Sureties                      | sum  |       |      |   |   |   |
| 11                              | Inspection of site            | sum  |       |      |   |   |   |
| 14                              | Programme                     | sum  |       |      |   |   |   |
| 15                              | Superintendence               | sum  |       |      |   |   |   |
| 17                              | Setting-out                   | sum  |       |      |   |   |   |
| 19                              | Watching and lighting         | sum  |       |      |   |   |   |
| 21                              | Indemnify employer            | sum  |       |      |   |   |   |
|                                 | Carried forward :             |      |       | £    |   |   |   |

| Item                               | Particulars  | Unit    | Quant     | Rate | £ | s. | d. |
|------------------------------------|--|---------|-----------|------|---|----|----|
| "Condi-<br>tions"<br>Clause<br>No. |  | Brought | forward : |      |   |    |    |
| 23                                 | Insurance of works   | sum     |           |      |   |    |    |
| 25                                 | Workmen's insurance  | sum     |           |      |   |    |    |
| 26                                 | Giving notices and payment of fees   | sum     |           |      |   |    |    |
| 28                                 | Royalties  | sum     |           |      |   |    |    |
| 30                                 | Extraordinary traffic  | sum     |           |      |   |    |    |
| 33                                 | Clearance of site on completion  | sum     |           |      |   |    |    |
| 36                                 | Tests  | sum     |           |      |   |    |    |
| 42                                 | Wayleaves  | sum     |           |      |   |    |    |
| 49                                 | Maintenance  | sum     |           |      |   |    |    |
| 56                                 | Measurement of works<br>(Add any other clauses deemed<br>necessary)  | sum     |           |      |   |    |    |
|                                    | NOTE.—The clauses in the Specifica-<br>tion should be enumerated and<br>briefly described here so that the<br>contractor can enter a price against<br>any of the requirements if neces-<br>sary. |         |           |      |   |    |    |
|                                    | Total of Section A carried to<br>Summary   |         |           |      | £ |    |    |

### Section B.—Clearing Site, Excavation, and Filling.

#### PREAMBLE.

(a) The quantities for excavation are measured net cubical contents of the voids to be formed by the removal of the material excavated in accordance with drawings or other instructions.

(b) Excavation in trenches is the net measurement obtained by multiplying the horizontal area of the foundation by the mean depth below the surface.

(c) The Contractor is to include in the prices for any additional excavation required beyond the net width of the foundations for working space, timbering, cofferdams, or other temporary works.

(d) No allowance in measurement has been made for bulking.

(e) The quantities of excavation are not guaranteed correct, but have been measured with reasonable accuracy from the information available. In accordance with Clause 55 of the Conditions of Contract the quantities are not to be taken as the actual or correct quantities.

(f) The rates and sums entered by the Contractor for excavation and similar items are deemed to include for timbering and other temporary works (excluding cofferdams), for upholding and maintaining the excavation, trimming bottoms of excavation to receive concrete, maintaining the surface of the excavation as specified and keeping the excavation, whether within cofferdams or not, clear of water by pumping, baling, or otherwise, and to include any contingency due to tidal action or floods.

(g) The measurements for filling are taken in final position as consolidated to the outlines and levels of the finished work as shown on the drawings.



TYPICAL BILLS OF QUANTITIES

CLEARING SITE.

| Item | Particulars   | Unit    | Quant | Rate | £ | s. | d. |
|------|---|---------|-------|------|---|----|----|
| 1    | Fell trees, cut down bushes, and dispose of as specified  | sum     |       |      |   |    |    |
| 2    | Take down existing timber fences, lay aside as directed, and make good end of fence left standing by means of new posts and stays   | lin. ft | 160   |      |   |    |    |
| 3    | Demolish existing masonry parapet wall, coping, and pilaster and lay aside debris as directed   | lin ft  | 120   |      |   |    |    |
| 4    | Take down existing concrete posts and wire fence, make good and re-erect in new position as directed; include inter alia for digging holes and forming concrete bases for posts and for painting posts two coats white lead paint upon completion | lin ft  | 210   |      |   |    |    |
| 5    | Take down existing notice boards and supporting posts and struts, lay aside as directed, make good and re-erect in new position to be indicated on completion of Works  | No      | 2     |      |   |    |    |
| 6    | Remove existing field gate and gate-posts, make good, and re-erect complete in new position as directed   | sum     |       |      |   |    |    |
| 7    | Break up existing reinforced concrete slab in front of the premises of Messrs. A. & B and dispose of debris as directed   | sq yd   | 485   |      |   |    |    |
| 8    | Clear beach as specified over the area of the Works   | sum     |       |      |   |    |    |
| 9    | Strip turf and stack for re-use as directed   | sq yd.  | 2,250 |      |   |    |    |

EXCAVATION.

|    |  |          |       |   |  |  |  |
|----|--|----------|-------|---|--|--|--|
| 10 | Excavate and lay aside for re-use as directed top 6-in. layer of vegetable soil; include for disposal of excess and unsuitable material  | sq yd    | 2,250 |   |  |  |  |
| 11 | Excavate in drain trenches 2 ft. 6 in average width and 3 ft average depth but not exceeding 5 ft deep in any material other than solid rock and lay aside for refilling, include for disposal of excess and unsuitable material | cu. yd   | 380   |   |  |  |  |
| 12 | Extra only over Item 11 for depths exceeding 5 ft. but not exceeding 10 ft.  | cu yd.   | 150   |   |  |  |  |
| 13 | Extra only over Items 11 and 12 for excavation in rock   | cu. yd.  | 35    |   |  |  |  |
| 14 | Excavate in trenches for 4-in. drain, average depth 2 ft and not exceeding 5 ft. deep  | lin. yd. | 125   |   |  |  |  |
|    | Carried forward  |          |       | £ |  |  |  |

## EXCAVATION WITHIN COFFERDAMS (TIDAL WORK).

| Item | Particulars   | Unit              | Quant | Rate | £ | s. | d. |
|------|---|-------------------|-------|------|---|----|----|
|      |   | Brought forward : |       |      |   |    |    |
| 15   | Provide, maintain, and remove cofferdams for all retaining walls as specified, including for pumping or other means of keeping dry  | sum               |       |      |   |    |    |
| 16   | Ditto for south abutment  | sum               |       |      |   |    |    |
| 17   | Ditto for north abutment  | sum               |       |      |   |    |    |
| 18   | Remove river mud and similar material from river bed over whole area within cofferdams preparatory to commencing main excavation  | sq. yd            | 1,650 |      |   |    |    |
| 19   | Excavate for retaining walls within cofferdams after removal of mud (as in last) in any material other than rock to a depth not exceeding 5 ft below the level of H.W.O.S.T and part return fill and ram before removal of cofferdam, and lay aside surplus material to be used for filling as directed elsewhere | cu yd             | 1,200 |      |   |    |    |
| 20   | Ditto but above H.W.O.S.T.  | cu yd             | 250   |      |   |    |    |
| 21   | Extra only over Items 19 and 20 for depths exceeding 5 ft. but not exceeding 10 ft.   | cu. yd            | 550   |      |   |    |    |
| 22   | Extra only over Items 19, 20, and 21 for excavation in rock   | cu yd             | 300   |      |   |    |    |
| 23   | Excavate all as Item 19 but for abutments   | cu yd             | 480   |      |   |    |    |
| 24   | Extra only over Item 23 for depths exceeding 5 ft but not exceeding 10 ft.  | cu yd.            | 450   |      |   |    |    |
| 25   | Ditto exceeding 10 ft. but not exceeding 15 ft  | cu. yd            | 180   |      |   |    |    |
| 26   | Ditto exceeding 15 ft but not exceeding 20 ft.  | cu yd             | 35    |      |   |    |    |
| 27   | Extra only over Items 23 to 26 for excavating in rock   | cu yd             | 25    |      |   |    |    |
| 28   | Extra only over Item 27 for benching surface of rock excavation to slopes shown on the drawings for abutments   | sq yd.            | 255   |      |   |    |    |

## FILLING.

|    |   |                   |       |   |  |  |  |
|----|---|-------------------|-------|---|--|--|--|
| 29 | Provide and hand-pack selected approved stone rubble in drain trenches 2 ft. 6 in. average width                          | cu yd.            | 130   |   |  |  |  |
| 30 | Fill and consolidate as specified with excavated material trenches for 4-in. drain  | lin. yd.          | 125   |   |  |  |  |
| 31 | Transport from dump, deposit, and consolidate in layers as specified filling between retaining walls and behind abutments | cu. yd            | 1,100 |   |  |  |  |
| 32 | Ditto in embankments including forming to the lines and levels shown on the drawings and for trimming the slopes          | cu. yd.           | 950   |   |  |  |  |
| 33 | Ditto over central portion of arch  | cu. yd.           | 50    |   |  |  |  |
|    |   | Carried forward : |       | £ |  |  |  |

TYPICAL BILLS OF QUANTITIES

471

| Item | Particulars  | Unit            | Quant. | Rate | £ | s. | d. |
|------|--|-----------------|--------|------|---|----|----|
|      |  | Brought forward |        |      |   |    |    |
| 34   | Extra only over Items 31 to 33 for supplying additional approved filling material  | cu yd           | 500    |      |   |    |    |
| 35   | Provide and set by hand dry-stone backing 12 in thick behind and to full height of retaining walls, including bringing up backing concurrently with filling  | sq yd.          | 1,900  |      |   |    |    |
| 36   | Soil and sow with approved grass seed, as specified, verges and slopes of new embankments with soil reserved under Item 10   | sq. yd          | 1,150  |      |   |    |    |
| 37   | Transport from dump, lay by hand, and pun with an approved beetle a margin of turf 12 in. wide along the toes of the slopes of the embankment using approved and selected turf from that reserved under Item 9 | lin ft          | 1,600  |      |   |    |    |
| 38   | Extra only over Item 37 for supplying additional approved turf to make up deficiency not available on site   | lin ft          | 150    |      |   |    |    |
|      | Total of Section B carried to Summary  |                 |        |      | £ |    |    |

Section C.—Drains.

| Item | Particulars   | Unit   | Quant. | Rate | £ | s. | d. |
|------|---|--------|--------|------|---|----|----|
| 39   | Provide, lay to the falls as directed in trench, and joint 9-in. diameter firedrill S.F. drain complete, and flush as specified   | lin yd | 250    |      |   |    |    |
| 40   | Extra only over Item 39 for 9 in junction with 4-in single branch and with round inspection eye   | No     | 8      |      |   |    |    |
| 41   | All as Item 39 but 4-in. diameter (between gullies and 9-in drain)  | lin yd | 125    |      |   |    |    |
| 42   | Extra only over Item 41 for 4-in diameter 22½ deg bends   | No     | 18     |      |   |    |    |
| 43   | Provide and lay to fall as directed, and concurrently with filling behind retaining walls, 4-in diameter cast-iron S.F. drain including for caulked lead joints and flushed as specified  | lin yd | 80     |      |   |    |    |
| 44   | Extra only over Item 43 for 4-in diameter 45 deg. cast-iron bends   | No     | 10     |      |   |    |    |
| 45   | Provide and set best quality cast-iron gullies and traps with 4-in diameter outlets, complete with gratings, covers and frames, size 22½ in. deep by 26 in. by 13½ in. Include for excavation, concrete mix "D" in bed and surround, shuttering and back filling as required, and for jointing to cast-iron drains previously described | No     | 15     |      |   |    |    |
|      | Carried forward :   |        |        |      | £ |    |    |

## REINFORCED CONCRETE BRIDGES

| m  | Particulars   | Unit            | Quant. | Rate | £  | s. | d. |
|----|---|-----------------|--------|------|----|----|----|
|    |   | Brought forward |        |      |    |    |    |
| 46 | Provide and build manholes complete, size approximately 5 ft. by 2 ft. 6 in. by 4 ft. deep internally, including excavation, concrete quality C in base, 9-in. brick walls arched over pipes, corbelled out at top and pointed and waterproofed internally, all necessary channels bedded and benched up in cement mortar and 20-in. diameter | No.             | 2      |      |    |    |    |
| 47 | Allow provisional sum of twenty-five pounds for making good connections to field drains   | sum             |        |      | 25 |    |    |
| 48 | Provide and build into retaining wall, at level below L.W.O.S.T. as shown on drawings, 4-in. diameter cast-iron pipe 2 ft. 6 in. long and include for connecting to 4-in. diameter cast-iron pipe on inner face of wall and for caulking, bolts, etc.   | No.             | 22     |      |    |    |    |
| 49 | Provide and fix complete at outlet of last cast-iron flap valves of approved pattern and manufacture; valves to be single-hinge type with gun-metal bolt and machined faces; include for connecting to 4-in. pipe   | No.             | 22     |      |    |    |    |
|    | Total of Section C carried to Summary   |                 |        |      | £  |    |    |

### Section D.—Piling.

**REAMBLE.**

(a) The concrete in the precast reinforced concrete piles is measured by multiplying the cross-sectional area of the pile by the overall length (as cast) from the head of the pile to the point of the shoe, no deduction being made for holes, shapings, reinforcement, etc.

(b) The prices for concrete in the piles shall include for the moulds.

(c) Reinforcement is measured separately (in Section E).

| Item | Particulars   | Unit    | Quant. | Rate | £ | s. | d. |
|------|---|---------|--------|------|---|----|----|
| 50   | Concrete quality B in 85 No. 14-in. square precast piles in lengths as directed exceeding 20 ft. but not exceeding 30 ft. | cu. ft. | 2,875  |      |   |    |    |
| 51   | Provide and fix in moulds before casting 2-in. gas pipe in lengths of 14 in. for forming toggle holes                     | No.     | 85     |      |   |    |    |
| 52   | Provide and fix spacer forks as specified   | No.     | 1,360  |      |   |    |    |
| 53   | Provide and fix rock type pile shoes of approved pattern  | No.     | 85     |      |   |    |    |
| 54   | Handling and pitching within cofferdams 14-in. square piles not exceeding 30 ft. long                                     | No.     | 85     |      |   |    |    |
|      | Carried forward   |         |        |      | £ |    |    |

| Item | Particulars  | Unit            | Quant. | Rate | £ | s | d. |
|------|--|-----------------|--------|------|---|---|----|
|      |  | Brought forward |        |      |   |   |    |
| 55   | Driving to batter 14-in. piles not exceeding 30 ft long in groups within cofferdams down to level of rock as specified   | No              | 85     |      |   |   |    |
| 56   | Extra only over Items 50 to 55 for manufacture and driving complete test piles as specified  | No.             | 2      |      |   |   |    |
| 57   | Stripping concrete only from heads of 14-in square piles for length as directed, exposing reinforcement, and include for bending excess length of reinforcement into foundations | No              | 85     |      |   |   |    |
|      | Total of Section D carried to Summary  |                 |        |      | £ |   |    |

**Section E.—Concrete and Reinforced Concrete.**

PREAMBLE.

(a) Shuttering is measured net area of surface of finished work to be supported during concreting.

(b) The rates and prices for shuttering and centering are to include for all supports, posts, wedges, fillets, bolts, and other connections, and all materials, labours, fittings, and other matters necessary for the supply, construction, preparation, erection, maintenance, removal, cleaning, etc., of the shuttering in accordance with the specification.

(c) The weights of reinforcement are computed from the sizes and net lengths of the bars given on the drawings or elsewhere, the basis of the calculated weight being that one foot length of bar weighs 3.4 lb. per square inch of nominal cross-section.

(d) The rates and prices for reinforcement are to include for any excess weight over the net weight [as calculated according to (c)] due to cutting to waste, rolling margin, tolerances on cutting to length, and for any extras for short lengths and for providing tying wire, spacer bars, cover blocks, and all other matters necessary for the supply, preparation, and fixing of the reinforcement in accordance with the Specification.

(e) Concrete is measured the net size of the finished work and no deduction is made for the volume of the reinforcement, or for chamfers not exceeding 6 in. by 6 in., or for holes, openings, or other voids of less than 1 cu. ft.

SHUTTERING AND CENTERING.

| Item | Particulars   | Unit    | Quant. | Rate | £ | s | d. |
|------|---|---------|--------|------|---|---|----|
| 58   | Rough boarded shuttering to vertical edges of retaining wall foundations      | sq. yd. | 650    |      |   |   |    |
| 59   | Close boarded shuttering to faces of retaining wall stems both faces measured | sq. yd. | 3,800  |      |   |   |    |
|      | Extra only over last for forming outer face to batter                         | sq. yd. | 1,900  |      |   |   |    |
|      | Carried forward   |         |        |      | £ |   |    |

## REINFORCED CONCRETE BRIDGES

| Item | Particulars  | Unit              | Quant. | Rate | £ | s. | d. |
|------|--|-------------------|--------|------|---|----|----|
|      |  | Brought forward : |        |      |   |    |    |
| 60   | Extra only over Item 59 for forming 2-in. and 4-in. horizontal set-backs on the outer face and forming smooth and true to line   | lin. yd           | 700    |      |   |    |    |
| 61   | Extra only over Items 59 and 60 for weather boarding in lieu of close boarded shuttering   | sq. yd            | 1,350  |      |   |    |    |
| 62   | Extra only over Items 58 and 59 for curved work on plan  | sq. yd.           | 4,450  |      |   |    |    |
| 63   | Extra only over Item 59 for forming 18-in. by 18-in. horizontal splays at base of stem   | lin. yd           | 180    |      |   |    |    |
| 64   | Ditto all as last by 15 in. by 15 in   | lin yd            | 80     |      |   |    |    |
| 65   | Ditto for forming face of butt joint of vertical expansion joint in retaining walls, width of face varying from 12 in. to 24 in., and include for forming $\frac{1}{2}$ -in. by $\frac{1}{4}$ -in. chamfer on exposed vertical edge of joint (joint filling measured separately) | lin. ft           | 375    |      |   |    |    |
| 66   | Ditto for forming 10-in. projections 20 in. wide on inner face of retaining walls at expansion joints and forming thereby 8-in. by 4-in. slot  | lin. ft           | 112    |      |   |    |    |
| 67   | Rough boarded shuttering to concealed vertical faces of abutments within cofferdams  | sq. yd.           | 250    |      |   |    |    |
| 68   | Ditto to sloping backs of abutments  | sq. yd.           | 220    |      |   |    |    |
| 69   | Extra only over Item 67 for forming front face to batter   | sq. yd.           | 90     |      |   |    |    |
| 70   | Close boarded shuttering to exposed vertical faces of abutments within cofferdams  | sq. yd.           | 60     |      |   |    |    |
| 71   | Ditto to all vertical faces to walls and pilasters   | sq. yd.           | 625    |      |   |    |    |
| 72   | Extra only over Item 71 for forming outer face to batter   | sq. yd            | 325    |      |   |    |    |
| 73   | Ditto for forming splayed feature on each pilaster at springing level  | lin. ft.          | 140    |      |   |    |    |
| 74   | Forming mitres to last   | No.               | 8      |      |   |    |    |
| 75   | Extra only over Item 71 for forming wing walls to curve on plan  | lin. yd.          | 45     |      |   |    |    |
| 76   | Ditto for providing approved lining to shuttering at splayed portion at base of main pilasters   | sq. yd.           | 45     |      |   |    |    |
| 77   | Ditto for forming 18-in. by 18-in. horizontal and vertical splays at junction of retaining wall stems and abutment block and cross walls   | lin. ft.          | 180    |      |   |    |    |
| 78   | Close boarded shuttering to transverse cavity retaining walls over abutments (twin walls; three faces measured for shuttering)   | sq. yd.           | 600    |      |   |    |    |
| 79   | Extra only over last for forming one face to batter  | sq. yd.           | 190    |      |   |    |    |
| 80   | Ditto for forming 1-in. cavity between twin walls (joint-filling material measured separately)   | sq. yd.           | 190    |      |   |    |    |
|      |  | Carried forward : |        |      | £ |    |    |

TYPICAL BILLS OF QUANTITIES

| Item | Particulars  | Unit            | Quant. | Rate | £ | s. | d. |
|------|--|-----------------|--------|------|---|----|----|
| 81   | Allow for all necessary propping, scaffolding, staging, and supports to shuttering for reinforced concrete skew barrel arch, including for all timber piles, struts, sole-pieces, wedges, bolts, etc., necessary to provide a thoroughly rigid and unyielding support for the arch during construction and maturing and include for maintenance and removal as directed (the shuttering for the arch is measured separately) | Brought forward |        |      |   |    |    |
| 82   | Close boarded dressed curved shuttering to soffit of arch slabs including for forming to skew  | sum             |        |      |   |    |    |
| 83   | Ditto all as last but to top face of arch slab (two-thirds only assumed necessary to shutter)  | sq yd           | 500    |      |   |    |    |
| 84   | Close boarded shuttering to sides of 10-in cross ribs over arch  | sq yd           | 200    |      |   |    |    |
| 85   | Ditto but 9-in.  | sq. yd          | 190    |      |   |    |    |
| 86   | Ditto but to 18-in. transverse up-stands   | sq. yd.         | 40     |      |   |    |    |
| 87   | Extra only over last for forming one face to batter<br>(Note : Since the work in Items 84 to 87 and Item 95 is cellular, it may not be possible to withdraw all the shuttering. The Contractor is therefore deemed to have included in his price for any shuttering approved by the Engineer to be left in position)   | sq. yd          | 20     |      |   |    |    |
| 88   | Close boarded shuttering to faces of 9-in. spandrel walls including for forming to line of arch  | sq yd.          | 340    |      |   |    |    |
| 89   | Extra only over last for forming to curve on plan  | sq. yd.         | 340    |      |   |    |    |
| 90   | Ditto for forming arch ring to project 2 in. from face of spandrel wall and include for accurately following the contour of the arch barrel and for providing an approved lining for the shuttering to produce a smooth finish   | sq yd           | 30     |      |   |    |    |
| 91   | Ditto for forming 9-in. by 9-in. horizontal and vertical splays at junction of spandrel walls and deck slab and arch slab  | lin ft          | 1,500  |      |   |    |    |
| 92   | Close boarded shuttering to continuous moulded stringcourse 14 in. deep and projecting 6 in. at head of approach retaining walls and spandrel walls  | lin. yd         | 360    |      |   |    |    |
| 93   | Extra over last for providing approved lining to shuttering of outer vertical face to leave a smooth finish  | lin yd.         | 360    |      |   |    |    |
| 94   | Form mitres to stringcourse at pilasters   | No              | 16     |      |   |    |    |
|      | Carried forward :  |                 |        |      | £ |    |    |

## REINFORCED CONCRETE BRIDGES

| Item | Particulars  | Unit              | Quant | Rate | £ s. d. |    |    |
|------|--|-------------------|-------|------|---------|----|----|
|      |  |                   |       |      | £       | s. | d. |
|      |  | Brought forward : |       |      |         |    |    |
| 95   | Close boarded shuttering to soffit of 11-in. deck slab including for forming to super-elevation, etc (net measurement) | sq yd             | 290   |      |         |    |    |
| 96   | Ditto to vertical 9-in face of last for in-situ kerb and include for forming to curve                                  | lm ft             | 150   |      |         |    |    |
| 97   | Form 8½-in. wide recess ¾ in deep in top of deck slab at transverse expansion joints over abutments                    | lin. ft           | 100   |      |         |    |    |

## REINFORCEMENT.

|     |   |      |       |  |  |  |  |
|-----|---|------|-------|--|--|--|--|
| 98  | Provide, cut (if necessary), straighten (if necessary), bend, clean, and fix in position with tying wire as specified, mild steel plain round bar reinforcement in accordance with drawings, bar schedules, and other instructions, ¾ in. diameter and over in lengths not exceeding 40 ft. in piles, retaining walls, abutments, bridges and elsewhere | cwt  | 4,200 |  |  |  |  |
| 99  | Ditto all as last but ½-in. diameter  | cwt. | 1,170 |  |  |  |  |
| 100 | Ditto ditto ¾ in. diameter  | cwt. | 465   |  |  |  |  |

## IN SITU CONCRETE.

|     |  |                   |        |  |  |  |  |
|-----|--|-------------------|--------|--|--|--|--|
| 101 | Concrete quality D in 2-in blinding layer under retaining wall foundations   | sq yd.            | 925    |  |  |  |  |
| 102 | Ditto 6 in. thick under abutments within cofferdams  | sq yd             | 275    |  |  |  |  |
| 103 | Concrete quality A in reinforced base slabs and beams of retaining walls, including transverse steps at change in level, and include for simultaneously casting 18-in. height of wall stem and adjacent 18-in. by 18-in. splay | cu. ft.           | 23,500 |  |  |  |  |
| 104 | Ditto in stems of retaining walls of varying thickness but not less than 12 in. thick, and include thickenings at expansion joints   | cu. ft.           | 31,100 |  |  |  |  |
| 105 | Ditto in unreinforced abutments within cofferdams  | cu yd.            | 1,000  |  |  |  |  |
| 106 | Concrete quality B in reinforced abutments at arch springings  | cu. ft            | 2,500  |  |  |  |  |
| 107 | Concrete quality A in reinforced abutment wing walls and pilasters not less than 21 in. thick  | cu ft             | 7,600  |  |  |  |  |
| 108 | Concrete quality B in reinforced arch slab of 17-in. thickness at crown increasing to 30-in. at springing  | cu. ft.           | 7,500  |  |  |  |  |
| 109 | Concrete quality A in reinforced transverse retaining walls over abutments 16 in. thick  | cu. ft.           | 4,200  |  |  |  |  |
| 110 | Ditto in cross ribs not less than 9 in thick including 9-in. by 9-in. splays   | cu. ft.           | 1,700  |  |  |  |  |
| 111 | Ditto in 9-in. spandrel walls including 2-in. projection of arch ring  | cu. ft.           | 1,750  |  |  |  |  |
|     |  | Carried forward : |        |  |  |  |  |



TYPICAL BILLS OF QUANTITIES

477

| Item | Particulars   | Unit            | Quant. | Rate | £  | s. | d. |
|------|---|-----------------|--------|------|----|----|----|
|      |   | Brought forward |        |      |    |    |    |
| 112  | Ditto in 11-in deck slab including extra thickness under footpaths and for forming to fall to conform to super-elevation, etc.  | cu ft           | 3,050  |      |    |    |    |
| 113  | Ditto in continuous moulded string-course 14 in deep projecting 6 in. along top of spandrel walls and approach retaining walls  | cu ft           | 1,875  |      |    |    |    |
| 114  | Float smooth with 1:2 cement mortar the top horizontal surface of retaining walls including for accurately grading to lines and levels given on drawings and leave prepared to receive parapet wall | sq ft           | 1,475  |      |    |    |    |
| 115  | Concrete quality D in continuous backing to kerbs   | cu yd           | 60     |      |    |    |    |
| 116  | Allow provisional sum of eighty-five pounds for new concrete stairs from new road down to existing house  | sum             |        |      | 85 |    |    |

PRECAST CONCRETE (EXCLUDING PILES).

|     |   |          |       |  |  |  |  |
|-----|---|----------|-------|--|--|--|--|
| 117 | Provide and lay as specified precast concrete kerbs to large radius   | lin. yd. | 025   |  |  |  |  |
| 118 | Extra only over last for kerbs laid to approximately 15-ft. radius  | lin yd   | 70    |  |  |  |  |
| 119 | Provide and lay as specified precast concrete flags for footpaths over bridge   | sq. yd   | 225   |  |  |  |  |
| 120 | Ditto precast blocks in 12-in. parapet and at pilasters   | cu ft    | 2,050 |  |  |  |  |
| 121 | Ditto precast parapet coping slabs  | cu ft    | 350   |  |  |  |  |
| 122 | Ditto over pilasters  | No       | 30    |  |  |  |  |
| 123 | Extra only over Items 120 to 122 for pointing both faces of parapet, pilasters, and coping as specified   | sq. yd   | 650   |  |  |  |  |
| 124 | Extra only over Items 121 and 122 for providing and fixing ½-in. diameter copper dowels 5 in. long between each coping slab and include for cutting neatly 3-in diameter holes 2½ in. deep at each end of each coping slab and filling with 1:2 cement mortar | No.      | 180   |  |  |  |  |

EXPANSION JOINTS.

|     |  |                  |     |  |   |  |  |
|-----|--|------------------|-----|--|---|--|--|
| 125 | Provide and fix in shuttering at time of constructing retaining walls, ½-in approved resilient expansion joint filler; width of face of joint varies from 12 in. to 24 in. | lin. ft.         | 375 |  |   |  |  |
| 126 | Seal vertical slot 8 in. by 4 in. at expansion joints in retaining walls with stiff mortar consisting of equal parts of cement and sand                                    | lin ft           | 365 |  |   |  |  |
| 127 | Provide and fix with 2-in. copper nails 7 lb. sheet lead wrapped 4 in round each face of expansion joint in retaining walls; total girth 9 in.                             | lin. ft.         | 365 |  |   |  |  |
|     |  | Carried forward: |     |  | £ |  |  |

## REINFORCED CONCRETE BRIDGES

| Item | Particulars   | Unit              | Quant. | Rate | £ | s. | d. |
|------|---|-------------------|--------|------|---|----|----|
|      |   | Brought forward : |        |      |   |    |    |
| 128  | Provide and fix by sweating on to back face of retaining walls at expansion joints $\frac{1}{2}$ -in. bituminous sheeting 3 ft. 6 in. wide  | sq. yd.           | 140    |      |   |    |    |
| 129  | Provide and fix in transverse cavity walls over abutments, 1-in. approved resilient expansion joint filler including for fixing to face of retaining walls with 2-in. copper nails  | sq. yd.           | 190    |      |   |    |    |
| 130  | Provide and fix with 2-in. copper nails 7 lb. sheet lead wrapped 4 in round each exposed vertical edge of expansion joints at pilasters; total girth, 9 in.   | lin. ft.          | 40     |      |   |    |    |
| 131  | Provide and fix complete flush with top of concrete slab, $\frac{3}{4}$ -in. mild steel plate 8 in. wide covering expansion joints in deck slab over abutments, including for fixing on one side of joint only by $\frac{3}{4}$ -in. countersunk steel bolts embedded in the concrete at 15-in. centres | lin. yd.          | 35     |      |   |    |    |
| 132  | Provide and fill approved bituminous compound into space $\frac{1}{2}$ in. wide and $\frac{1}{4}$ in. deep at expansion joints in deck slab   | lin. yd.          | 35     |      |   |    |    |

## FINISHES.

|                                       |   |         |       |  |   |  |  |
|---------------------------------------|---|---------|-------|--|---|--|--|
| 133                                   | Bush hammer all exposed faces of approach retaining walls excluding stringcourse  | sq. yd. | 1,600 |  |   |  |  |
| 134                                   | Ditto of spandrel walls and pilasters, excluding arch ring, stringcourse and splayed feature at springing level             | sq. yd. | 500   |  |   |  |  |
| 135                                   | Wire brush exposed surfaces of parapet and coping to present a uniform appearance and expose the special "glitter" material | sq. yd. | 750   |  |   |  |  |
| Total of Section E carried to Summary |   |         |       |  | £ |  |  |

TYPICAL BILLS OF QUANTITIES

**Section F.—Roads and Pavings.**

*Note :* The rates for road and footpath surfacings are to include for making good up to kerbs, gullies, manholes, and the like. No deduction is made from the measurements for manholes, gullies, and the like. Kerbs and flags are included in Section E.

| Item                                  | Particulars   | Unit    | Quant. | Rate | £ | s. | d. |
|---------------------------------------|---|---------|--------|------|---|----|----|
| 136                                   | Scarify and break up surface of existing carriageway at ends of new approach roads and elsewhere as directed, and lay aside scarified material for re-use as directed | sq yd   | 1,350  |      |   |    |    |
| 137                                   | Provide and prepare as specified formation to new approach roads  | sq yd.  | 4,650  |      |   |    |    |
| 138                                   | Ditto to road over bridge   | sq. yd. | 85     |      |   |    |    |
| 139                                   | Ditto to footpaths  | sq. yd. | 2,025  |      |   |    |    |
| 140                                   | Provide, lay, and blind as specified bottom course of whinstone pitching to approach roads and road over bridge   | sq yd.  | 4,750  |      |   |    |    |
| 141                                   | Provide, lay, and blind hard-core bottoming for footpaths as specified  | sq yd   | 2,025  |      |   |    |    |
| 142                                   | Provide and lay 3-in. consolidated thickness of bituminous macadam as specified in bottom layer of surfacing to approach roads  | sq yd.  | 4,675  |      |   |    |    |
| 143                                   | Maintain last for twelve months as specified and make good  | sq. yd. | 4,675  |      |   |    |    |
| 144                                   | Provide and lay after expiry of twelve months 2-in. consolidated thickness of bituminous macadam as specified for top layer of surfacing to approach roads            | sq. yd  | 4,675  |      |   |    |    |
| 145                                   | Provide and lay 1½-in consolidated thickness of bituminous macadam as specified for footpaths of approach roads   | sq yd   | 1,985  |      |   |    |    |
| 146                                   | Provide and lay 3-in. consolidated thickness of single coat hot-process asphalt as specified for road over bridge   | sq. yd  | 435    |      |   |    |    |
| Total of Section F carried to Summary |   |         |        |      | £ |    |    |

**Section G.—Sundries.**

| Item                                  | Particulars  | Unit     | Quant. | Rate | £  | s. | d. |
|---------------------------------------|--|----------|--------|------|----|----|----|
| 147                                   | Provide and erect post and wire fence complete as specified  | lin. yd. | 395    |      |    |    |    |
| 148                                   | Allow P.C. sum of twenty-five pounds for supply of bronze engraved tablet and add for taking delivery, setting, and fixing to parapet and for profit | sum      |        |      |    |    |    |
| 149                                   | Allow provisional sum of twenty pounds for testing materials   | sum      |        |      | 20 |    |    |
| 150                                   | Allow provisional sum of fifty pounds for constructing road blocks and other works at ends of existing bridge  | sum      |        |      | 50 |    |    |
| Total of Section G carried to Summary |  |          |        |      | £  |    |    |

**Summary.**

Sums brought forward from Bills of Quantities  
 £ s d.

|   |  |
|---|--|
| SECTION A--Preliminaries . . . . .                    |  |
| .. B--Clearing site, excavation and filling . . . . . |  |
| .. C--Drains . . . . .                                |  |
| .. D--Piling . . . . .                                |  |
| .. E--Concrete and reinforced concrete . . . . .      |  |
| .. F--Roads and pavings . . . . .                     |  |
| .. G-- Sundries . . . . .                             |  |

The Contractor is to enter here a sum for any and every work, materials, labour, plant, service, or other matter which he may consider necessary for the due and proper completion of the Works in accordance with the full intent of the Contract Documents and for which he has not included in one or more of the preceding items of the Bill of Quantities, and a description of such work, etc., shall be entered here . . . . .

Allow for lithography or copying Bill of Quantities the sum of twenty pounds. 20 - -

Total . . . . . £

Allow for contingencies a sum equal to ten per cent. of the foregoing total, which sum shall be at the absolute disposal of the Engineer and shall be deducted in part or in whole as directed . . . . .

Net amount of tender carried to Form of Tender . . . . . £

**Schedule of Prices.**

**MATERIALS**— Quality to be as specified and rates are to include for delivery to position required on the site

|  | Unit    | Rate |
|--|---------|------|
| Ordinary Portland cement . . . . .   | ton     |      |
| Rapid-hardening Portland cement . . . . .  | ton     |      |
| High-alumina cement . . . . .  | ton     |      |
| <i>Note</i> ---In the event of the Contractor being directed to use high-alumina cement, the prices given against the appropriate items for concrete in the Bill of Quantities will be adjusted only by the net difference in the cost of the cement based on the rates quoted in this Schedule. |         |      |
| <b>Fine Aggregate :</b>  |         |      |
| Source of fine aggregate proposed to be used by the Contractor to be stated here . . . . .   |         |      |
|  | cu. yd. |      |
| <b>Coarse aggregate :</b>  |         |      |
| Source of coarse aggregate proposed to be used by the Contractor to be stated here . . . . .   |         |      |
|  | cu. yd. |      |
| Timber left in as directed . . . . .   | cu. ft. |      |

## TYPICAL BILLS OF QUANTITIES

.481

|   | Unit | Rate |
|---|------|------|
| <p><b>DAYWORK.</b>— No payment additional to the rates quoted herein will be allowed for foremen, time-keeper, head-office charges, or for the use of scaffolds, tackle, tools, or for sharpening tools. Time on fixing and removing scaffolds will be allowed.</p> |      |      |
| Labourer . . . . .  | hour |      |
| Labourer engaged on concreting . . . . .  |      |      |
| Concrete mixer operator . . . . .   |      |      |
| Carpenter . . . . .   |      |      |
| Steel bender and fixer . . . . .  |      |      |
| Timberman . . . . .   |      |      |
| Mason or bricklayer setting precast units . . . . .   |      |      |
| 5-ton lorry and driver . . . . .  |      |      |
| 5-ton crane and driver . . . . .  |      |      |
| 10-ton road roller, scarifier, and driver . . . . .   |      |      |
| 6-ton road roller, scarifier, and driver . . . . .  |      |      |

NOTE It is recommended that Appendixes I, II, and III be read in conjunction with the following Ministry of Transport publications, all of which may be obtained from H.M. Stationery Office. (a) Standard Forms, Conditions of Tender and Contract for Road and Bridge Works. (b) Specification for Road and Bridge Works. (c) Notes on the Preparation of the Bill of Quantities, Part Two of the Schedule to Standard Forms, Conditions of Tender and Contract for Road and Bridge Works. With reference to (a) it should be noted that the contents apply to England and Wales. Certain modifications are required for use in Scotland.

## APPENDIX IV

### PRICES OF MATERIALS AND WAGES IN 1955

THE following data are from "Concrete and Constructional Engineering", September, 1955, and relate to materials delivered in London and to the wages current in London. It is given for the purpose of comparison with prices at other times so that estimates of costs given in Chapters XII and XIII can be approximately adjusted.

#### Materials.

AGGREGATES (per cu. yd). Washed sand, 25s. 1*d* Clean shingle:  $\frac{3}{4}$  in., 21s. 5*d*. ;  $\frac{1}{2}$  in., 24s. Pit ballast, 24s 6*d*.

CEMENT (per ton, delivered at Charing Cross). Portland cement, 6 tons and upwards, 101s 6*d*. 1 ton to 6 tons, 113s. 6*d*. Paper bags and non-returnable jute sacks included. Rapid-hardening Portland, 10s. 6*d*. above ordinary Portland. High-alumina cement: per ton, 307s.; 2 tons, at 296s. 9*d*. , 4 tons, at 291s. 9*d*. ; 6 tons, at 288s. 3*d*.

SHUTTERING. 1-in and 1 $\frac{1}{4}$ -in. deal sawn shuttering, £95-£100 per standard (165 cu. ft.).

REINFORCEMENT. Mild steel bars (per cwt.):  $\frac{5}{8}$  in. to 2 $\frac{7}{8}$  in., 45s. 9*d*. ;  $\frac{9}{16}$  in. to  $\frac{1}{2}$  in., 47s. 6*d*. ;  $\frac{3}{8}$  in., 48s. 3*d*. ;  $\frac{1}{4}$  in., 49s. 9*d*.

#### Wages.

Carpenters and joiners, 4s. 1 $\frac{1}{2}$ *d*. per hour (carpenters 2*d*. a day tool money), labourers, 3s. 7*d*. ; men on mixers and hoists, 3s. 10*d*. ; bar-benders, 3s. 10 $\frac{1}{2}$ *d*.

#### Prices of Materials and Rates of Wages in 1939.

Below is an abridged list of comparable prices and rates ruling in 1939. This is given to show the increases which have taken place since that date and will enable some comparison to be made between pre-war and post-war costs should this be required.

MATERIALS.—Washed sand, 8s. 3*d*. per cubic yard ;  $\frac{3}{4}$ -in. gravel aggregate, 7s. 3*d*. per cubic yard ; all-in aggregate, 7s. 3*d*. per cubic yard.

Portland cement delivered in 4-ton loads and upwards, 42s per ton ; rapid-hardening Portland cement, 6s. per ton extra.

Wrought boards for shuttering : 1 in. thick, 23s. per square (100 sq. ft.) ; 1 $\frac{1}{4}$  in., 28s 6*d* per square. Sawn timber 3 in. by 4 in. to 3 in. by 7 in., £22 to £22 10s. per standard (165 cu. ft.).

Mild steel bars for reinforcement :  $\frac{5}{8}$  in. and upwards, 15s. 9*d*. per cwt. ;  $\frac{1}{2}$  in., 16s. 3*d*. per cwt. ;  $\frac{3}{8}$  in., 16s. 9*d*. per cwt. ;  $\frac{1}{4}$  in., 17s. 9*d*. per cwt.

WAGES.—Carpenters and joiners, 1s. 9*d*. per hour ; if working on old shuttering, 1s. 10*d*. an hour. Labourers, 1s. 3 $\frac{3}{4}$ *d*. per hour ; men on concrete mixers and hoists, 1s. 4 $\frac{3}{4}$ *d*. per hour ; bar-benders, 1s. 5 $\frac{3}{4}$ *d*. per hour.

## APPENDIX V

### EXAMPLES OF REINFORCED CONCRETE BRIDGES

In the following pages examples of reinforced concrete bridges of some of the types described in Chapter III are illustrated and briefly described. The references to types relate to *Figs. 22 to 39*. The structures illustrated have been selected for their engineering features and not necessarily for their aesthetic qualities. The bridges described in the previous chapters also illustrate the application and design of the various basic types and variations thereof.

## REINFORCED CONCRETE BRIDGES

### GIRDER BRIDGES.

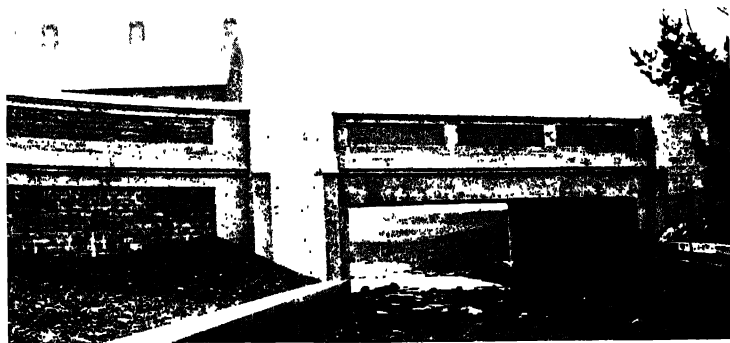

Fig. 338.—Elevation.

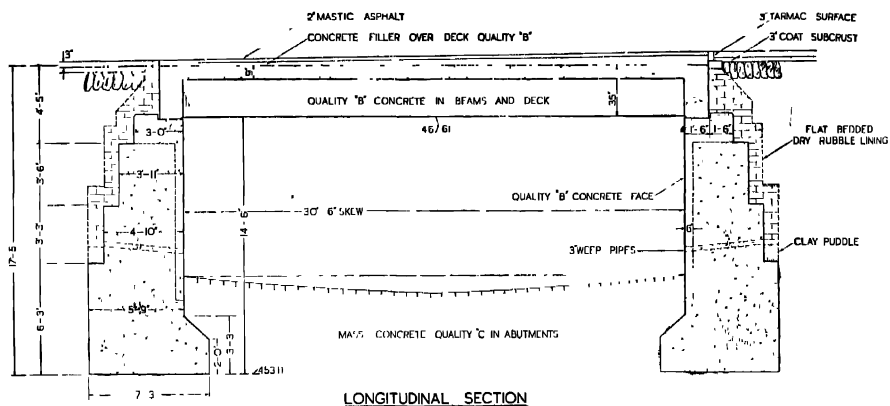

Fig. 339.—Longitudinal Section.

#### LONG PRESTON BRIDGE.

This is a typical simple single-span beam-and-slab construction (Type 1, *Fig. 22*) applied to a bridge having a skew span of 30 ft. 6 in. Although generally such construction is not used for spans exceeding, say, 40 ft., there are a few cases of bridges with much larger spans, such as that over the tidal basin entrance, Royal Docks, London, a diagram of which is given in *Fig. 347*. The longitudinal girders are 8 ft. 2 in. deep and the effective span is 103 ft. 6 in.

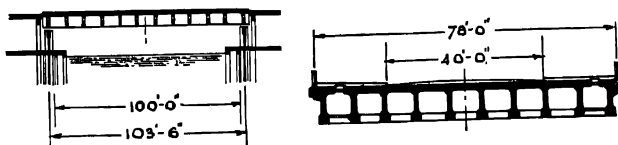

Fig. 340.—Bridge at Royal Docks, London.



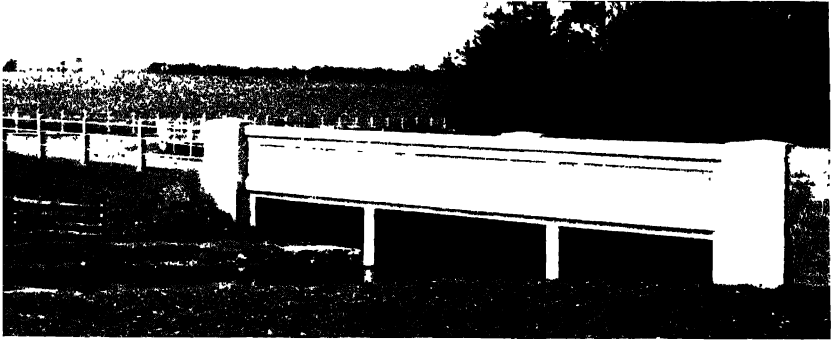

Fig. 341.—Elevation.

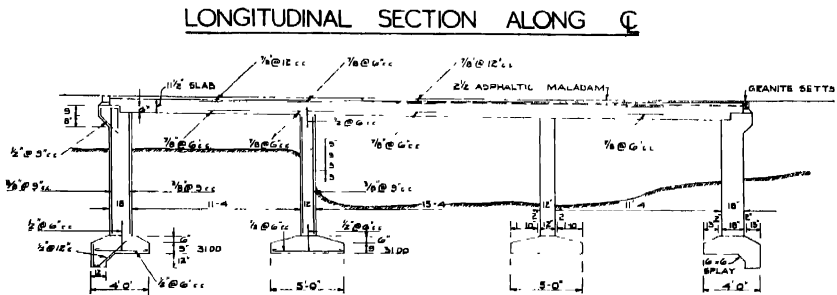

Fig. 342.—Longitudinal Section.

## BRIDGE AT KIRKSMEATON, YORKSHIRE.

This bridge is of multiple-span slab construction (Type 2, *Fig. 23*). The spans are arranged in the ratio of 1 : 1.3 : 1 to equalise approximately the positive and negative bending moments. A feature of the structure, which carries a 20-ft. road and two 5-ft. footpaths, is that the levels of the slab conform to the superelevation of the road.

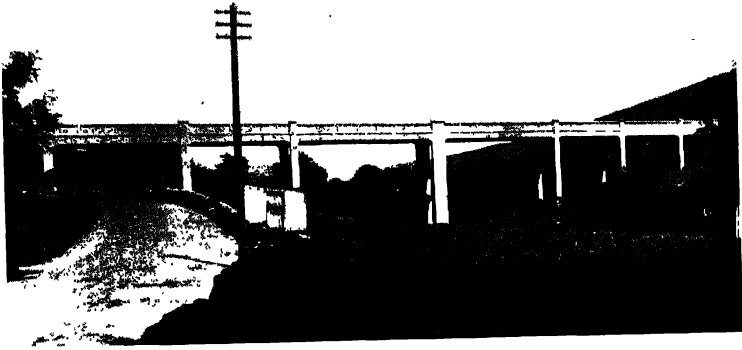

Fig. 343.—Edale Viaduct, Hope, Derbyshire.

This is of multiple-span continuous beam-and-slab construction (Type 2, *Fig. 23*). It carries a single line of railway, and two of the eight spans are 61 ft. 6 in., one 43 ft., three 40 ft., and two 26 ft. 6 in. The deck is 13 ft. wide and is supported on longitudinal girders under the rails and cross beams carried by the parapet girders. Near the middle of the bridge there is an expansion joint and a double supporting trestle.

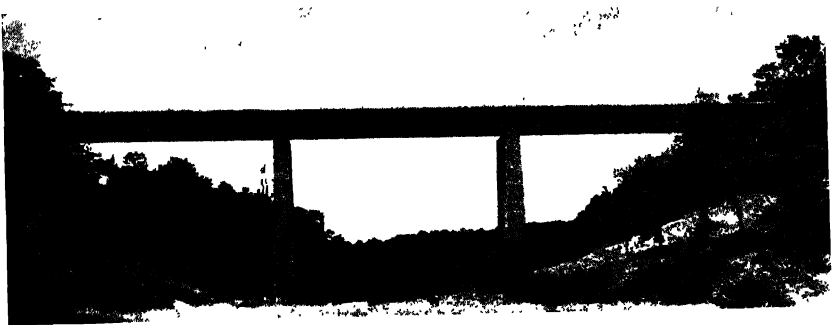

Fig. 344.—A Three-span Viaduct, Hungary.

This is a variation of type No. 2. The main beams are 83 ft. long, 1 ft. 4 in. wide, and 8 ft. 3 in. deep, and were precast and lifted on to the piers.

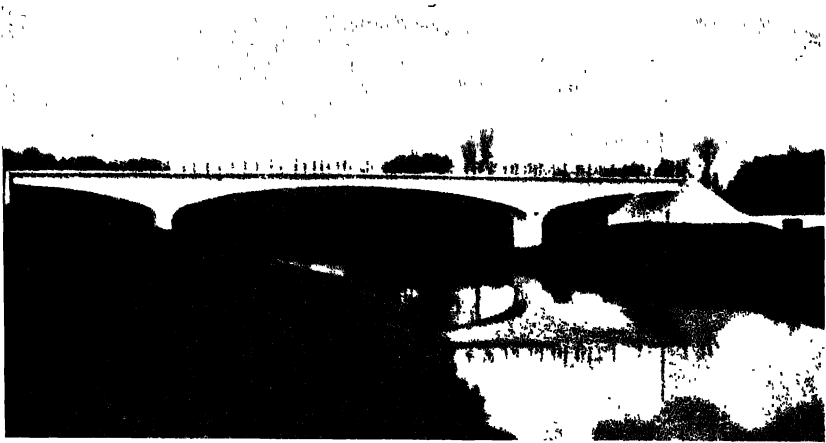

Fig. 345.—Elevation.

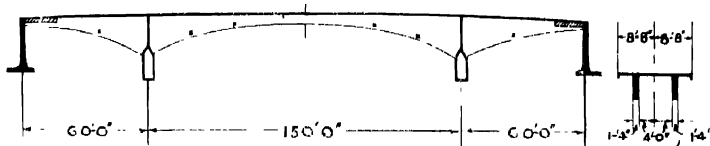

Fig. 346. Longitudinal Section.

## ALVELEY BRIDGE OVER THE RIVER SEVERN

This bridge, which was constructed in 1937, carries two coal-tub roads and a footpath. For dead load it is designed as a beam continuous over three spans (Type No. 5, *Fig. 26*), but it is designed as an arch for superimposed load. The depth of the girders at mid-span is 5 ft, increasing to 18 ft. 5 in. at the supports.

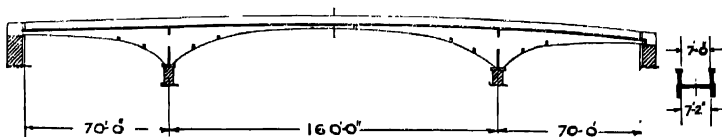

Fig. 347.—Footbridge over River Forth, Stirling.

Completed in 1935, this bridge was designed as a single-span double-cantilever structure (Type No. 7, *Fig. 28*) for dead load, and as a continuous girder (Type No. 5, *Fig. 26*) for superimposed load. The depth of the parapet girders at midspan is 6 ft., increasing to 22 ft. 4 in. at the supports.

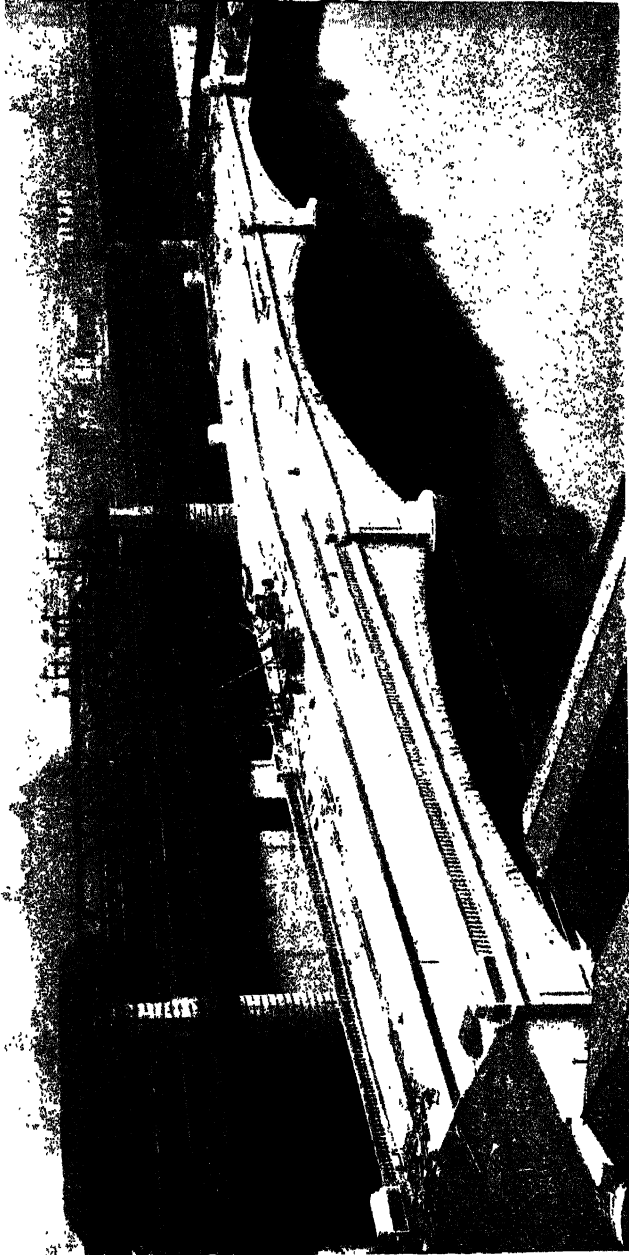

Fig. 348.—King George V Bridge, Glasgow.

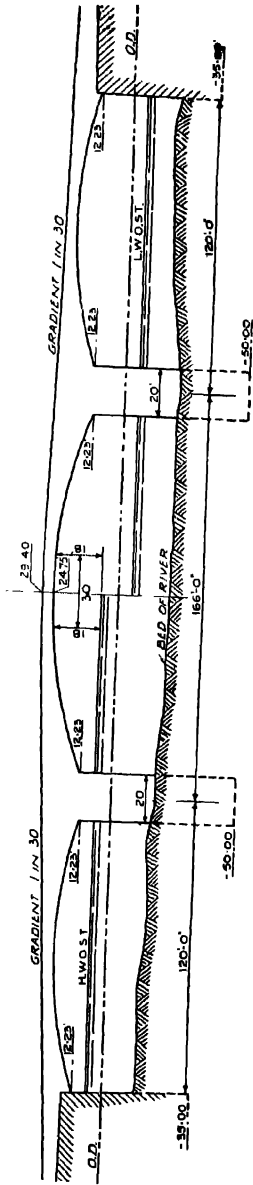

Fig. 349.—King George V Bridge, Glasgow : Longitudinal Section.

This bridge, completed in 1927, consists of a central span of 166 ft. and two end spans of 120 ft. each. The construction is similar to Type No. 5 (Fig. 26), but with roller bearings at the seatings of the cellular longitudinal girders. The depth of the latter at mid-span is 4 ft. 8 in.

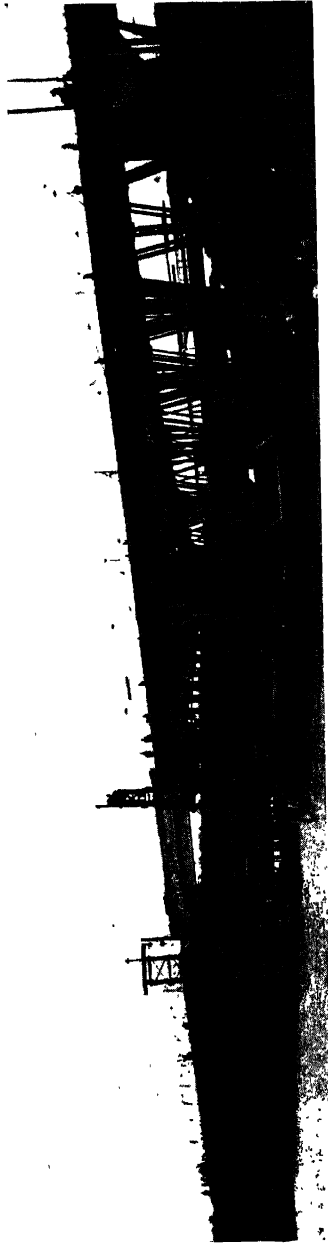
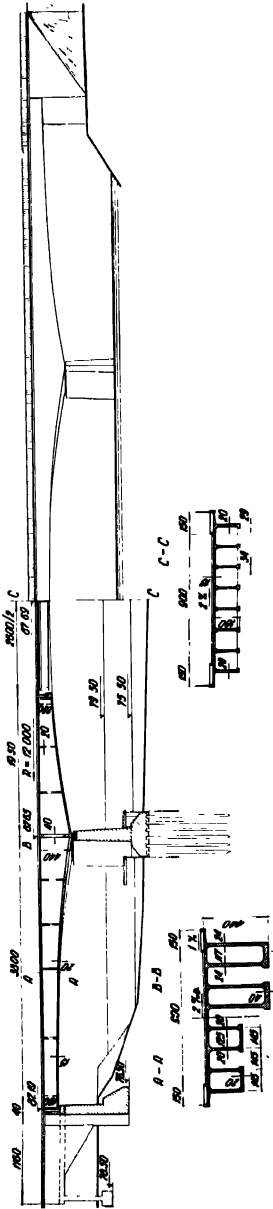

Fig. 350.—Bridge over the River Bosut, Yugoslavia.

This is a cantilevered bridge with a central suspended precast span. The depth of the eight central I-beams is 5 ft. 11 in. and they are 85 ft. 5 in. long and weigh 25 tons each. The end beams, with cantilevers, consist of four box-sections. In the middle of the end spans, in the cantilevered parts, and in the middle of the suspended girder there are rigid transverse beams



Fig. 351.—Elevation from Upstream (see also Fig. 352).

WATERLOO BRIDGE, LONDON

The new Waterloo bridge has five girder spans each of approximately 240 ft. clear and is a variation of Type No. 6, Fig. 27, since the middle portion of the central span is a freely-supported girder. The width of the roadway is 58 ft. and there are two footpaths each 11 ft. wide. There are two longitudinal box girders throughout, the latter being 25 ft. wide and subdivided by internal ribs and diaphragms. The deck is supported over the 33-ft. space between the longitudinal girders by cellular transverse girders 7 ft. deep. The depth of the longitudinal girders at the crown is 8 ft.

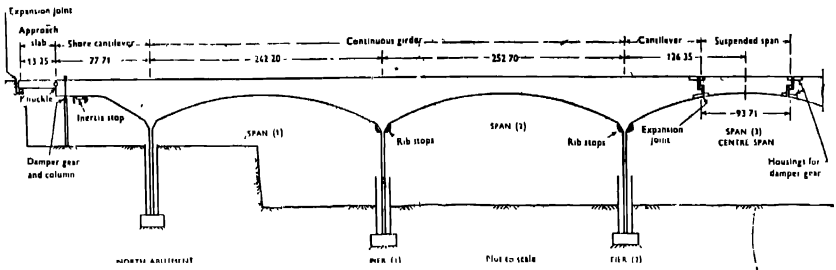

Fig. 352.—Waterloo Bridge, London : Articulation Diagram (see previous page).

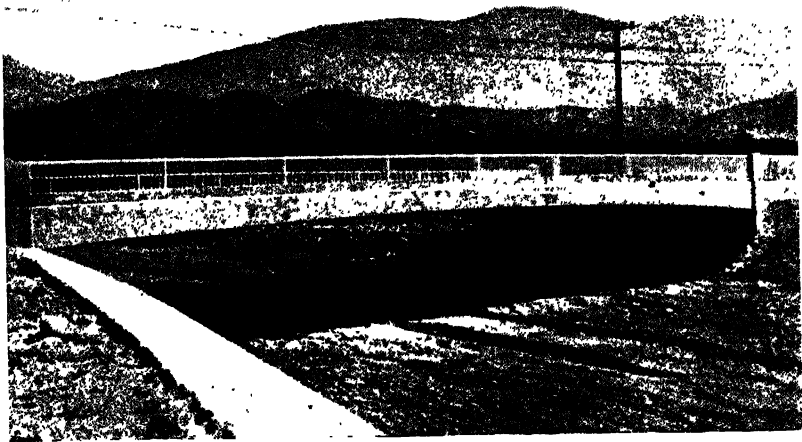

Fig. 353.—Elevation.

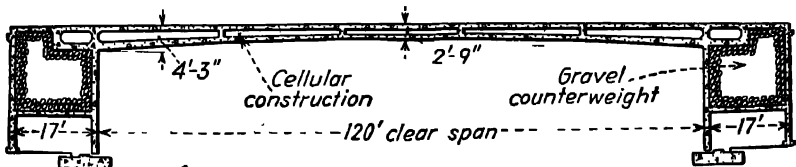

Fig. 354.—Longitudinal Section.

BRIDGE AT SANTA PAULA, CALIFORNIA.

This road bridge, 62 ft. wide and completed in 1941, is of single-span counter-weighted construction analogous to Type No. 7, Fig. 28.





Fig. 355.—Bridge at Villeneuve-St. Georges, France.

This road bridge, which is 46 ft. wide and was completed in 1939, is a modification of Type No. 7, *Fig. 28*, insofar as there is a central span of 255 ft. and two end spans of 134 ft. For a distance of 97 ft. from each of the river piers the girders of the end spans are cantilevers, the remainder of the end spans being freely suspended.

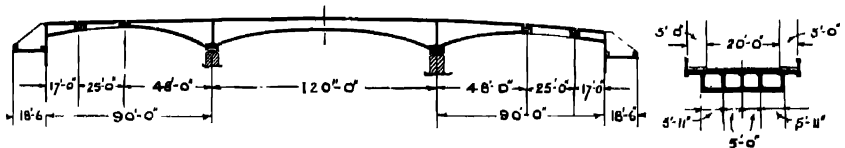

Fig. 356.—Road Bridge at Wiggshall, Norfolk.

This is an adaptation of Types Nos. 6 and 7 (*Figs. 27 and 28*) insofar as the central span and 48-ft. projections of the end spans constitute double cantilever construction, while the remainder of the end spans is provided by a short freely-suspended span supported at the outer ends on cantilevers projecting from the abutments. The depth of the main girders of the central span is 4 ft. 9 in. at the crown and 10 ft. 9 in. at the piers.

## ARCH BRIDGES.



Fig. 357. Deepdene Bridge, Dorking.

This is a typical single-span solid-spandrel fixed barrel arch (Type No. 8, *Fig. 29*). For moderate spans the road is laid on earth filling placed between the spandrel walls.

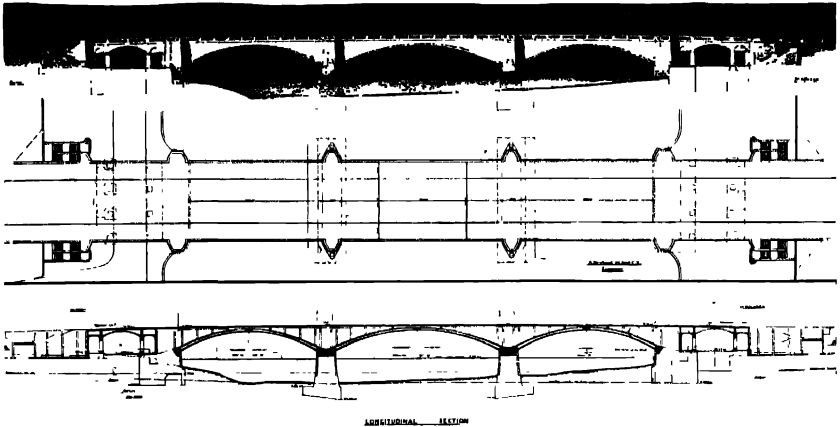

Fig. 358.—Bridge over River Thames at Chiswick.

In this multiple-span solid-spandrel barrel arch (Type No. 8, *Fig. 29*) the deck is supported on columns carried on the arch slab, the latter being of cellular construction. The central span is 150 ft. clear, the two side river spans are each 125 ft. clear, and the spans on each bank are 61 ft. 6 in. The width of the bridge is 70 ft., comprising a roadway 40 ft. wide and two footpaths each 15 ft. wide. The thickness of the arch at the crown is 3 ft., increasing to 4 ft. 8 in. at the springing.



Fig. 359.—Elevation.



Fig. 360. Elevational Diagram.

### Sandö Bridge, Sweden.

The bridge at Sandö, Sweden, is an open-spandrel fixed single-arch rib construction (Type No 9, Fig. 30) and is the longest reinforced concrete arch in the world. Construction was completed in 1943. The span is 866 ft. and the ratio of rise to span is 1 to 6.66. The overall thickness of the arch is 8 ft. 8 in. at the crown and 14 ft. 9 in. at the springing, and the arch is of triple-cellular construction, the top and bottom slabs and the vertical diaphragms being 12 in. thick. The deck carries a 34-ft. roadway and two 4-ft. footpaths, and is supported on columns carried on the arch.

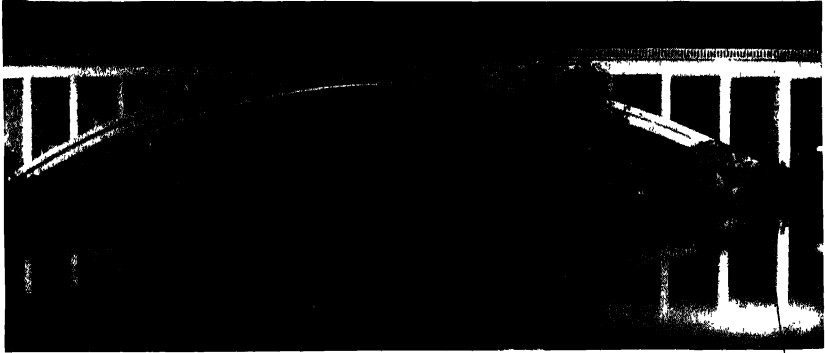

Fig. 361.—Bridge over River Sarthe at Beaumont, France.

This is a three-hinged open-spandrel arch bridge (Types 9 and 10) with a span of 267 ft. and a rise of 37 ft. The columns between the arch and the deck are the full width of the bridge.

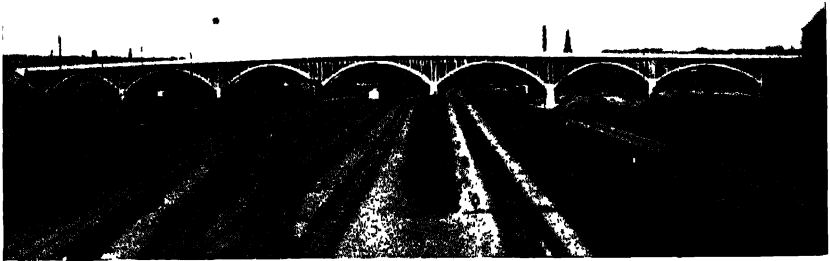

Fig. 362.—Bridge at Aarhus, Denmark.

An open-spandrel multiple-span arch rib structure with three-hinge arches, and therefore one of the variants of Type No. 9, *Fig. 30*.

The seven spans vary in length from 116 ft. to 148 ft. centre to centre, the clear spans being from 99 ft. to 129 ft. The ratio of rise to clear span varies from 1 to 5.2 to 1 to 7.3. At the crown the three-hinged arches are 1 ft. 8 in. to 2 ft. thick at the crown and 2 ft. 4 in. at the springing. The maximum thickness at the quarter-points is 3 ft. 4 in. The deck carries a 37-ft. road, two 6-ft. 6-in. cycle tracks and two 9-ft. 6-in. footpaths.



Fig. 363.—Elevation.

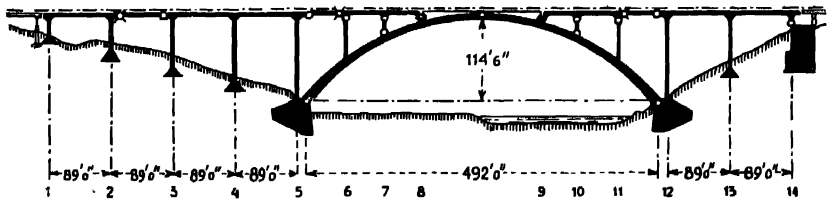

Fig. 364.—Articulation Diagram.

## LORRAINE VIADUCT OVER THE RIVER AAR, SWITZERLAND.

This is a combination of Types Nos. 9 and 10 (*Figs. 30 and 31*), since it consists of a three-hinged arch slab but is of open-spandrel construction. The arch slab is of cellular construction with four longitudinal diaphragms and is 44 ft. wide. The depth at the crown is 10 ft. 6 in. and at the springing 16 ft. 6 in. Based on the theoretical span of 492 ft. the ratio of rise to span is 1 to 4.3. The deck is 57 ft. wide and carries four lines of railways.



**Fig. 365.**—Bridge over River Oise at Conflans, France.

This is an open-spandrel fixed-arch bridge (Type 9) with a span of 330 ft., a rise-span ratio of  $\frac{1}{6}$  and a width of 33 ft. The arch is of rectangular cross-section and is hollow except at the springings.

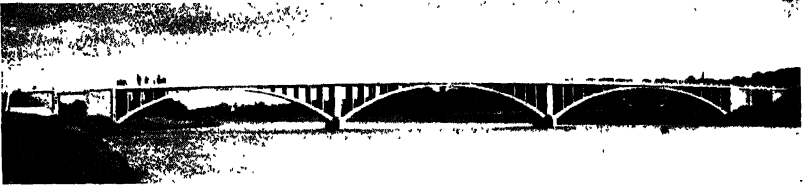

**Fig. 366.** Bridge over River Saône at Tournus, France.

This is an open-spandrel fixed-arch bridge (Type 9) with arches spanning 210 ft., 217 ft., and 210 ft. Width 33 ft. Each span comprises two ribs 11 ft. 6 in. wide spaced 10 ft. apart.

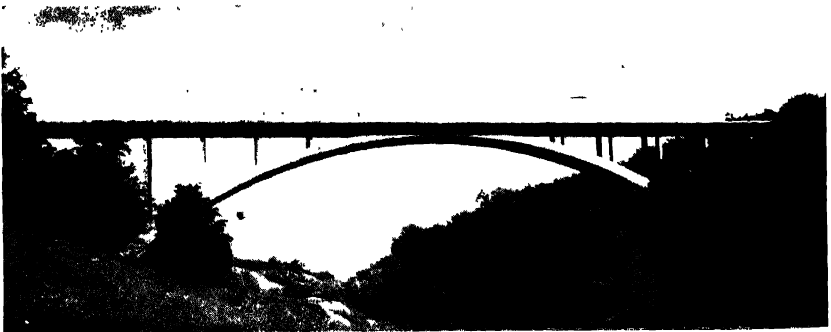

**Fig. 367.** Bridge at Varasd, Hungary.

An open-spandrel fixed-arch bridge (Type 9). Span 325 ft.

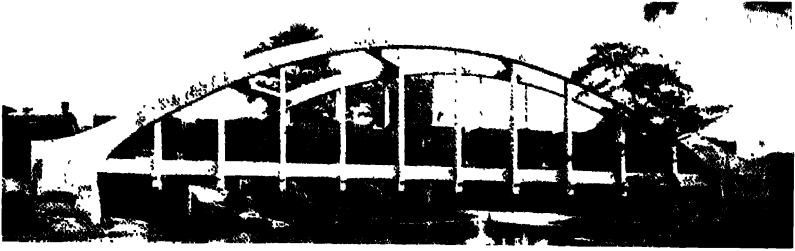

**Fig. 368.**—Esholt Bridge, Yorkshire.

This is a bowstring bridge (Type No. 12, Fig. 33), with a span of 157 ft. The illustration shows the structure under a test load of 252 tons.



**Fig. 369.**—St. Lucien Bridge, Tunisia.

A bowstring girder bridge (Type 12), span 303 ft. Concrete made with high-alumina cement and cured in a waterjacket.

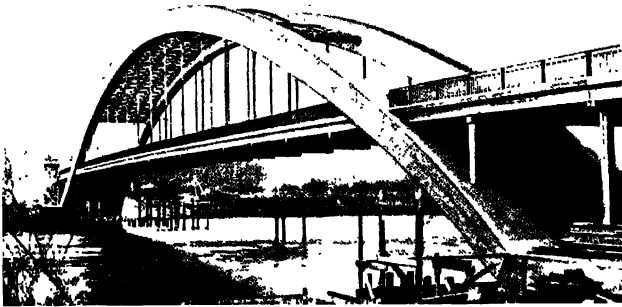

Fig. 370.—Elevation.

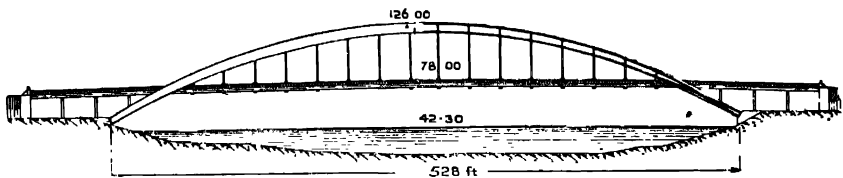

Fig. 371.—Dimensions: Bridge at Roche-Guyon over the River Seine, France.

Completed in 1934, this is of open-spandrel fixed-arch rib construction with the deck partly suspended (Type No. 13, *Fig. 34*). The arch ribs are partly solid and partly cellular and have a span of 528 ft. The ratio of rise to span is 1 to 7. The deck carries an 18-ft. 6-in. road and two footpaths, giving a total width of 32 ft. 9 in.

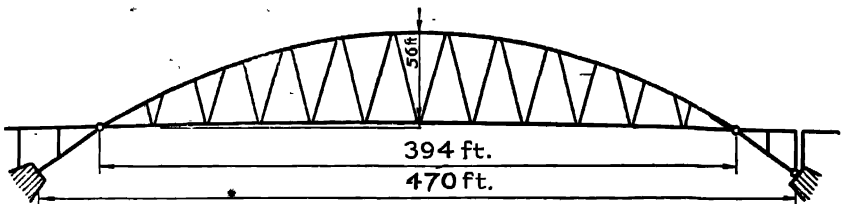

Fig. 372.—Bridge over River Lot at Castlemoron, France.

This is a combination of the previous design and bowstring construction, as hinges are introduced at deck level. The complete span is 470 ft., the ratio of the rise to span for the bowstring portion being 1 to 7. The two arch ribs are each 3 ft. 3 in. wide, 3 ft. 11 in. deep at the crown and 4 ft. 11 in. deep at deck hinge level. The deck provides for an 18-ft. road and two 3-ft. 3-in. footpaths.



# INDEX

- Abutments, Architectural treatment of, 237  
 " Cellular, 229  
 " Mass concrete, 221  
 Admixtures in cement, 450  
 Aesthetics, 2, 7, 48, 234  
 Aggregates, Coarse, 376, 450  
 " Fine, 374, 395, 451  
 Alignment of bridges, 5, 247  
 Ancient bridges, 1  
 ARCHES AND ARCH BRIDGES (See also Bowstring girders):  
 Architectural treatment, 235, 238  
 Design, 169  
 Examples, 188, 494, 500  
 Fixed earth-filled, 179, 299  
 " open-spandrel, 179, 191, 300  
 Jacking, 409  
 Precast, 408  
 Shape, 174, 196, 235  
 Spans, 236  
 Three-hinged earth-filled, 171, 188  
 " " open-spandrel, 178, 209  
 " " unsymmetrical, 174  
 Types, 30, 35  
 Variation of thickness, 185, 195  
 Architectural treatment, 2, 7, 48, 234  
 Asphalt, 453, 464, 479
- Balusters, 242  
 Beams (See also Girders, Cantilevers, and Continuous girders)  
 Beams, Architectural treatment of, 235  
 " Tee-, 86  
 Bearings, 85, 94, 412  
 Bending and thrust combined, 147  
 Blinding, Concrete, 336, 454, 476  
 " road foundations, 452  
 Boring, 12, 427  
 Bowstring girders, 37, 185, 300, 499
- Calculations, 273  
 Cantilevers, 29, 34, 116, 301, 302  
 Cavities, 457  
 Cement, 372, 394, 450  
 " Coloured, 242  
 Centering for arches, 338, 340, 456  
 " Examples of, 341  
 " Quantities for, 473  
 " Removal of, 461  
 Certificates, 422, 435, 442, 343  
 Cofferdams, 198, 335, 454  
 Columns, Architectural treatment of, 235  
 Completion of works, 422, 434  
 CONCRETE AND CONCRETING, 372  
 Bill of quantities, 473  
 Consistency (see Water)  
 Corrosion, 402  
 Curing, 389, 499, 461  
 Distribution, 384, 459  
 In cold weather, 460  
 Mixing, 381, 395, 457  
 Placing, 386, 399, 459  
 Proportioning, 379, 457  
 Quantities for various mixtures, 382  
 Remedying defects, 390  
 Slump test, 458  
 Strength of existing, 266  
 Stresses, 55  
 Supervision, 399  
 Test cubes, 373, 378, 395, 452, 458  
 Under water, 388  
 Water, 378, 383, 395, 452, 457  
 Construction, Methods of and equipment for, 309  
 " Preliminaries to, 309  
 " Programme of, 327, 407  
 Continuous girders, 29, 95, 118  
 " " Estimating cost of, 302  
 " " with fixed points of contraflexure, 116  
 Continuous slabs, 75, 83  
 Contingencies, 296, 440, 482  
 Contours, 1, 5, 48  
 Contract, Alterations to, 437  
 " agreement, 292, 425  
 " Conditions of, 292, 422  
 " documents, 292, 424  
 " price, 321, 423  
 " time, 311, 433  
 Copings, 242, 463  
 Cost estimates, 295, 308, 321, 326  
 " of labour and materials, 482  
 " Prime, 440  
 Culverts, 403  
 Curved bridges, 402
- Damages, 425, 435  
 Daywork, 481  
 Defects, 390, 435  
 Dimensions of bridges, 2, 7  
 Distribution reinforcement, 73  
 Drainage, 22, 417, 454, 471  
 " of abutments, 21  
 " of approach roads, 21  
 Drawings, 2, 67, 270, 287, 423  
 Ducts, Service, 8
- Economy, 9  
 Estimating contract time, 311  
 " cost, 295, 308, 321, 326  
 EXCAVATION, 205, 332  
 Disposal of material, 332  
 Exploratory, 427  
 Quantities, 469  
 Specification, 453  
 Timbering, cofferdams, and dewatering, 335
- Fences, 453, 466, 475  
 Filling, 337, 452, 464  
 " Quantities for, 470  
 Finishes, 242, 243, 288, 461  
 Fixings, 457  
 Floods, 7, 19  
 Footbridges, 409  
 Footpaths, 2, 7, 465, 479  
 Foundations, 41, 197, 336  
 " Design of, 221  
 " Examples of, 204  
 " liable to disturbance, 44  
 (See also Ground)

- Gases on concrete, Effect of, 402
- GIRDER BRIDGES**, 32, 52, 84
- Continuous spans, 95, 302
  - Design, 52
  - Estimating cost, 297, 302
  - Examples, 118, 484
  - Single span, 84, 297
  - "    "    with cross beams, 93
  - Types, 29, 32
  - With fixed points of contraflexure, 116, 302
- Gradients, 236
- Glass, 453, 471
- GROUND** :
- Bearing pressures, 197, 203
  - Bearing tests, 15, 18
  - Borings, 13
  - Classification, 13
  - Investigation, 13
- Headroom, 7, 22
- HINGES**, 411
- Concealment, 240
  - In arches, 169, 189, 190, 214, 412
  - In continuous girders, 117
  - In portal frames, 145, 413
  - Temporary, 411
- Insurance, 427
- Joints, Construction, 460
- "    Expansion, 411, 461, 477
  - "    in continuous girders, 116, 239
- Kerbs, Precast concrete, 452, 465, 477
- Labour, 25, 431, 482
- Lamp standards, 242
- Length of bridges, 7, 45
- LOADS** :
- Concentrated on slabs, 56, 73
  - Effect on size of span, 48
  - Ministry of Transport, 53
  - On railway bridges, 401
  - Tests, 463
- Macadam, Bituminous, 452, 464, 479
- Mains, Provision for, 19
- Maintenance, 420, 422, 435, 442
- Margins, Covering and sowing, 465
- MATERIALS**, 432, 438, 449
- Available sources, 25
  - Prices, 482
  - Protection, 449
  - Quality, 432
  - Quantities, for various concrete mixtures, 382
  - Samples and tests, 432, 449
  - Supervision, 394
  - (See also particular materials)
- Measurement of quantities, 294, 440
- "    "    works, 400, 440
- Mineral workings, 18
- Ministry of Transport loads, 53
- "    "    "    recommendations, 109
  - "    "    "    requirements for estimates, 304
  - "    "    "    stresses, 55
- Moulds for precast concrete, 456
- Navigation rights, 7
- OFFICE PRACTICE**, 267
- Bills of quantities, 293
  - Calculations, 273
  - Checking drawings, 287
  - Drawings, 270, 273, 275
  - Routine, 267
- Specifications, 292
  - Steel sheets, 289
- Oil for shutters, 340, 457
- Ornament, 243
- Parapet blocks, Precast, 463
- Parapets, Architectural treatment of, 240
- Paving flags, 452, 477
- Piers, Architectural treatment of, 237
- Piles, Precast, 201, 462, 472
- "    Fittments for, 452
  - "    Stripping heads of, 463
  - "    Test, 462
  - "    Timber, 329
- Pipe-laying, 454
- Pitching, 452, 464, 479
- Plain concrete bridges, 420
- PORTAL-FRAME BRIDGES**, 134
- Estimating cost, 298, 301
  - Fixed, 146
  - Hinged, 134
  - Huges, 413
  - Types, 29, 33
- PRECAST CONCRETE** (see also Piles)
- Bridges, 406
  - Balustrades, 240
  - Coping, 240, 242, 463, 477
  - Kerbs, 452, 465, 477
  - Moulds, 456
  - Parapet blocks, 240, 463, 477
  - Paving flags, 452, 477
  - Quantities, 477
- Prices of materials and labour, 482
- "    Schedule of, 480
- Quantities, Bill of, 293, 467
- "    Measurement of, 294, 410
  - "    of concrete materials, 382
- Railway bridges, 401
- Realignment of existing bridges, 247
- REINFORCEMENT**, 356
- Bending, 360, 455
  - Bending schedule, 280, 290
  - Coupling boxes, 276
  - Cover to bars, 281, 455
  - Details, 268, 275
  - Fixing, 367, 397, 455
  - Hooks, 272, 281
  - Ordering, 358
  - Quantities, 476
  - Spacing, 281, 455
  - Specification, 450, 455
  - Steel sheets, 289
  - Storing, 359
  - Supervision, 396 —
  - Welding, 366
- Resident engineer's duties, 392, 423
- River, Flow of, 19
- ROADS** :
- Accommodation, 22
  - Alignment, 5
  - Approach, 45, 464
  - Bottom course, 452, 464
  - Drainage, 21
  - Foundation, 452, 464
  - Gradients, 236
  - Maintaining traffic, 23, 327
  - Quantities, 479
  - Secondary, 7
  - Surface and top course, 8, 452, 464
- Sand, 374, 395, 451
- Scarifying existing carriageway, 465, 479
- Service ducts, 8, 19

## INDEX

- Setting-out the works, 330, 427  
Shear in beams, 88  
Shearing resistance of diagonal bars, 88  
" " " stirrups, 91  
SHUTTERING, 338, 398, 456  
  Erection, 456  
  Examples, 341  
  For culverts, 407  
  For precast concrete, 456  
  Oil for, 340, 457  
  Quantities, 473  
  Removal, 461  
  (See also Centering and Staging)  
Site, 10, 423  
  " Access to, 432  
  " Clearance of, 431, 453, 468  
  " Possession of, 432  
  " survey and investigation, 10, 425  
Skew spans, 50  
Slab-and-girder bridges (see Girdler bridges)  
SLAB BRIDGES, 29, 33, 38  
  Continuous, 75, 83  
  Design, 52  
  Estimating cost, 297  
  Examples, 73  
  Portal frame, 135  
Slabs, Freely supported, 52  
  " supported on four sides, 60, 80  
  " supporting concentrated loads, 56, 80  
Slopes, Covering and sowing, 465, 471  
Slump test, 458  
Spandrel walls, Architectural treatment of, 210  
Span on loading, Effect of, 18  
  " Subdivision of, 7  
Specification, 292, 448  
Staging, 338, 340  
Steel-beam theory, 92, 104  
Strength of concrete bridges, 260  
Strengthening existing bridges, 247  
Subways, 403  
Supervision of construction, 392  
Surveys, 27  
Temporary bridges, 327  
  " works, 327, 423  
Tenders, 307, 424  
Testing bridges, 420, 463  
  " concrete, 378, 390, 458  
  " ground, 15  
  " materials, 432, 449, 458  
  " piles, 462  
Thrust and bending combined, 147  
Tides, Influence of, 21  
Towpath, Amenities of, 22  
Traffic, 23, 327, 330  
Trenches, Drain, 451  
Types of bridges, 28  
Variations of contract, 307, 437  
Walls, 242  
Water, 378, 383, 395, 452, 457  
Water levels, 440  
Waterproofing, 417  
Waterway, 7  
Widening existing bridges, 8, 247  
Width of bridges, 48  
Wind pressure, 417  
Workmanship, 432, 453

## ACKNOWLEDGMENTS

In addition to the engineers acknowledged on the drawings and elsewhere, acknowledgments are due to the following engineers, contractors, and others concerned with the bridges and equipment illustrated. In the case of public authorities, the name of the engineer at the time the bridge was constructed is given.

British Reinforced Concrete Engineering Co., Ltd., *Fig.* 346  
Carmarthen County Council (Mr. T. W. Wishlade, County Surveyor), *Figs.* 274, 275, 300  
Christiam and Nielsen, Ltd., *Fig.* 343  
Cleveland Bridge and Engineering Co., Ltd., *Fig.* 333  
Considère Constructions, Ltd., *Figs.* 274, 275, 300, 333, 348, 349,  
G. E. Everitt and Sons, Ltd., *Fig.* 332  
Glasgow City Council (Mr. T. Somers, City Engineer), *Figs.* 348, 349  
Holloway Bros (London), Ltd., *Figs.* 274, 275, 300  
A. Jackaman and Son, Ltd., *Fig.* 302  
Peter Lind and Co., Ltd., *Fig.* 363  
London County Council (Engineer: Sir Pierson Frank), *Figs.* 351, 352  
Mr. Robert Lowe, *Fig.* 279

P. Lync, Ltd., *Fig.* 297  
Middlesex County Council (Mr. A. Dryland, County Engineer), *Figs.* 302, 332, 333  
Mouchel & Partners, Ltd., *Figs.* 302, 332, 343  
Northshire County Council (Colonel P. M. Cram, County Engineer), Illustration on *page* iv  
Norfolk County Council (Major S. H. Warren, County Surveyor), *Fig.* 356  
Ransomes and Rapier, Ltd., *Figs.* 280, 281  
Rendell, Palmer and Tritton, *Figs.* 340, 351, 352  
Stirling Burgh Council (Mr. D. B. Marrs, Borough Surveyor), *Fig.* 353  
Stirlingshire County Council (Mr. D. R. Cox, County Surveyor), *Fig.* 347  
Aubrey Watson, Ltd., *Fig.* 268  
West Riding County Council (Mr. H. R. Hepworth, County Surveyor), *Figs.* 297, 338, 339, 341, 342

## “ CONCRETE SERIES ” BOOKS on CONCRETE and CEMENT

Detailed prospectuses sent on request. The dates are the year of publication of the latest edition or impression. Prices in Canada and U.S.A. are given in dollars

- Reinforced Concrete.** BAKER. 1949. 304 pp. 15s.; by post 16s. 3d. (\$3.50.)
- Prestressed Concrete.** MAGNEL. 1954. 350 pp. 20s.; by post 21s. 4d. Customers in America must obtain the American edition from McGraw-Hill Book Company, Inc., New York 36, and Toronto.
- Ultimate Load Theory Applied to the Design of Reinforced and Prestressed Concrete Frames.** BAKER. 1956. 18s.; by post 19s. (\$4.)
- Theory and Practice of Structural Design Applied to Reinforced Concrete.** ERIKSEN. 1953. 408 pp. 25s.; by post 26s. 2d. (\$5.50.)
- Explanatory Handbook on the B.S. Code of Practice for Reinforced Concrete.** SCOTT, GLANVILLE, and THOMAS. 1950. 128 pp. 9s.; by post 9s. 8d. (\$2.10.)
- The Elements of Reinforced Concrete Design.** ADAMS. 1950. 154 pp. 6s.; by post 6s. 8d. (\$1.50.)
- Analysis of Structures.** SMOLIRA. 1955. 176 pp. 18s.; by post 19s. (\$4.)
- Design of Prismatic Structures.** ASHDOWN. 1951. 64 pp. 8s.; by post 8s. 6d. (\$1.90.)
- Design and Construction of Reinforced Concrete Bridges.** LEGAT, DUNN, and FAIRHURST. 1948. 528 pp. 36s.; by post 37s. 9d. (\$6.80.)
- Reinforced Concrete Designer's Handbook.** REYNOLDS. 1954. 360 pp. 18s.; by post 19s. 2d. (\$4.)
- Examples of the Design of Reinforced Concrete Buildings.** REYNOLDS. 1952. 224 pp. 10s.; by post 11s. (\$2.40.)
- Reinforced Concrete Water Towers, Bunkers, Silos and Gangeries.** GRAY. 1953. 224 pp. 12s.; by post 12s. 10d. (\$2.80.)
- Reinforced Concrete Reservoirs and Tanks.** GRAY. 1954. 176 pp. 12s.; by post 12s. 10d. (\$2.80.)
- Reinforced Concrete Piling.** WENTWORTH-SHEILDS and GRAY. 1948. 128 pp. 10s.; by post 10s. 8d. (\$2.40.)
- Reinforced Concrete Chimneys.** TAYLOR and TURNER. 1948. 64 pp. 10s.; by post 10s. 8d. (\$2.40.)
- Arch Design Simplified.** FAIRHURST. 1954. 68 pp. 12s.; by post 12s. 9d. (\$2.80.)
- Sheet Piling, Cofferdams, and Caissons.** LEE. 1949. 200 pp. 10s.; by post 11s. (\$2.40.)
- The Displacement Method of Frame Analysis.** MANNING. 1952. 128 pp. Price 9s.; by post 9s. 8d. (\$2.10.)
- Continuous Beam Structures. A DEGREE OF FIXITY METHOD AND THE METHOD OF MOMENT DISTRIBUTION.** SHEPLEY. 1950. 122 pp. 8s. 6d.; by post 9s. 2d. (\$2.)
- Stationally Indeterminate Structures.** GARTNER. (New Edition 1957.) \*
- Road Bridges in Great Britain.** (Descriptions of 96 reinforced concrete bridges.) 1951. 168 pp. 9s.; by post 9s. 8d. (\$2.10.)
- Raft Foundations: The Soil-Line Method.** BAKER. 1948. 150 pp. 8s.; by post 8s. 8d. (\$1.90.)
- Design of Arch Ribs for Reinforced Concrete Roofs.** TERRINGTON. 1957. 28 pp. 4s.; by post 4s. 4d. (\$1.)
- Design of Domes.** TERRINGTON. 1957. 28 pp. 4s.; by post 4s. 4d. (\$1.)
- Design of Pyramid Roofs.** TERRINGTON. 1957. 20 pp. 4s.; by post 4s. 4d. (\$1.)
- Influence Lines for Thrust and Bending Moments in the Fixed Arch.** ERIKSEN. 1955. 25 pp. 4s.; by post 4s. 3d. (\$1.00.)
- Design and Construction of Concrete Roads.** SMITH and GRIGSON. 1946. 168 pp. 8s. 6d.; by post 9s. 6d. (\$2.)
- Estimating and Cost Keeping for Concrete Structures.** WYNN. 1949. 222 pp. 15s.; by post 15s. 10d. (\$3.50.)
- Design and Construction of Formwork for Concrete Structures.** WYNN. 1956. 304 pp. 24s.; by post 25s. 4d. (\$5.25.)
- Construction with Moving Forms.** HUNTER. 1951. 64 pp. 7s. 6d.; by post 8s. (\$1.75.)
- Concrete Farm Structures.** PENNINGTON. 1954. 152 pp. 12s.; by post 12s. 10d. (\$2.80.)
- Concrete Construction.** REYNOLDS. 1950. 488 pp. 15s.; by post 16s. 6d. (\$3.50.)
- How to Make Good Concrete.** WALSH. 1955. 128 pp. 8s.; by post 8s. 10d. (\$1.90.)
- Introduction to Concrete Work.** CHILDE. 1952. 144 pp. 3s.; by post 3s. 3d. (\$0.80.)
- Steel Reinforcement: Cutting, Bending, and Fixing.** DISNEY. 1954. 74 pp. 6s.; by post 6s. 6d. (\$1.50.)
- Concrete Surface Finishes, Rendering and Terrazzo.** GRAY and CHILDE. 1948. 128 pp. 8s. 6d.; by post 9s. 2d. (\$2.) \*
- Concrete Construction Made Easy.** TURNER and LAKEMAN. 1948. 118 pp. 5s.; by post 5s. 6d. (\$1.25.)
- Elementary Guide to Reinforced Concrete.** LAKEMAN. 1950. 96 pp. 3s.; by post 3s. 4d. (\$0.80.)
- The Concrete Year Book. A Handbook, Directory and Catalogue.** Edited by FABER and CHILDE. Revised every year. 10s.; by post 11s. 6d. (\$2.40.)
- Concrete Houses and Small Garages.** LAKEMAN. 1949. 156 pp. 8s. 6d.; by post 9s. 6d. (\$2.)
- Concrete Products and Cast Stone.** CHILDE. 1949. 272 pp. 8s. 6d.; by post 9s. 9d. (\$2.)
- Moulds for Cast Stone and Concrete Products.** BURREN and GREGORY. With designs for garden ware. 1957. 96 pp. 6s.; by post 6s. 6d. (\$1.50.)
- Manufacture of Concrete Roofing Tiles.** BAUMGARTEN and CHILDE. 1947. 96 pp. 7s. 6d.; by post 8s. (\$1.75.)
- Concrete Fences.** PENNINGTON. 1950. 64 pp. 6s.; by post 6s. 6d. (\$1.50.)
- Estimating and Costing Precast Concrete Products and Cast Stone.** FIELDER. 1947. 140 pp. 7s. 6d.; by post 8s. (\$1.75.)
- Portland Cement.** DAVIS. 1948. 340 pp. 30s.; by post 31s. 6d. (\$6.80.)
- Cement Chemists' and Works Managers' Handbook.** WATSON and CRADDOCK. 1952. 228 pp. 25s.; by post 26s. (\$5.50.)
- Concrete and Constructional Engineering.** Price 1s. 9d. monthly. Annual subscription 21s. (\$3.90.)
- Concrete Building and Concrete Products.** Price 6d. monthly. Annual subscription 6s. (\$1.30.)
- Cement and Lime Manufacture.** Price 1s. Alternate months. Annual subscription 6s. (\$1.30.)